

How to win your mind wars...

Richard A. Panzer

August 20, 2018

World Peace and Unification Sanctuary - USA



I, Paul, myself entreat you, by the meekness and gentleness of Christ-I who am humble when face to face with you, but bold to you when I am away! I beg of you that when I am present I may not have to show boldness with such confidence as I count on showing against some who suspect us of acting in worldly fashion. For though we live in the world we are not carrying on a worldly war, for the weapons of our warfare are not worldly but have divine power to destroy strongholds. We destroy arguments and every proud obstacle to the knowledge of God, and take every thought captive to obey Christ, being ready to punish every disobedience, when your obedience is complete.

2 Corinthians 10:1-6 RSV

Through establishing a nation of God, we are to establish on earth the peaceful Kingdom of Heaven that places good above all else, that eliminates evil and judges the ringleader Satan, who, until now, has been the enemy of Heaven. Please understand that this has been the desire of our ancestors, who contributed enormously to the course of the providence, as well as the desire of God and Jesus. (155-321, 1965.11.1) CSG Book 13 "Restoration of the True God's Homeland"

Dear

In Sunday's powerful and spirit-filled message, Hyung Jin Nim explained how couples and families should be like a heavenly "swat team" against Satan. A woman who protects her husband's anointing is a Godly woman. She can say to her children, "I practice what I preach." Then her children will respect her. God did not say, "when you feel like respecting him or loving her, then you should do that." The heavenly crown is not just based on emotions but on practicing a Godly standard. The more wives believe in their husbands the more confidence he will have, even when he doesn't believe in himself. The wife has that Godly power to speak blessings on him. Also to encourage herself through reading God's word. If her husband also is a Godly man rooted in the Word, then so much easier for her.

Yeonah Nim and I have been blessed to be in the top 1% of couples. We made a lot of effort, but God blessed us. Some wallow in their "suffering" and believe that their marriage is doomed to fail because their parents' marriages were difficult. They self-sabotage themselves by believing the lie and not basing their marriage on the word of God. He challenged the young people to say, "my marriage is going to be a high-level marriage!" God wants to bless you, that's why it's called the "Blessing," not the "cursing!" Say "I will not believe the wiles of the devil!"

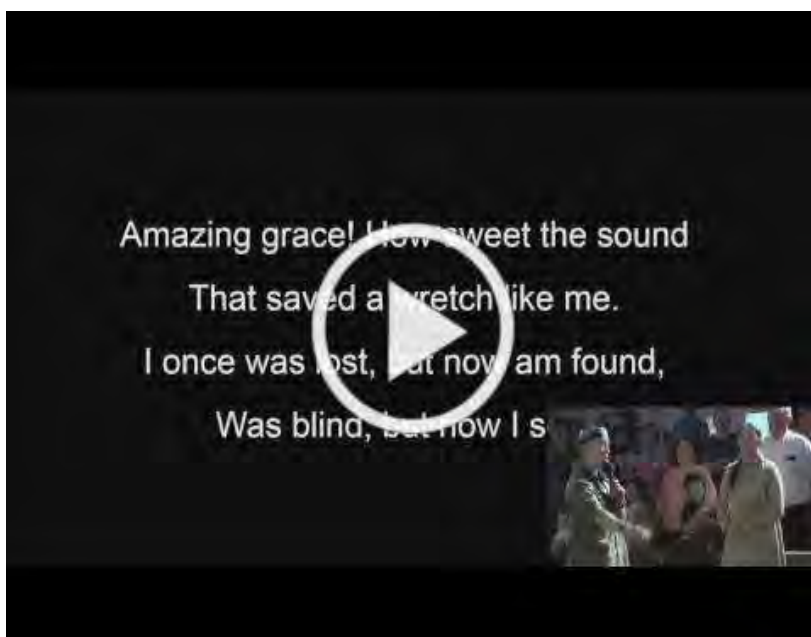

Sanctuary Church Sunday Service 08/19/18 - YouTube

God is fair. If you believe the lies of the devil, the fruits of the devil are your reward: delusion, confusion, anxiety, depression and hell. Like spiritual "Zanex" with all kinds of harmful or even deadly side effects.

But God has given you the power of a sound mind. Say, "shut up, devil!" Bring negative thoughts into "captivity." Lock them up!

The Word of God is powerful and alive! Cast out the lies in your mind, which say you will be a failure. Don't submit yourself to a false king, actually a demon inside you! As Jesus said, no parent would give their child a poisonous snake, so how much more God wants to give you a beautiful, successful, powerful marriage and life.

You are meant to be fruitful, multiply and have dominion over the earth! Flush those negative thoughts out of your mind and heart! Move in a Godly way. You honor God by investing in your husband or wife and in your children. Arguments happen, just rise above them. Don't let them be "evidence" for a false belief.

The Bible says that no weapon formed against you shall prosper. You will be high quality husbands and wives. Your children will be so blessed to have you as a daddy or mommy. That is the promise that is over you. Hold on to God while He takes you on a journey. You will have the blessings of Abraham. That doesn't mean you won't have challenges. Say "this is just one of the trials and tribulations. I will be able to step on the devil like the snake that he is."

Miho, my daughter Misha, and I has a wonderful time visiting the Sanctuary community in Worcester, MA yesterday!



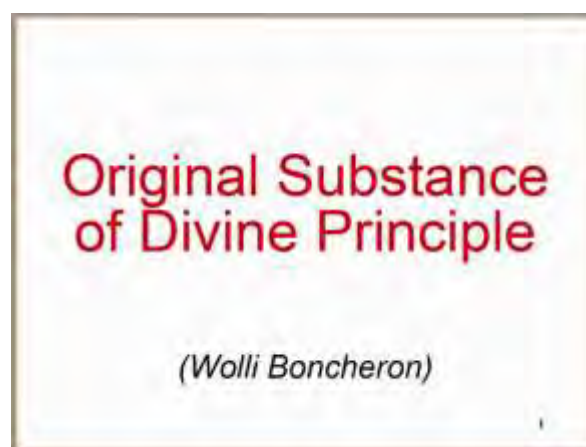

[Download and Study the English OSDP Presentation!](#)

May God bless you and your families!

Sincerely,

Richard

Richard A. Panzer, Ph.D., President
World Peace and Unification Sanctuary - USA

Original Substance of Divine Principle

(Wolli Boncheron)

Family Pledge

The Family is...

- God's ideal of creation
- The basic unit of the Kingdom of Heaven
- The training ground for *shimjung* and true love that allows us to be registered in the Kingdom of True Love
- The core body where tri-generational love is unified
- The basic unit of order for society and nation
- Absolute Sex (Realm of True Love, True Life and True Lineage) → Sexual Purity, Purity of Lineage, Purity of Love

Accordingly, the True Family is the Eternal Homeland of Humankind.

The Family Pledge is...

- The backbone, the core and the order of the family
- The absolute standard for realizing Cheon Il Guk and the core of its constitution
- The gospel of gospels for connecting our lives with God
- The key for opening the gate of the Kingdom of Heaven
- The prayer of prayers
- The blessing of blessings, given by Heaven to humankind
- The Family Pledge is the record of the victories won during the life of the True Parent.

The Family Pledge is comprised of eight verses.

Family Pledge Verse 1

- i. Our family, the owner of Cheon Il Guk, pledges
- ii. to seek our original homeland and
- iii. build the Kingdom of God on earth and in heaven,
- iv. the original ideal of creation, by centering on true love.

Owner

- Takes interest (I am the owner)
- Takes responsibility
- Protects
- Nurtures

Family Pledge Verse 2

- i. Our family, the owner of Cheon Il Guk,
- ii. pledges to represent and become central to heaven and earth
- iii. by attending God and True Parents; we pledge to
- iv. perfect the dutiful family way of filial sons and daughters in our family, patriots in our nation,
- v. saints in the world, and divine sons and daughters in heaven and earth, by centering on true love.

Family Pledge Verse 3

- i. Our family, the owner of Cheon Il Guk,
- ii. pledges to perfect the Four Great Realms of Heart,
- iii. the Three Great Kingships,
- iv. and the Realm of the Royal Family, by centering on true love.

Family Pledge Verse 4

- i. Our family, the owner of Cheon Il Guk,
- ii. pledges to build the universal family encompassing heaven and earth,
- iii. which is God's ideal of creation,
- iv. and perfect the world of freedom, peace, unity and happiness, by centering on true love.

Family Pledge Verse 5

- i. Our family, the owner of Cheon Il Guk,
- ii. pledges to strive every day to advance
- iii. the unification of the spirit world and the physical world
- iv. as subject and object partners, by centering on true love.

Family Pledge Verse 6

- i. Our family, the owner of Cheon Il Guk,
- ii. pledges to become a family that moves heavenly fortune
- iii. by embodying God and True Parents,
- iv. and to perfect a family that conveys Heaven's blessing to our community, by centering on true love.

Family Pledge Verse 7

- i. Our family, the owner of Cheon Il Guk,
- ii. pledges through living for the sake of others,
- iii. to perfect the world based on the culture of heart,
- iv. which is rooted in the original lineage, by centering on true love.

Family Pledge Verse 8

- i. Our family, the owner of Cheon Il Guk,
- ii. pledges, having entered the Completed Testament Age,
- iii. to achieve the ideal of God and human beings united in love,
- iv. through absolute faith, absolute love and absolute obedience,
- v. and to perfect the realm of liberation and complete freedom in the Kingdom of God on earth and in heaven, by centering on true love.

Reasons to Study the Theory of the Original Substance of Divine Principle

I. Resolving all the problems in the real world

1. Problems in Today's World

- (1) **View of God** (life ▪ marriage ▪ nation ▪ world ▪ universe ▪ history)
- (2) **View of human life** (mind and body ▪ conflict ▪ confrontation ▪ struggle)
Family breakdown (divorce, infidelity), Teenage and young adult immorality, homosexuality, same-sex marriage, AIDS, school violence, labor-management relations, racial discrimination, international borders, religious conflict, environmental pollution, food shortages, ideological issues (philosophy, democracy - communism), Global problems (Asia, Middle East), Peace & Unification Issues (war, malnutrition, disease, education)
- (3) **Spirit World** problems
- (4) **Fundamental issues of philosophy** (existence and relationships)

(5) **The problem of a true value system**

- i. Value system – how do we see right and wrong? (good/evil, true/false, truth/untruth)
- ii. If the value system is different, these are different:
thoughts → judgment → claims → decisions → life & practice
(e.g. North & South Korea → value system is different)

(6) **The issue of a peaceful unified world**

- i. Human beings long for freedom, equality, peace, unity, happiness
Where does a peaceful unified world begin?

From the world → family → individual OR

From the individual → family → world ?

It starts from me.

Unity of individual's mind/body → peaceful world realized thru true families ii.

Peaceful unified world

war, starvation, disease, education, freedom, equality, happiness

(7) **The problem of a true view of human nature**

- i. Know the true me. Who / what am I? (Am I a true person? A false person?)
- ii. We must reveal the position and nature of original human beings (of the original creation) and fallen human beings.

2. How did these problems come into being?

(1) Due to the Fall of the Human Ancestors

- i. If Adam and Eve had believed in God's Word and practiced it to become complete, they would have become True Parents and the world of God's Ideal of Creation would have been completed (The Three Blessings – Gen 1:28).
This perfectly completed world would not have the problems we see today.
- ii. Because of the Fall, Adam and Eve failed to become True Parents and instead became false parents. They formed a false family, resulting in the evil world on earth and in heaven, the cause of all problems. Humankind, born from false parents, is unable to solve the real world problems that have resulted from the Fall. Why? Because humankind, born as descendants of the fallen Adam and Eve, lost their connection with the true God and instead were born centering on the false god, Satan.
Accordingly, humankind are orphans who have lost their True Parent.

iii. Because the True Parent came and accomplished the Holy Marriage of True Parents, the true parent ideal was initiated for the first time since the creation of the world, bringing about the completion of the ideal of creation. However, he could only manifest as the substantial True Parent and bring God's ideal of creation to completion (the declaration of Foundation Day) after using the principle of indemnity to restore the vertical and horizontal eight stages established by the false parents, and fighting against myriads of satans on earth and in the spirit world to bring Satan to voluntary surrender.

The satanic world began centering on Satan when Adam and Eve fell by means of illicit love to become false parents in the beginning. The world of God's ideal of creation centers on God and comes into being when OSDP Absolute Sex education is carried out according to the True Parent's teaching.

Accordingly, all the world's problems will be resolved and the ideal world of Cheon Il Guk will be accomplished centering on True Parents.

This is the most important reason to study the Original Substance of Divine Principle.

(2) What Kind of Being is a Fallen Human?

- i. Contradictory being, womb of good and evil, unprincipled being, fallen nature, original sin
- ii. Mind-body conflict, confrontation and struggle

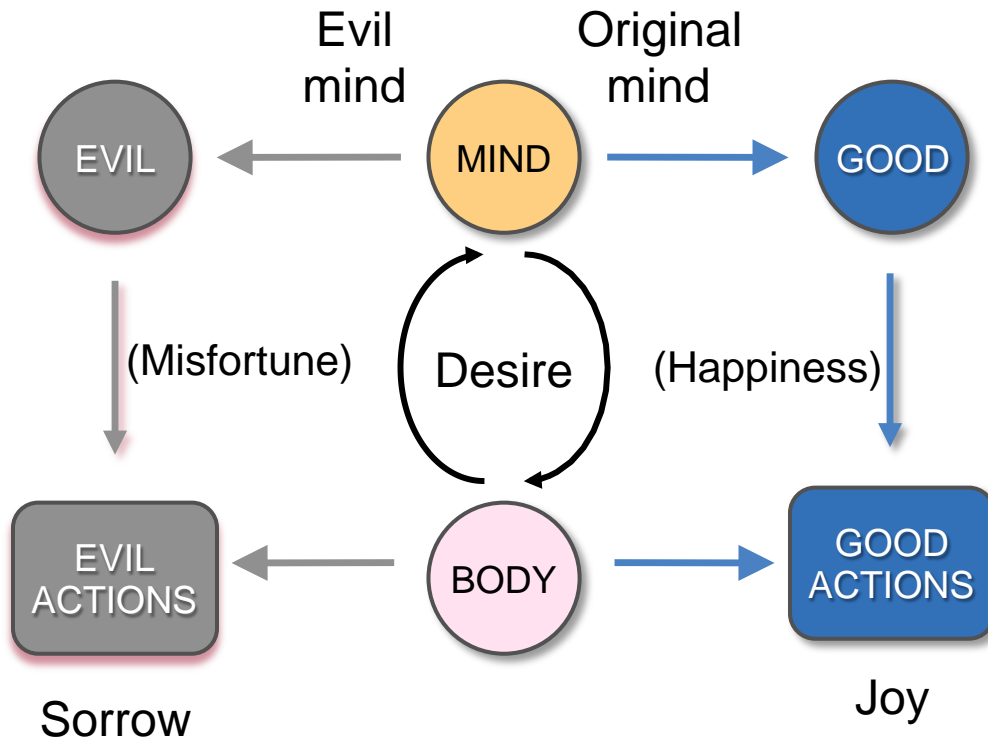

Contradictory being
Womb of good and evil
Unprincipled being
Fallen nature, original sin

Romans 7:17-25
1 John 1: 8-10
Romans 3:10-11
1 Thess 5:17

iii. Spiritually and physically ignorant humans

Humans are ignorant in spirit and in intellect

- God - True Parent - spirit world - portion of responsibility, purpose of creation, true family, sin and restoration through indemnity

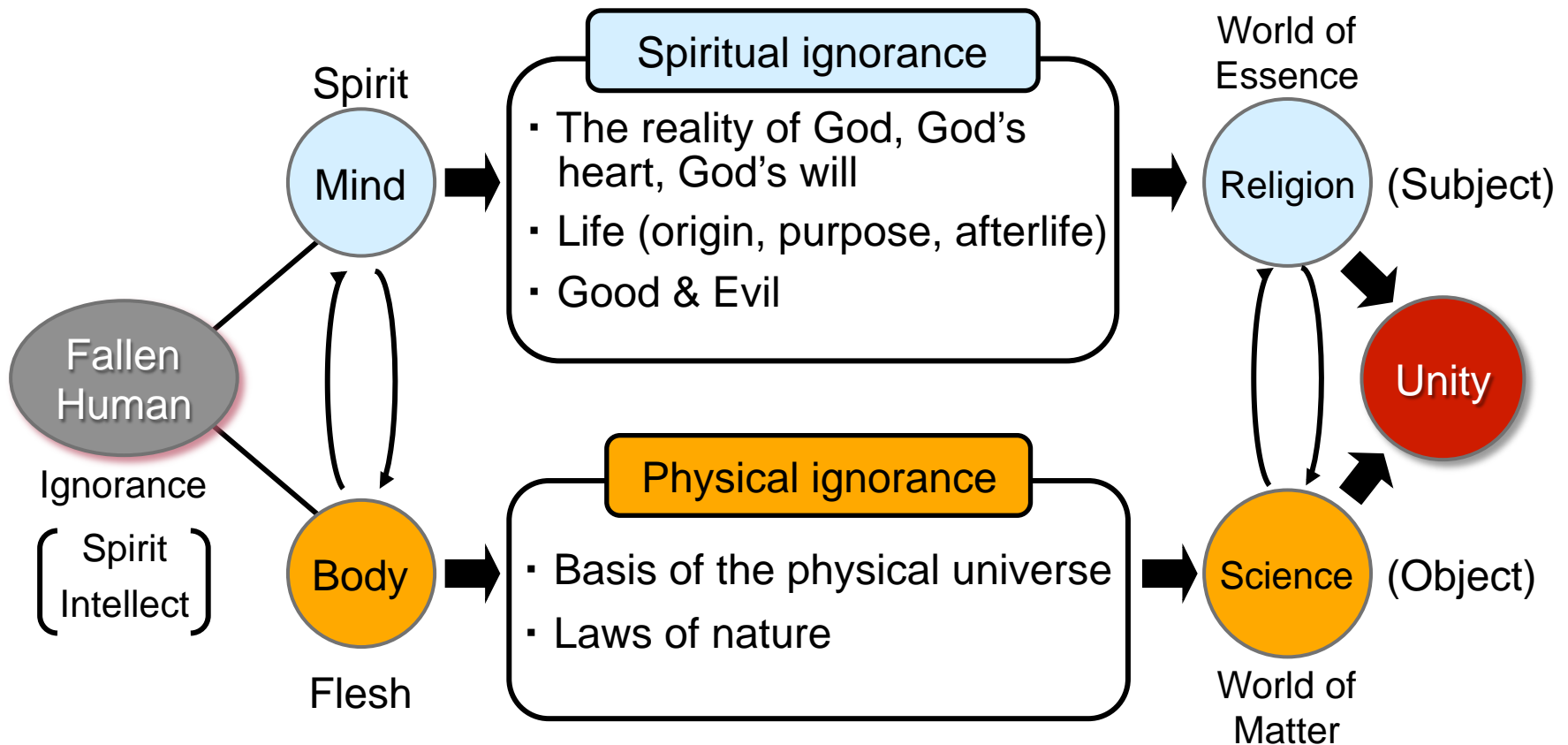

(3) Religion and Science

Philosophy: Academic field proving God's existence (foundation of universe)

Religion: Revealing how to live attending God

i. Religion

No need for religion in the original world

Fallen man needs religion

What is the state of religion today?

a. Religion today: Unable to fulfill its responsibility

- Emphasis on the next world → Satisfied with material reality
- Incomplete doctrines (unable to solve real-world problems)
- Ignorance of God's providence (loss of heavenly fortune)



I am the bridegroom
God is my father
I am His son (only begotten son)[†]
(No actual bride, could not establish the ideal of the family)

b. Christianity

Became a world religion by professing salvation of humankind

Lost its fundamental mission as a religion

- i. Should dispel ignorance of the mind and help people to understand God's providence: Could Not Fulfill
- ii. Fulfill mission of the bride who receives the Messiah: Could Not Fulfill

Christianity unable to fully explain the Father - son relationship
Christian world still afflicted with family breakdown & immorality
Could not demonstrate the ideal of world brotherhood

- iii. Be the salt and light of the world (Matt 5:13-16): Could Not Fulfill
(Worldly ways penetrated the church {religion}; church was secularized)

iv. Christianity: could not fulfill the mission of religion

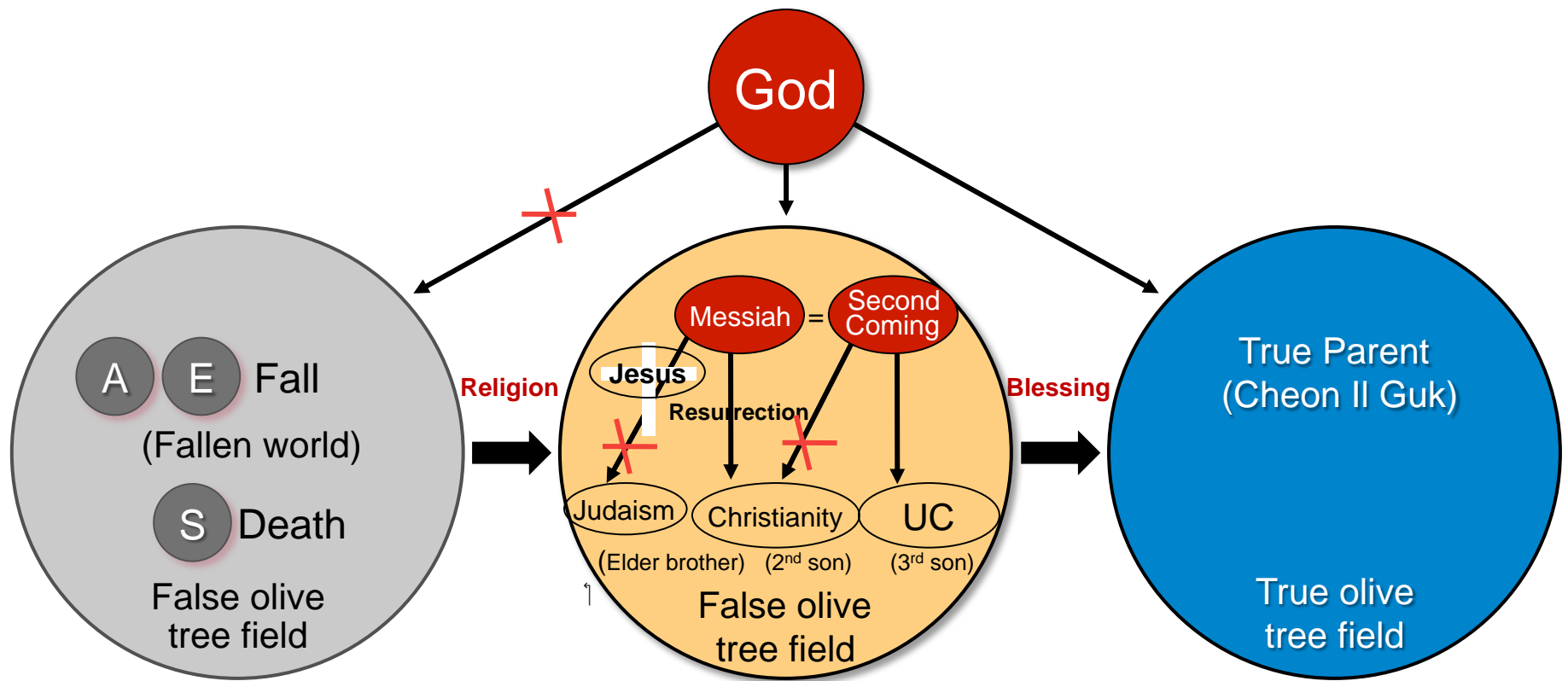

Rom11:17 - The Messiah comes and cuts off the wild olive trees and engrafts them with the True olive tree.

We do not receive salvation (rebirth) from a religion by believing in religion. Rather, we receive salvation through the Blessing (true love) by believing in (attending) the Messiah (the True Parent).

- v. Lost the ability to take action
(lost the ability to act and the power to persuade due to inadequate ideology)

- vi. Became a religion of rituals and institutions
(lost its sense of direction concerning God's providence)

- vii. Became an expedient way of living
(indifferent to the realization of God's ideal)

- viii. Lost the spirit of the early church
(lost the fire of the Religious Reformation) ♪

ii. Science

- a. Object of research: Something (form) → Nothing (no form)
- b. Has come up against its own limitations
- c. Because science has been developed by ignoring the question of values, humankind has obtained a far more convenient lifestyle but has also suffered great damage.

3) The Reasons Why We Cannot Solve All Problems

- (1) We try to solve the problems while denying the Creator.
- (2) Even when believing in God, we fail to place God at the center, and instead try to solve problems centering on ourselves.
- (3) Because, as human beings, we avoid acknowledging that we ourselves are fallen beings

Our leaders tried hard to solve our problems, but the fundamental problems remain unresolved.

2. How Should We Solve Problems?

1) Through Education

(1) Unification Principle

(2) OSDP and Absolute Sex Education

2) We must believe in God's word, practice it and live by it.

3. Appearance of the Unification Principle from the Perspective of Providence

1) From the perspective of providential era
(development of spirit and intellect)

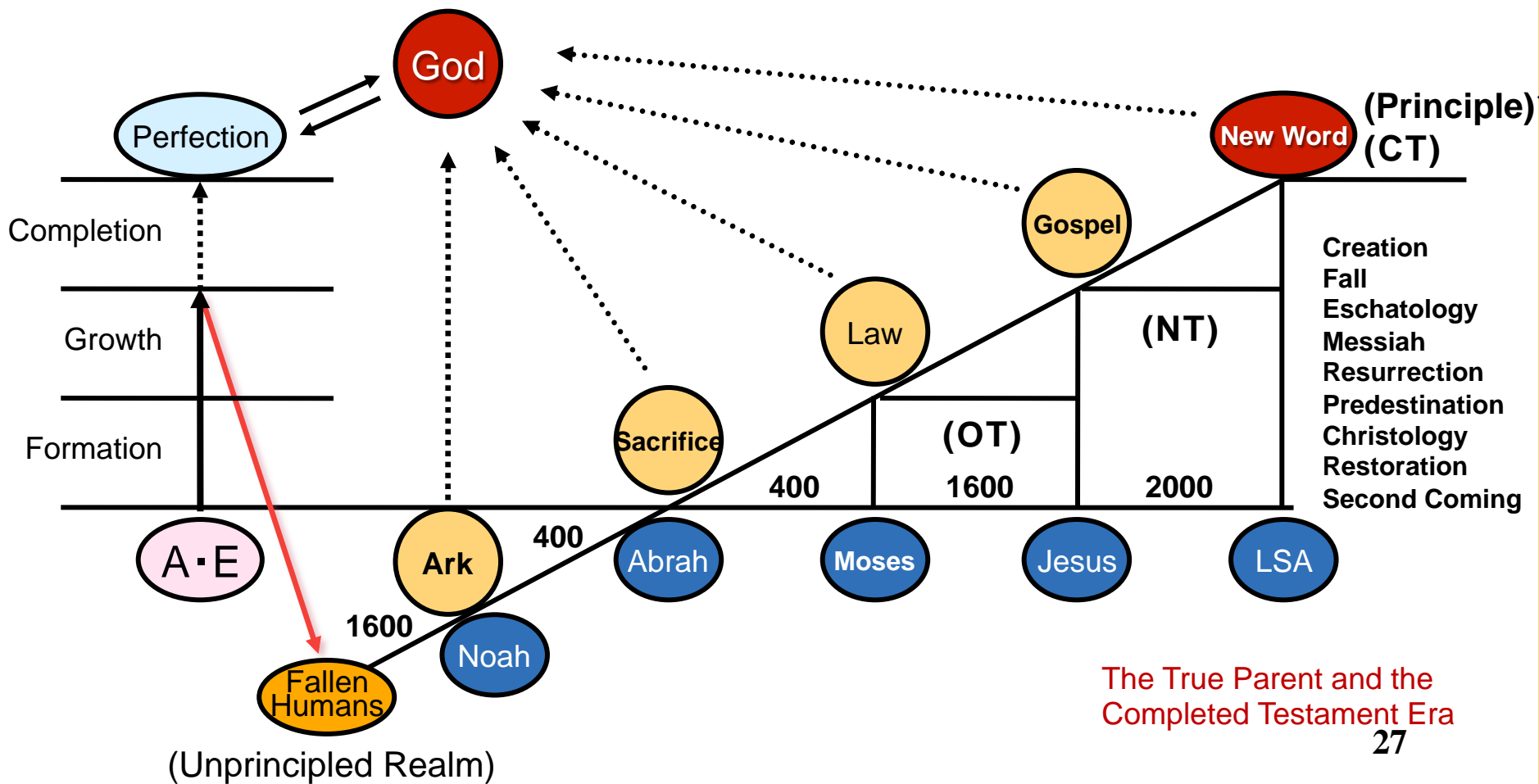

2) From the Viewpoint of the Bible (biblical basis)

(1) John 16:25

These things have I spoken unto you in proverbs: but the time cometh, when I shall no more speak unto you in proverbs, but I shall show you plainly of the Father.

(2) John 16:12

I have yet many things to say unto you, but ye cannot bear them now.

(3) John 16:13

But when he, the Spirit of truth, comes, he will guide you into all the truth. He will not speak on his own; he will speak only what he hears, and he will tell you what is yet to come.

(4) Rev 10:10-11

Thou must prophesy again before many peoples, and nations, and tongues, and kings.

(5) Luke 5:38 New wine must be put into fresh wineskins.

4. Background to the Emergence of the Unification Principle and OSDP

1) Background to Emergence

Rev. Sun Myung Moon reveals the '*wolli wonbon*' ('Original Manuscript of the Principle'), which is the basis of the Unification Principle.

(May 10, 1951 - May 11, 1952)

August 15, 1957 – (5 years later) '*wolli haeseol*' ('Explanation of the Principle'), which systematically explains the Unification Principle, published.

May 1, 1966 – (9 years later) '*wolli kangnon*' (Exposition of the Principle), outlining the Unification Principle in a systematized lecture format, published.

October 10, 2008 – (42 years later) '*wolli boncheron*' (OSDP 'Teaching of the Original Substance of Divine Principle') presented.

November 28, 2008 – First publication of OSDP manual

April 5, 2012 – (HC 3.15) '*wolli boncheron*' ('Teaching of the Original Substance of Divine Principle') published.

April 9, 2015 – (HC 3.1) Revised and enlarged edition published

2) *Wolli Wonbon*

Wolli Haeseol (EP)	=	Formation-stage Principle	=	Symbolic Principle
Wolli Kangnon (EDP)	=	Growth-stage Principle	=	Image Principle
OSDP	=	Completion-stage Principle	=	Substantial Principle

(3) Structure of *Wolli Boncheron* (OSDP)

Part I = 7 Chapters; Part II = 7 Chapters (799 pages)

II. How Will We Realize a Unified World of Peace?

1. Realization of the Universal Family Encompassing Heaven and Earth that is God's Ideal of Creation (Realizing the Cheon Il Guk Family)

- 1) Realize the ideal of true families centered on True Parents (absolute sex ▪ absolute purity ▪ absolute sexual organs)
- 2) Clarify the basis of democracy and communism (unification of ideology)
- 3) Unify science and religion (realize a unified world of peace)
- 4) Solve the basic problems of the Bible (unite denominations and religions)
- 5) Guide humanity to become God's true children (absolute sex, shimjung, substance)
- 6) Restore God's homeland (All humanity becomes blessed families in Cheon Il Guk)

2. In order to Realize a Unified World of Peace

- 1) Know God with certainty
- 2) Know the Spirit World with certainty
- 3) Know True Parents with certainty
- 4) Know with certainty that we are fallen human beings (sinners)
- 5) Know the Principle of Restoration through Indemnity with certainty
- 6) Know the human portion of responsibility with certainty

III. Conclusion

Ultimate Purpose of the Bible -

To receive the Messiah

Ultimate Purpose of the Principle -

To receive the Messiah, believe in and attend the Messiah

To accept the teaching of the Messiah, become a true child of God, and complete God's purpose of creation

True Father revealed Unification Thought (UT) and Victory over Communism (VOC) Theory on the basis of Unification Principle.

The Unification Principle is not the mere doctrine of Unificationism. Rather, it is the heavenly path and principle that all people must know and live by.

The Crown of Glory

Father wrote this prayer poem in 1935, at the age of 15 (Korean 16).
Father wrote as follows in a book where this prayer poem was published:
“On Easter Sunday morning in the year I turned 16, I met God. From that day forward, I walked the path of God’s Will according to the instructions of Heaven in order to accomplish the Will of God.”

When I doubt people, I feel pain.
When I judge people, it is unbearable.
When I hate people, there is no value to my existence.

Yet if I believe, I am deceived. If I love, I am betrayed.
Suffering and grieving tonight, my head in my hands.
Am I wrong? Yes I am wrong.

Even though we are deceived, still believe,
Though we are betrayed, still forgive.
Love completely, even those who hate you.

Wipe your tears away and welcome with a smile
Those who know nothing but deceit,
And those who betray without regret.

O, Master, the pain of loving.
Look at my hands.
Place your hand on my chest.
My heart is bursting, such agony.

But when I love those who acted against me,
I brought victory.
If you have done the same things,
I will give you the Crown of Glory.

Sun Myung Moon, 1935

Principle of Creation

Introduction

1. What is the Principle of Creation?

Blueprint for creation established by God, the Creator of human life and the universe
To understand life and the universe, we must know God with clarity and certainty.

1) Way to live properly (design blueprint)

- { Objects – way to use (must use according to design) - 100V or 220V
- { Humans – way to live (must live according to the Principle of Creation)

2) Functional human beings – those who live in accordance with the Principle of Creation
Dysfunctional human beings – those who do not live in accordance with the Principle of Creation (defective humans, severely ill patients)†

3) When is purpose determined?

- { Objects – when manufactured in a factory (design blueprint)†
- { Humans – at the time of creation (Principle of Creation)

The Unification Principle is not mere religious dogma;
it is a true principle which all people need to know and live by.

2. Does God Exist?

If God exists, how did He come to exist? What kind of being is God? We know that all beings in the universe were created by God. Then **how did God the creator come to exist?** No one has been able to provide detailed, accurate answers to these questions. As a result, atheistic and materialist philosophies have appeared, giving rise to **atheistic and materialist** ideologies. These ideologies stand in opposition to **theistic and spiritual** ideologies, resulting in a dysfunctional world full of **dualistic conflict, confrontation and struggle**. The world of **peace, freedom, unity and happiness** that God intended to create has not been realized.

In addition, because God has been denied, a stream of thought has emerged asserting the theory of evolution, which itself denies the act of creation by God. This has resulted in the view that human beings, the Lords of Creation, are nothing more than animals, and has brought about an unprincipled and immoral world of evil where **sex has become a commodity** and **an instrument of hedonistic pleasures**. The result is confusion and chaos in what originally should be most precious and important – the sexual culture of humankind. For this reason, it is critical that we have an accurate and detailed understanding of God's nature.

This is why the Bible teaches that knowledge of God is the foundation of all understanding. The problem is, fallen human beings cannot accurately know God.

The only ones who can know God precisely are God himself and his son, the Messiah. For this reason, God, who is the incorporeal original root, said He would send His son as the returning Messiah.

When the returning Lord comes as God's son, he will teach us precisely about our Heavenly Father and clearly guide us how to connect with God so that we may become God's true children who resemble our Father's **original nature and original form**.

Rev. Sun Myung Moon is the True Parent of humankind. He fought and overcame the myriads of Satanic forces on earth and in the spirit world. Through the *Wolli Boncheron* – the **Theory of the Original Substance of Divine Principle** – that centers on the Unification Principle he discovered and revealed, he is teaching us about the precise and concrete reality of God for the first time in history, hitherto unrevealed and unknown by humankind.

3. What kind of Being is God?

When this question is asked, the content of both the question and the answer inevitably relates to the attributes of God. Traditional Christianity says that God is the Creator, that He is omniscient, omnipotent and omnipresent, that God is absolute, that God is true, and that God is the Lord of judgment and a God of love.

OSDP affirms that these are indeed God's attributes. However, if this remains the extent of our understanding of the attributes of God, we will be unable to find fundamental solutions to the complex problems of the real world in which we live our lives each day.

Why? The reason lies here: although humanity was created in the image of God, the ancestors of humanity, Adam and Eve, fell into sin during their growing period and became children of Satan who have no relationship whatsoever with God's creation ideal. As a result, the real world in which we live is a world of evil centered on Satan.

To bring about the original world of goodness created by God, we must become true human beings who resemble God's **original nature and original form**, and form true families, which are the ideal of God's creation. Because this is the only way in which we can solve the problems of this physical world, we need to know about God concretely and precisely.

As was mentioned in the introduction, *Wolli Boncheron* – the ‘Theory of the Original Root Substance of Principle’ - brings a fundamental resolution to the complex problems of today’s world, making it possible for us to realize the world of God’s creation ideal.

The most important reason allowing *Wolli Boncheron* (OSDP) to make this claim is that OSDP explains God’s attributes both concretely and precisely.

The section of OSDP that deals concretely with God’s attributes is called the Principle of Creation. Within the Principle of Creation, the first section (chapter) deals directly with the attributes of God, illustrating the importance of a principled explanation of God’s existence.

I. God's Dual Characteristics and the Created Universe

(I.) The Dual Characteristics of God

1. *Wolli Kangnon (Exposition of the Divine Principle)* explains the dual characteristics of God in two parts:

The first explains that God is the unique being Hananim, who is the harmonious unified body of original internal character (OSS) and original external form (OHS).

The second explains that God, as the harmonious unified body of original positivity (yang nature) and original negativity (yin nature), is the Father because, from the viewpoint of position, he is the masculine subject.

In this way, the *Exposition of the Divine Principle* defines God as our Heavenly Father.

2. *Unification Thought* also discusses the attributes of God in its first section, 'Theory of the Original Image'. This is because *Unification Thought* is God's philosophical thought. Centering on the Unification Principle, *Unification Thought* reorganizes and sets right existing philosophical systems in accordance with the teachings of the True Parent. Although *Unification Thought* explains God as the Original Image, it does not reveal His nature as the Original Root Substance.

3. OSDP describes God as having two kinds of attributes:

The first is Divine Image (primary attributes, direct attributes)

The Second is Divine Nature (secondary attributes, indirect attributes)

- In addition to Divine Nature, God's attributes include the Divine Image, which is a more critical and important attribute.
 - Of God's attributes, Divine Image refers to the shape or state part of His attributes. Although we cannot see God with our eyes, God has both a shape aspect and also an aspect of elements (material, substance) which are able to express that shape. (Romans 1:20, Genesis 1:27)
 - In addition to this shape aspect, God also has aspects of function, character and ability. We refer to these aspects as God's Divine Nature.
4. *Exposition of the Divine Principle* is the highest form of theological text in the history of religion. *Unification Thought*, which reorganizes and sets to right existing philosophies and ideologies centering on the Unification Principle revealed by True Father, is the highest form of philosophical text. *Wolli Boncheron* (OSDP) brings together and organizes the contents of these two texts.

For this reason, the True Parent declared that with the proclamation and teaching of OSDP, the mission of religion has concluded and the history of ideological conflicts is now finished.

As God's Providence has progressed, the Unification Principle has been explained through *Wolli Haeseol*, *Wolli Kangnon* and OSDP.

Wolli Haeseol (Commentary on the Principle) is a commentary that explains the *Wolli Wonbon*, discovered and revealed by Rev. Sun Myung Moon in both the physical and spiritual realms after he fought and defeated myriads of satanic beings. *Wolli Haeseol* is the formation-stage or 'symbolic' Principle.

Wolli Kangnon (Exposition of Divine Principle) is an exposition that arranges the contents of *Wolli Haeseol* to make them easier and more suitable for lecturing. This is the growth stage or 'image' Principle.

Wolli Boncheron (Theory of the Original Substance of Principle) is the Principle that clearly reveals God as the Original Substance. *Wolli Boncheron* is the completion stage or 'substantial' Principle. It penetrates deeply to reveal the world of God's heart and the nature of the cosmos. It is the principle that will allow us to solve the problems of the world and realize Cheon Il Guk, which is God's ideal of creation.

Wolli Boncheron (OSDP) is the standard that holds the key to fundamental solutions to all the complex and intractable problems in the real world, problems that arose because of the Fall of Adam and Eve, the ancestors of humankind. These problems include all the problems in the world, such as individual problems, family problems, social problems, national problems, ideological problems, religious problems, sex-related problems (problems of immorality), political and economic problems, education and art-related problems, environmental and pollution problems, problems of international borders and problems related to spiritual phenomena.

The solutions to these problems only become available when the attributes of God, namely the Divine Image and the Divine Nature, are precisely and accurately identified.

(II) How Does God Exist?

- Exodus 3:14 God is **self-existent**. **Spirit** (John 4:24), **Love** (1 John 4:8)
- Romans 1:20 God's power and deity are perceived in the things that have been made.
- Genesis 1:27 Created man in His own image; male and female created He them.

1. Laws of existence

{ Law of cause and effect
{ Law of resemblance

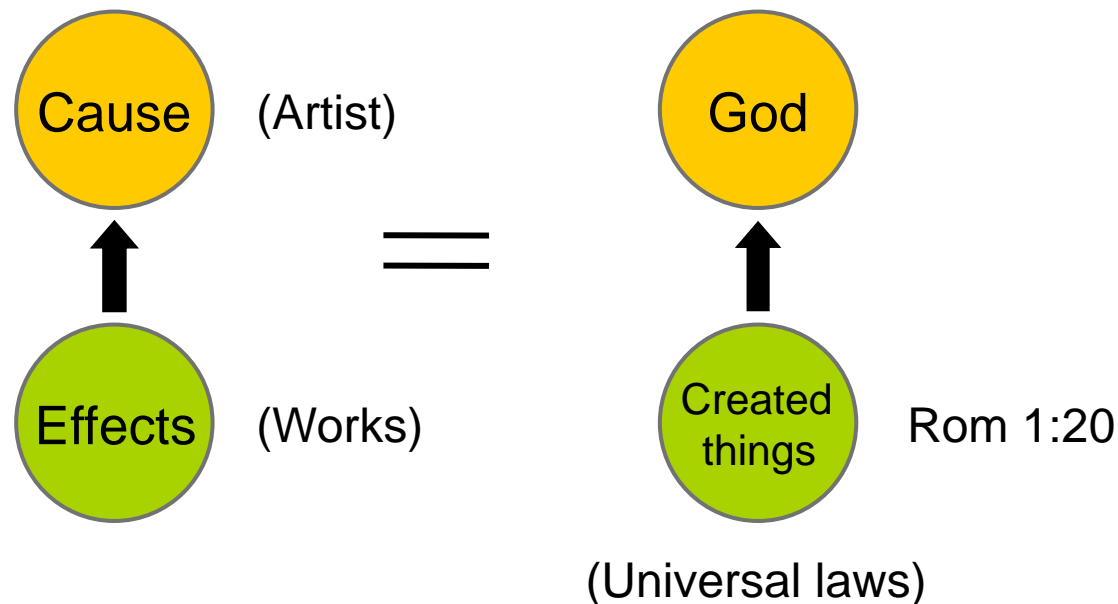

2. God's Dual Characteristics

Original Substance

Harmonious Unified Body of Dual Characteristics of SS/HS
 Harmonious Unified Body of Dual Characteristics of Yang/Yin

GOD: First Cause

(Creator, Absolute Being, Unique One)

From the viewpoint of position
 = Masculine Subject : **FATHER**

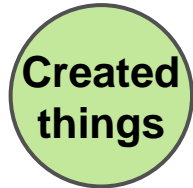

Rom1:20
 (Universal Laws)

Shimjung
 True Love (Character)
 Infinite Spirit (Divinity)

Attribute

Universal Prime Force
 Principle. Law. Order
 Infinite Energy
 (Ability)

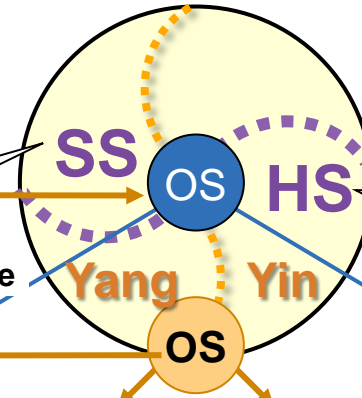

Sung Sang

Yang Nature Yin Nature

Hyung Sang

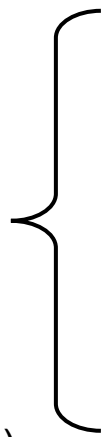

	Mind	Male	Female	Body
Man	Mind	Male	Female	Body
Animals	Mind	Male	Female	Body
Plants	Mind	Stamen	Pistol	Body
Molecules	Inner Directive	Positive ion	Negative ion	Matter (Atoms)
Atoms	Inner Directive	Nucleus	Electron	Matter (Particles)
Particles	Inner Directive	Yang type nature	Yin type nature	Energy
Relationship	Subject, Internal Cause, Vertical Incorporeal	Subject Internal Right	Object External Left	Object, External Result, Horizontal Corporeal

The Relationship of God's Original Sung Sang and Original Hyung Sang
 ⇒ Completely Equal Elements (Unified Body)

Water, Vapor and Ice = H₂O ⇒ Dual Characteristics Theory = Theory of Unique Oneness

3. The Attributes of God

God's attributes are Divine Image and Divine Nature.

Divine Image is God's primary attribute (direct attribute) and **Divine Nature** is God's secondary attribute (indirect attribute).

1) Divine Image

{	Universal Image	{	Dual characteristics of Original SS and Original HS (direct attributes) primary attributes
	Individual Image	{	Dual characteristics of Orig. Yang Nature and Orig. Yin Nature (indirect attributes) secondary attributes Individualization of the universal image (individual truth body)

(1) Dual Characteristics of Original Sungsang (SS) and Original Hyungsang (HS)

i. Original SS (Internal Character) and Original HS (External Form) (Primary Attribute)

Original SS	{	Corresponds to God's mind (shimjung, true love, personality) Root cause of all incorporeal, functional elements in the creation
Original HS	{	Corresponds to God's body (principle, law, order) Root cause of all corporeal, physical elements in the creation Raw material (material, substance) for the creation of the universe Possesses unlimited potential (ability to be molded) to express the forms of all created beings

ii. Internal Structure of Original Sungsang and Original Hyungsang

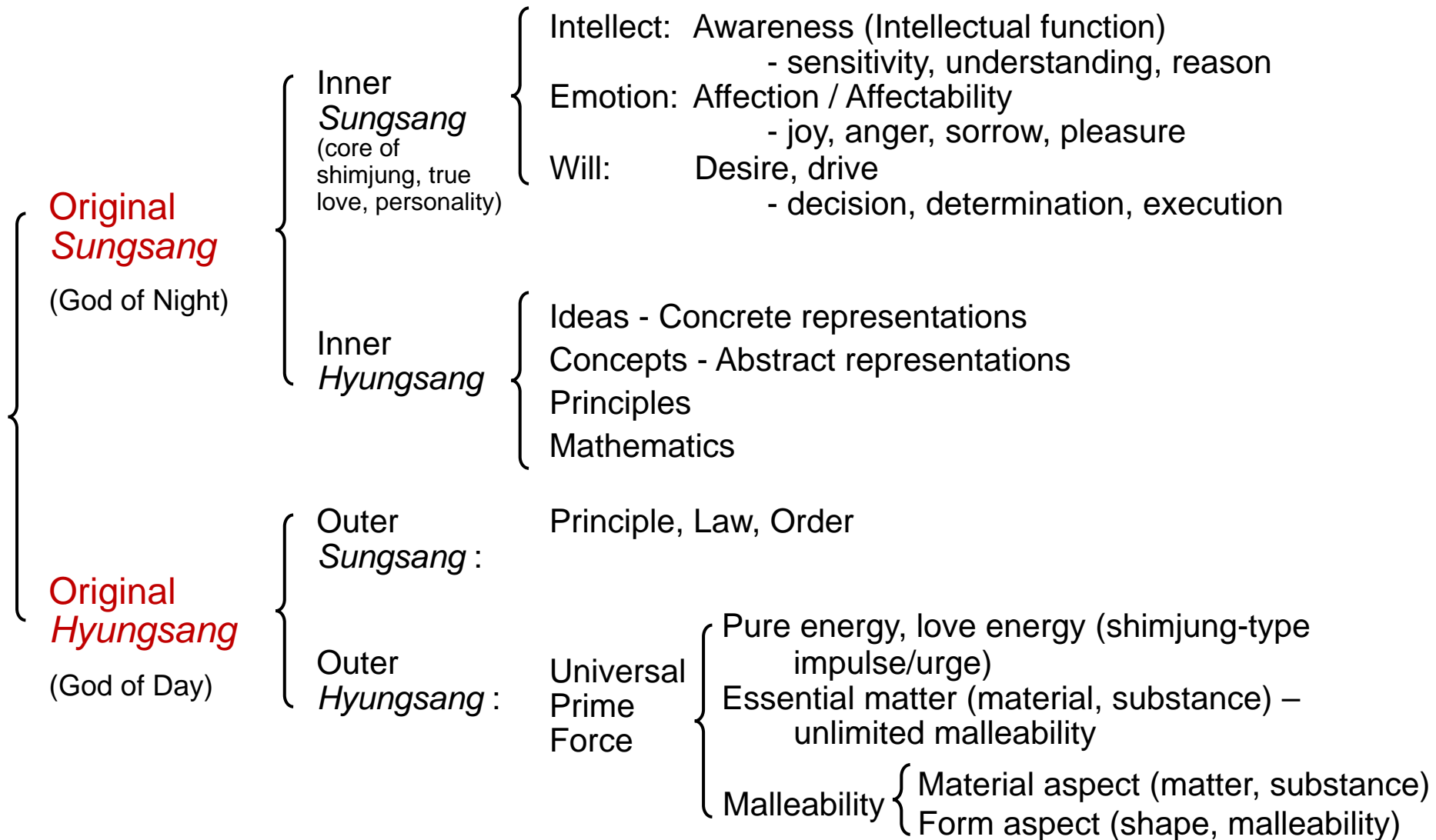

iii. Dual Characteristics of Original Sungsang and Original Hyungsang

God (Divine Image) is the harmonious subject partner and harmonious unified body of the dual characteristics of Original Internal Nature (SS) and Original External Form (HS).

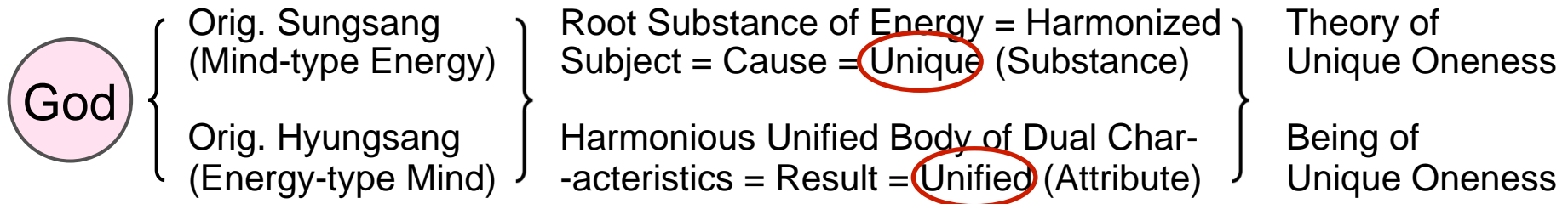

a. Unified Body of Original Sungsang and Original Hyungsang

The Divine Image (God) is the unified body of Original Internal Nature and Original External Form. Why? Because Original Internal Nature (OSS) and Original External Form (OHS) are homogenous in nature. If OSS and OHS were heterogeneous, they could not form a unified body.

Example: The phenomena of water, ice and steam appear as liquid, solid and gas, but in essence they are the homogeneous H²O. In contrast, water and oil are both liquids, but they do not become one. Why? Because water and oil are heterogeneous.

Homogenous OSS · OHS = Monism (Unique Being of Oneness = Hananim)
 Heterogeneous OSS · OHS = Dualism (conflict, confrontation and struggle)

Sungsang and Hyungsang, which manifest as the result of original sungsang and original hyungsang, appear to be heterogeneous (formless – with form, spirit - material, mind - body), but because the essence of the original substance is homogenous, they are in fact unified, and are not expressions of dualism but rather are an expression of 'unique one-ism', or unificationism.

● **The Original Root Substance of the Principle is a Unified body.**

Relationship b/n OSS, OHS ➡ Completely Identical : Equal Elements (Unified Body)
 Water, Steam, Ice = H₂O ➡ Theory of Dual Characteristics (Unified Body) ➡ **Unique Oneness**

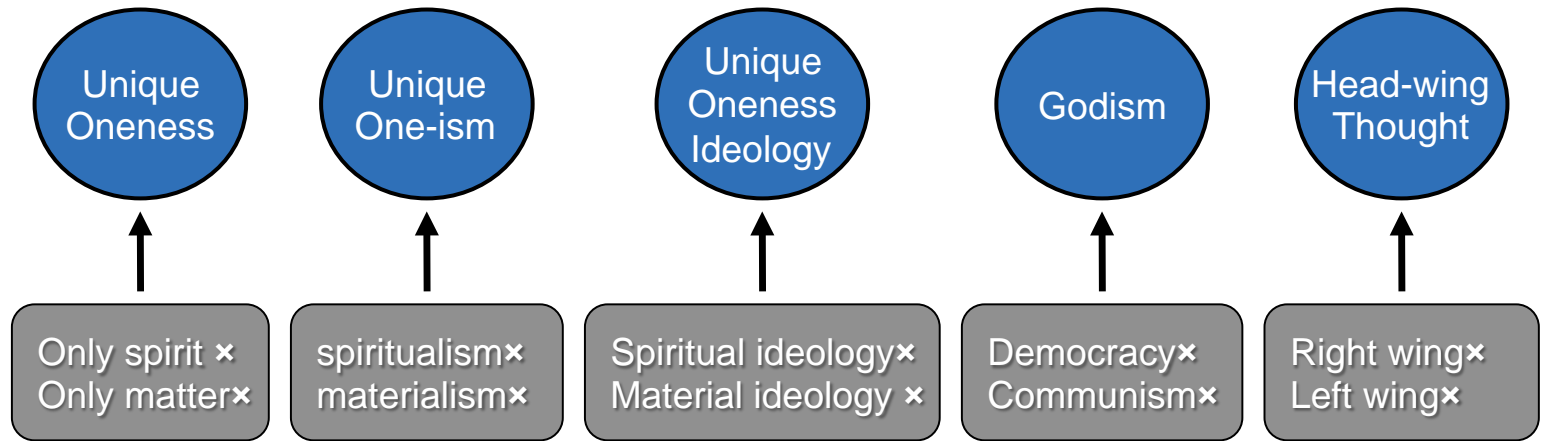

● **Headwing Thought**

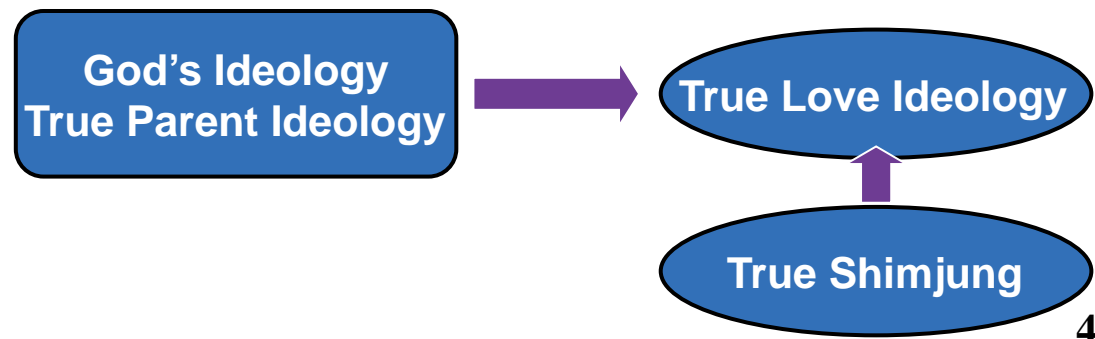

The arguments for dualism in existing philosophies arise from an ignorance of the homogeneous nature of *sungsang* and *hyungsang* (internal nature and external form). If *sungsang* and *hyungsang*, which are attributes of the original substance, are seen as heterogeneous rather than homogenous, this results in a dualism that gives rise to conflict, confrontation and struggle. If this were the reality, there would be no way to solve the problems of the world, and God's ideal of creation, namely an ideal world of peace, unity and happiness, could not be realized.

Thus, the original root substance of the principle is the absolute unique being of oneness, the one being, Hananim. That being, God, is the absolute subject being.

[Conclusion] God is the harmonious subject of the dual characteristics of original *sungsang* and original *hyungsang*, and He exists as a harmonious unified body.

b. The original substance from the perspective of OSDP (Theory of Original Substance of Principle)

From the viewpoint of **CAUSE** : The original substance is Hananim, the **unique being of oneness** who is the harmonized subject and who exists as the original energetic substance.

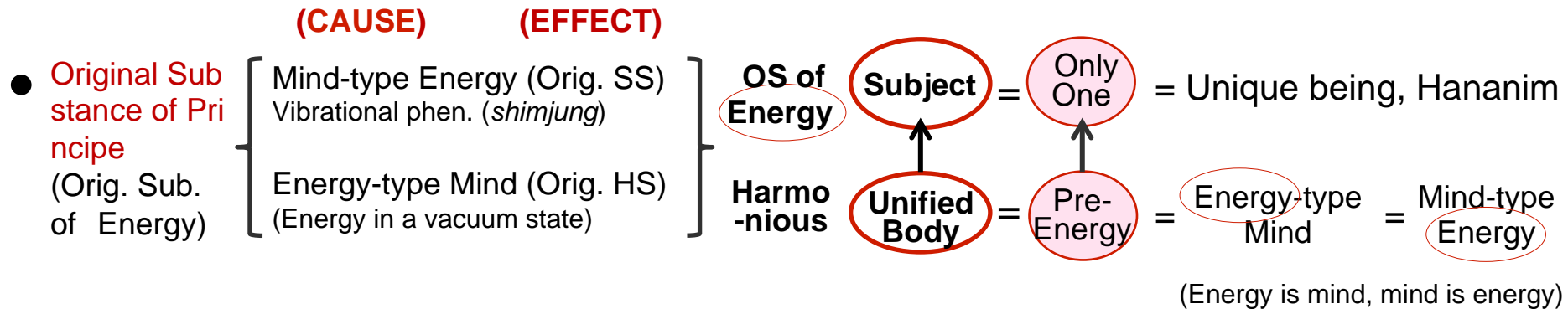

● **Basis of matter** → Aim of scientific research

Modern science reveals basis of matter is energy.

God's HS is the energy that exists prior to the energy that forms matter, and can therefore be called pre-energy.

● **Pre-energy** { SS-type mind-type energy & HS-type energy-type mind } Refers to the unique unified body that exists as the harmonious subject

From the viewpoint of **EFFECT** : The original substance is Hananim, the unique being of oneness who exists as the harmonious unified body of the dual characteristics of Original SS & Original HS

c. Sungsang & Hyungsang from the viewpoint of OSDP (Theory of Original Substance of Principle)

Hananim is a unique, eternal and unchanging being existing from before the generation of the universe.

What caused God to come into being? God came into being due to love.

How was the basis of the universe realized? There was a seed of love, and this absorbed its counterpart, with the result that Hananim himself came to consist of sungsang and hyungsang.

This took place centering on what? God was formed centering on love.

It's just the same as each of you. The seed of life received by each of you due to the love between your mother and father.

Just as one cell grew and then became you; God himself grew in the same way. For God himself, his eyes formed, his nose formed; this is how he formed. It's exactly the same.

How did God come into being? God began as a cell of love and then grew, such that God came into being. It's just the same as each of you.

(CSS 207-27 (CSG (K) p. 1526)

- **The basis of the universe began from love.**

How did God come into being? Love is the center. (CSS 198-237)

- **What is the basic foundation of the universe?**

What did the universe begin from? It began from love.

Scientists say that the universe is comprised of energy, force.

They observe action, and that's how they recognize energy.

(CSS 247-119)

- **Why does God exist?**

For what reason does God seek to exist?

God seeks to exist because of love.

Therefore, God needs a partner of love.

In this way, the omniscient, omnipotent Hananim had no choice but to create his partner of love. (CSS 208-231)

- **What do you think the center of love is?**

The center of love would be what we call 'God'. Hananim is the unique, eternal and unchanging being existing from before the generation of the universe. OK then, so love is the flow of shimjung, heart. When the internal shimjung flows outwards, this is love. Accordingly, the essence of Hananim is *shimjung*.

So then, how was it possible for God to create the universe and human beings? It was possible because God possesses shimjung. It was possible because life can only appear from the place where shimjung is present, and in the place where life is present, developmental action (creation) takes place.

But then, within that creation, there must be a purpose, and the reason why this is so is because that which we call shimjung is originally a thing that is directed towards a purpose. That purpose is joy. **CSS 65-258 (CSG p.1527)**

Conclusion

God, who is the original root substance of the Principle, and who exists as original root substance of energy, is the harmonized subject and is the unique being of oneness (Yu-il ja), Hananim. In addition, God exists as the harmonious unified substance of original *sungsang* and original *hyungsang*, and is the Hananim of shimjung, true love and personality.

(2) Dual Characteristics of Original Yang Nature and Original Yin Nature

- i. In God's primary attribute, namely the Divine Image, we find the attributes of original sungsang and original hyungsang, plus another set of attributes, namely original yang nature and original yin nature. The dimension of the attributes of original sungsang and original hyungsang is different to the dimension of the attributes of original yang nature and original yin nature.

Original sungsang and original hyungsang are God's primary attributes (direct attributes), and original yang nature and original yin nature are God's secondary attributes (indirect attributes).

Original sungsang and original hyungsang are God's direct attributes, and because original yang nature and original yin nature exist as attributes of original sungsang and original hyungsang, they are God's indirect attributes.

ii. **Original yang nature and original yin nature are attributes of the original sungsang and original hyungsang.**

Because an attribute is something that belongs to a substance, a substantial body, attributes cannot appear with some substantial body or substance.

[E.g.] When we say that a flower is beautiful, it is only because the substance we call a flower exists that we can say 'it is beautiful'. In this case, the flower is the substance, and 'it is beautiful' is the attribute.

- God's attributes include the primary attributes of original sungsang and original hyungsang. In this case, God is the substance, the substantial body, and sungsang (mind) and hyungsang (body) are attributes.
- God's secondary attributes, that is, original yang nature and original yin nature, are attributes of original sungsang and original hyungsang, which are God's primary attributes.

In this case, original sungsang (mind) and original hyungsang (body) are the substance, and original yang nature and original yin nature are the attributes.

Accordingly, the original root substance of the Principle is the harmonized subject of the dual characteristics of original sungsang and original hyungsang, and is the absolute unique being of oneness, the one being Hananim, who exists as the harmonized unified body.

iii. Original sungsang and original hyungsang both have attributes of original yang nature and original yin nature.

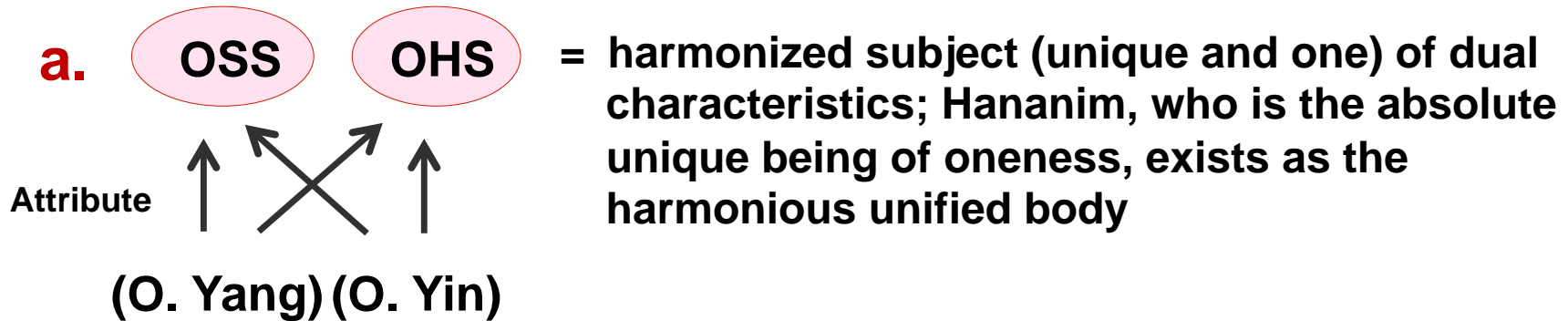

[Example]

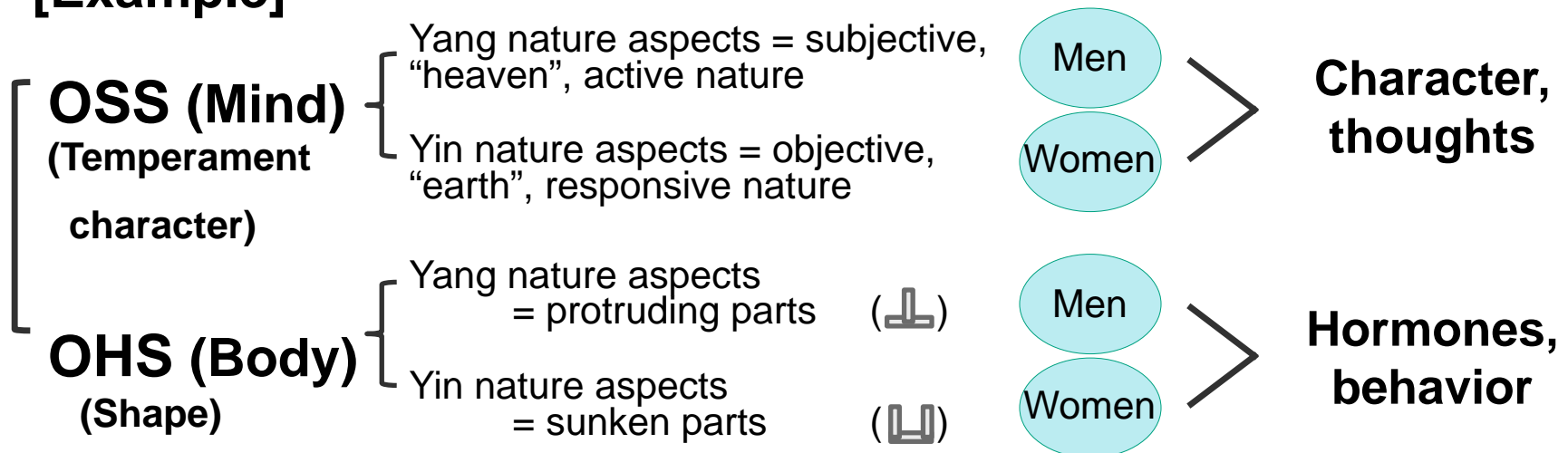

C. When we view God, who is the harmonious unified body of the dual characteristics of original yang nature and original yin nature, in terms of positional role, God is the masculine subject. Accordingly, we call God, who is the original substance of the Principle, Father.

This is why when we address God, we address him as 'Heavenly Father', or '(our) Father in Heaven'.

- In the **Old Testament era**, God was called 'the God Jehovah'.
- In the **New Testament era**, Jesus called God 'Father', and referred to himself as the son of God. This expression is the core and essence of the Gospels.
- In the **Completed Testament era**, God is called 'Father' or 'Father in Heaven' by the True Parent.

When the substantial True Parent completes his portion of responsibility to achieve complete perfection, God, who is the incorporeal True Father, will manifest as the substantial True Parent through the substantial True Parent. Accordingly, in the Completed Testament era, **the essence and core of the Gospel is 'the True Parent'**.

Here, 'True Parent' refers to True Father.

The official name of Rev. Moon is '**the True Parent**'. This is the name given to him by God. (**CSS 280-77, 1996.11.1**)

iv. The relationship b/n original SS and original HS and the relationship b/n original yang nature and original yin nature

- a. Relationship b/n original sungsang and original hyungsang
'subject - object', 'internal - external', 'cause - effect', 'vertical - horizontal', 'incorporeal - corporeal'
- b. Relationship b/n original yang nature and original yin nature
'subject - object', 'internal - external', 'right - left'

v. The relationship b/n original SS - original HS and original yang nature / original yin nature

- a. Original yang nature / original yin nature are attributes of original sungsang / original hyungsang.

That is, original sungsang possesses the attributes of original yang nature and original yin nature, and original hyungsang also possesses the attributes of original yang nature and original yin nature.

Example

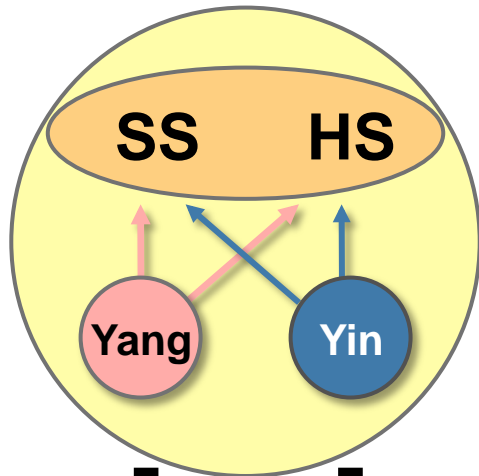

Male (Man) Female (Woman)



Main Nature



Attribute



Substantiation



Shimjung · True Love · True Personality

Principle · Law · Order
· Universal Prime Force

Original Root Substance of Absolute Sex

(Absolute Sex, Absolute Purity)

(Absolute Sex, Absolute Purity, Absolute Fidelity)

Sex-related problems (immorality)

- [Mind, Body
- [Yang, Yin
- [Body Shape
- [Hormones

- [Mind, Body
- [Yang, Yin
- [Body Shape
- [Hormones

b. Harmonizing quality of yang nature and yin nature

Because original yang nature and original yin nature are included within original sungsang / original hyungsang as attributes, sungsang and hyungsang achieve harmony when they are expressed.

Thus, Hananim is the harmonized subject and unified body of the dual characteristics of original sungsang and original hyungsang.

Moreover, men and women, who are the substantiation of original yang nature and original yin nature, also have the attributes of yang nature and yin nature.

The reason for this is so that original sungsang and original hyungsang can achieve harmony, and so that original yang nature and original yin nature can also become harmonized bodies that achieve harmony.

Accordingly, all beings express beauty and harmony centering on love.

c. The yang and yin discussed in Eastern philosophy is different to yang and yin presented by OSDP.

In Eastern philosophy, yang and yin refer to men and women directly.

From the viewpoint of OSDP (Wolli Boncheron) however, men and women are substantial manifestations of sungsang and hyungsang, which have yang nature and yin nature as attributes.

vi. The original root substance of the principle is an absolute single being.

God, who is the original root source of the principle, is the absolute unique being of oneness who exists as the original substance of energy. As the subject being in which the dual characteristics of original sungsang and original hyungsang are harmonized, God exists as a unified body.

In addition, because God exists as the unified body harmonizing the dual characteristics of original yang nature and original yin nature, which are attributes of his original sungsang and original hyungsang, when we view God from the perspective of position, God is the masculine subject and we call God our Father.

Accordingly, the unique being of oneness who is the origin and source of the principle is one person and one person alone. He is the one being, the one we address as Heavenly Father.

If we conceived of the sungsang and hyungsang of the principle root substance as being heterogeneous instead of being homogeneous, the result would be dualism, and the source of conflict, confrontation and struggle.

If we took this approach, the problems of the real world could not be solved, and the ideal world of peace, unity and happiness, namely God's ideal of creation, would not be realized.

Accordingly, the original root body of the principle is one person, namely the absolute unique being of oneness.

That one being, Hananim, exists as our subject, and is the true father, or Heavenly Father.

a. **Gen 1:27** says that 'God created man in his image; male and female he created them.'

We can see some people who assert that because there is **God the Heavenly Father, there must** also be a **Heavenly Mother**, and that in terms of the **Messiah**, there must also be a **Mother Messiah**. Also, because there is the **only begotten son** there must also be the **only begotten daughter**.

If, as these people assert, the original substance is two, not one, then this gives rise to a big problem.

Why? Because if the original substance is two, then we can have no peace and unity but instead have conflict and confrontation - struggle. If we say the original substance is the source of conflict and confrontation - struggle, the problems of the real world cannot be solved and God's ideal of creation, namely Cheon Il Guk, cannot be realized.

Therefore, True Father taught us that the original substance of the principle is absolutely a single, unique being, one person.

Moreover, in the *wolli wonbon* ("Original Manuscript of the Principle"), Father records that the creation of the universe starts with 'one' and proceeds to the 'whole'. When we count **numbers** we count beginning from 'one', not from 'two'.

Accordingly, Hananim, who is the original root substance of principle, is the True Father, who is absolute, unique, unchanging and eternal. From the viewpoint of OSDP (theory of the original substance of principle), using the expression 'Heavenly Parent' to address or refer to God is not correct. ⁶³

- b. Moreover, asserting 'gender equality' of men and women centering on sex (gender) is also incorrect.

Why? The equality of men and women is not found in equality centered on gender, but is found in equality in love, equality in character, and equality in joy and satisfaction.

Apart from this, there can be no actual equality between men and women.

If one asserts gender equality centering on gender or sex, then there is no way to resolve sexual problems, which are the most critical problems in the real world. There will be no end to free sex, and it will be impossible to realize the ideal of true families, which place the utmost priority on absolute sex purity. This ideal of true families is the most critical element for the realization of God's ideal of creation. Accordingly, the idea of gender equality is not part of the principle, which is God's ideal of creation. It is in fact a false theory and a false ideology.

Anyone who asserts gender equality does so from ignorance of the principle and an incorrect and inaccurate understanding of God, the original substance of principle.

C. God is the True Father, but internally he is also the True Parent.

As explained above, men and women were created in resemblance of God's (the Father) *hyungsang*.

Therefore, masculinity and femininity are attributes of Heavenly Father (*hananim aboji*).

Adam and Eve are created as God's son and daughter, as the substantial divided body of the two sexes which are part of Heavenly Father's *hyungsang*.

If and when Adam and Eve grow and complete the children's heart, sibling's heart, couple's heart and parent's heart (4 great realms of heart) from the position of God's son and daughters, they become the substantial True Parents. At that time, God, the original root substance of principle, becomes the substantial True Parent through Adam and Eve who have become True Parents.

d. In this manner, as Adam and Eve complete their portion of responsibility during the growing period and become the substantial True Parents, they make it possible for the incorporeal Heavenly Father to become the substantial True Parent.

At this time, Adam and Eve resemble the perfect complete God and become the substantial temple attending God, achieving one mind; one body; one idea; one harmony; thereby becoming the true ancestors of humankind.

However, Eve made a mistake and Adam failed to fulfill his portion of responsibility. By falling, they could not become the substantial temple attending God and instead became the false parents of humankind.

In order to accomplish his absolute will, God sent Jesus the Messiah as the 2nd Adam, but because the leaders of the Jewish faith and the Israelite people had no faith, Jesus was forced to go the way of the crucifixion, leaving behind only his promise to return again.

As a result, Jesus was unable to rise from the position of only begotten son to the position of the parent. He was unable to become the True Parent, and unable to become the true ancestor of humankind.

- e. Because the returning lord comes as God's son, we call him the True Father, but internally he has the name of True Parent.

According to True Father, "the official name of Rev. Moon is 'the True Parent'. This is the name given to him by God." (CSS 280-77, 96.11.1)

True Father comes from heaven as the True Parent. To become the substantial True Parent, True Father selects one woman from the fallen world, conducts a heavenly ceremony where her original sin is liquidated by the Messiah True Father, and then carries out the Holy Marriage ceremony.

He raises (that is, recreates) that woman to become the True Mother in the position of substantial object to the True Father, so that she can achieve, completely and perfectly, 'one mind, one body, one idea, one harmony' with True Father, and then, centering on True Father, together with him become the substantial True Parents, thereby allowing the incorporeal Heavenly Father to become the substantial True Parent.

Then, he must firmly establish the True Parent of Heaven, Earth and Humankind in substance and conduct the coronation ceremony for the liberation of God, the King of Kings, to finally liberate God.

vii. Sons and daughters from the physiological perspective

Heavenly Father possesses the seed of true love that has shimjung, which is the sperm of absolute sex.

Within the seed of true love, which is the Father's sperm, he has two types of seed that can become either a son or a daughter.

- a. Physiologically speaking, the male chromosomes total 47 and the female chromosomes total 48.

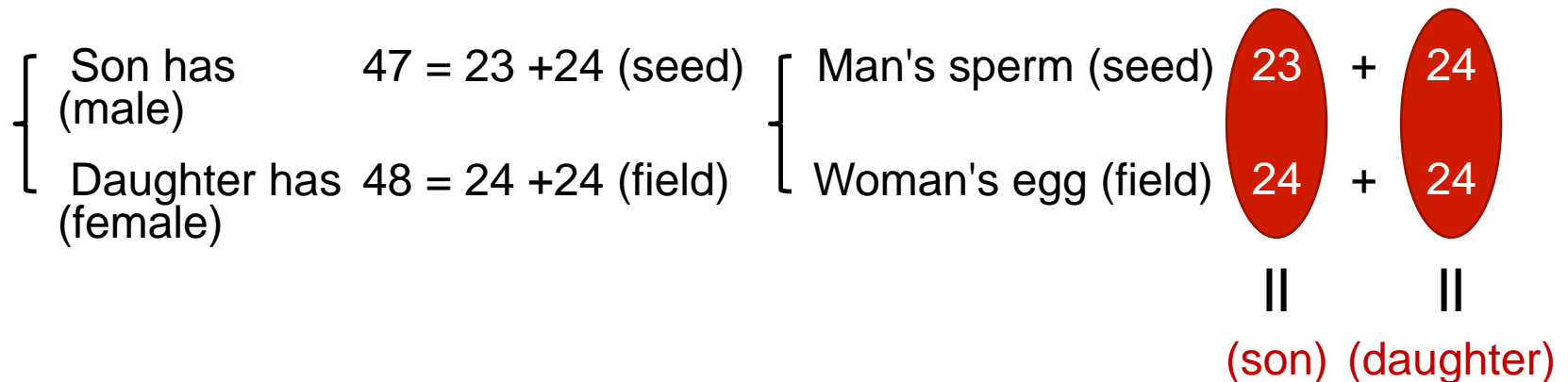

If a male sperm with 23 meets a female egg of 24, the total is 47 and the child becomes a son, but if the male sperm of 24 meets a female egg of 24, the total is 48 and the child becomes a daughter. In this way, from the physiological viewpoint, whether the child is a son or daughter is decided by the male sperm (seed) and is not decided by the female egg.

b. Sperm is the seed and Ovum is the field.

The Seed is eternally unchanging, but the field will change depending on the seed. The Seed is eternal, unchanging and unique.

A pine seed is eternally a pine seed, and does not change into a different seed.

In order for the seed of true love to become fertile, the true love that has God's shimjung must bear fruit and then be planted.

If it does not become the fruit of true love, it will remain infertile even if it is planted. (Selected Speeches 608 p.48, February 18, 2009)

Example

- Chicken eggs include both fertilized and infertile eggs.

The shape of the chicken egg itself is identical. However, an infertile egg will not become a chick, while a fertile egg will.

The fertile eggs include eggs that will become male chickens and eggs that will become female chickens.

- In the case of fruit, when the fruit is ripe, the seed becomes fully mature and the fruit tastes good.

A fully mature seed, if planted, will sprout, but an immature seed will not sprout, even if planted.

viii. Conclusion

The original root substance of principle is the absolute one unique being, the Heavenly Father. When the internal father manifests as the external father, he comes to have the name of 'True Parent'.

(It was more difficult for Heavenly Father to meet the True Parent than it is to catch a specific single fish in all the wide Pacific Ocean.)

True Father explained that his finding the Principle was more difficult than finding a single grain of sand at the bottom of the Pacific Ocean. The Principle was discovered by Father through his fighting with hundreds of millions of satanic forces on earth and in spirit world and gaining victory.

For anyone to change or deny Father's teachings or the Principle which were obtained at such a great price is completely unacceptable.

True Father searched for the Principle in tears and walked the path of restoration in blood.

a. The original substance from the perspective of OSDP

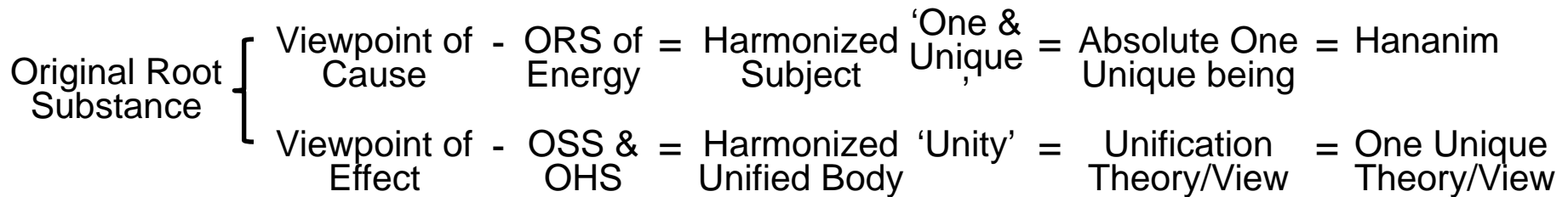

The original substance of the principle, when seen from the perspective of cause, is Hananim, the unique being existing as the original substance of energy. He is the harmonious subject of oneness, and the view of that being is Monism.

However, when seen from the perspective of result, the original substance is the harmonious unified body of the dual characteristics of original sungsang and original hyungsang.

When, as spirit and matter, and as the incorporeal and corporeal, sungsang and hyungsang are viewed from the viewpoint of effect, this can be understood as dualism (traditional philosophical perspective).

However, because the original substance is a unified body, in actuality, OSDP is monism.

Why? Because sungsang and hyungsang are homogeneous, not heterogeneous.

- b. If the original substance of principle, namely sungsang and hyungsang, as expressed through incorporeal and corporeal, spirit and matter, were heterogeneous, this would equal dualism and would result in conflict, confrontation and struggle.

If we take this perspective, God's ideal of creation, namely the ideal world of peace, unity and happiness, would not be realized.

Accordingly, the original root body of the principle is one person, namely the absolute unique being of oneness, Hananim.

- c. In addition, if we assert that because God the original substance is the heavenly father there must also be a heavenly mother, and that because the Messiah is a father there must also be a mother Messiah, then the original substance of principle is two persons, and conflict, confrontation and struggle will continue forever.

- d. Moreover, if we assert 'gender equality' of men and women centering on sex (gender), this also is incorrect.

Why? The equality of men and women is not found in equality centered on gender, but is found in equality in love, equality in character, and equality in joy and satisfaction.

Apart from this, there can be no actual equality between men and women.

If one asserts equality centering on gender or sex, then there is no way to resolve sexual problems, which are the most critical problems in the real world. There will be no end to free sex, and it will be impossible to realize the ideal of true families, which places the utmost priority on absolute sex purity.

Accordingly, the idea of gender equality is not part of the principle; it is in fact a false theory and a false ideology.

Anyone who asserts this kind of gender equality does so from ignorance of the principle and an incorrect and inaccurate understanding of God, the original substance of principle.

(3) Individual Image

- i. Physiologically speaking, because all created beings are created resembling God's dual characteristics, they all possess, in common and universally, sungsang and hyungsang, yang nature and yin nature. Accordingly, sungsang and hyungsang, yang nature and yin nature are what we refer to as the universal image.

While all created beings, including human beings, exist through the universal image, each being also has unique and distinctive properties and characteristics which are personalized expressions of the universal image. These unique characteristics also come from God.

- ii. The characteristics of created beings that exist in God are called the Individual Image.

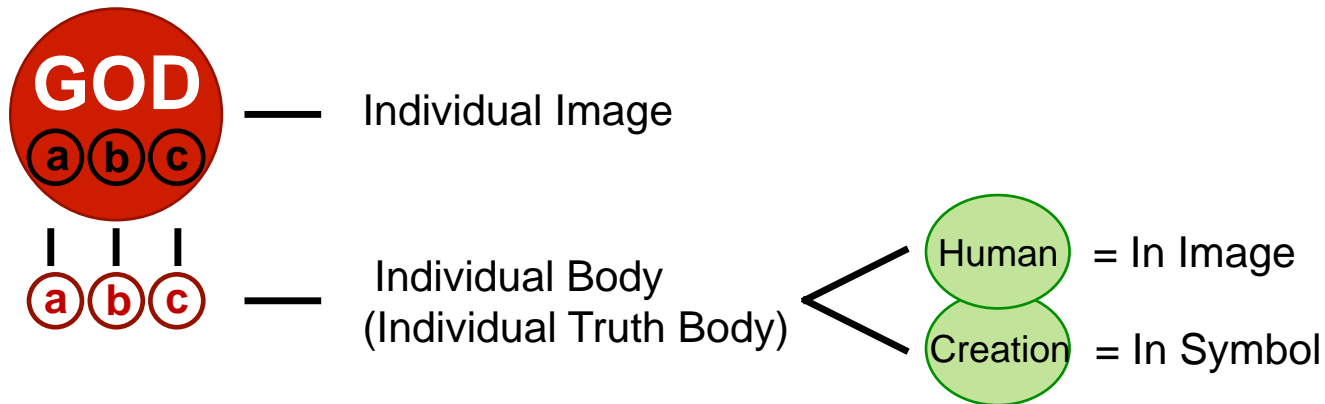

- o Because this individual image is the individualization of the universal image, the sungsang includes individualized features and the hyungsang also includes individualized features.

Features of individualized sungsang → Refers to character, individuality, interests, etc.
Features of individualized hyungsang → each individual's unique physique, constitution, appearance, etc.

iii. Human individuality is the individualization of the original sungsang, and therefore has its origin in the individual image of God.

- For human individuality, character and dignity to be truly respected, we must recognize that the root source of individuality has its origins in God.

The individual image in animals and the individual image in human beings are markedly different.

- Unlike the individual image in human beings, the individual image in animals does not manifest as distinct features for each individual animal, but in most cases, manifests as the characteristics of one species or type.

- This is because each individual human being is created as God's son or daughter, whereas animals are created as objects for human beings to have dominion over.

The same is true in the case of plants as well.

2) Divine Nature

God's divine nature has a number of different attributes, the most important of which are shimjung, logos, creativity, etc. The reason why these are important is because shimjung, logos and creativity provide the absolute standard for fundamental resolution of the problems in the real world.

(1) *Shimjung*
(heart) [The core of God's sungsang (internal character)
God's most essential attribute
The root source of God's true love
The core of God's personality

i. *Shimjung* is the motivation for creation

Shimjung is the irrepressible emotional impulse to experience joy through loving. God's shimjung created the universe as an object of love, an object of joy.

- The center of love is what we call God.

OK then, so love is the flow of shimjung, heart.

When the internal shimjung flows outwards, this is love.

Accordingly, the essence of Hananim is shimjung.

- How was it possible for God to create the universe and human beings?

It was possible because God possesses shimjung.

It was possible because life can only appear from the place where shimjung is present, and in the place where life is present, developmental action (creation) takes place.

- True love is the sense of longing that penetrates to the very marrow of shimjung.

(CSS 65-258) (CSG p. 1527)

ii. *Shimjung* and Intellect, Emotion, Will

Shimjung is the basis of intellect, emotion and will

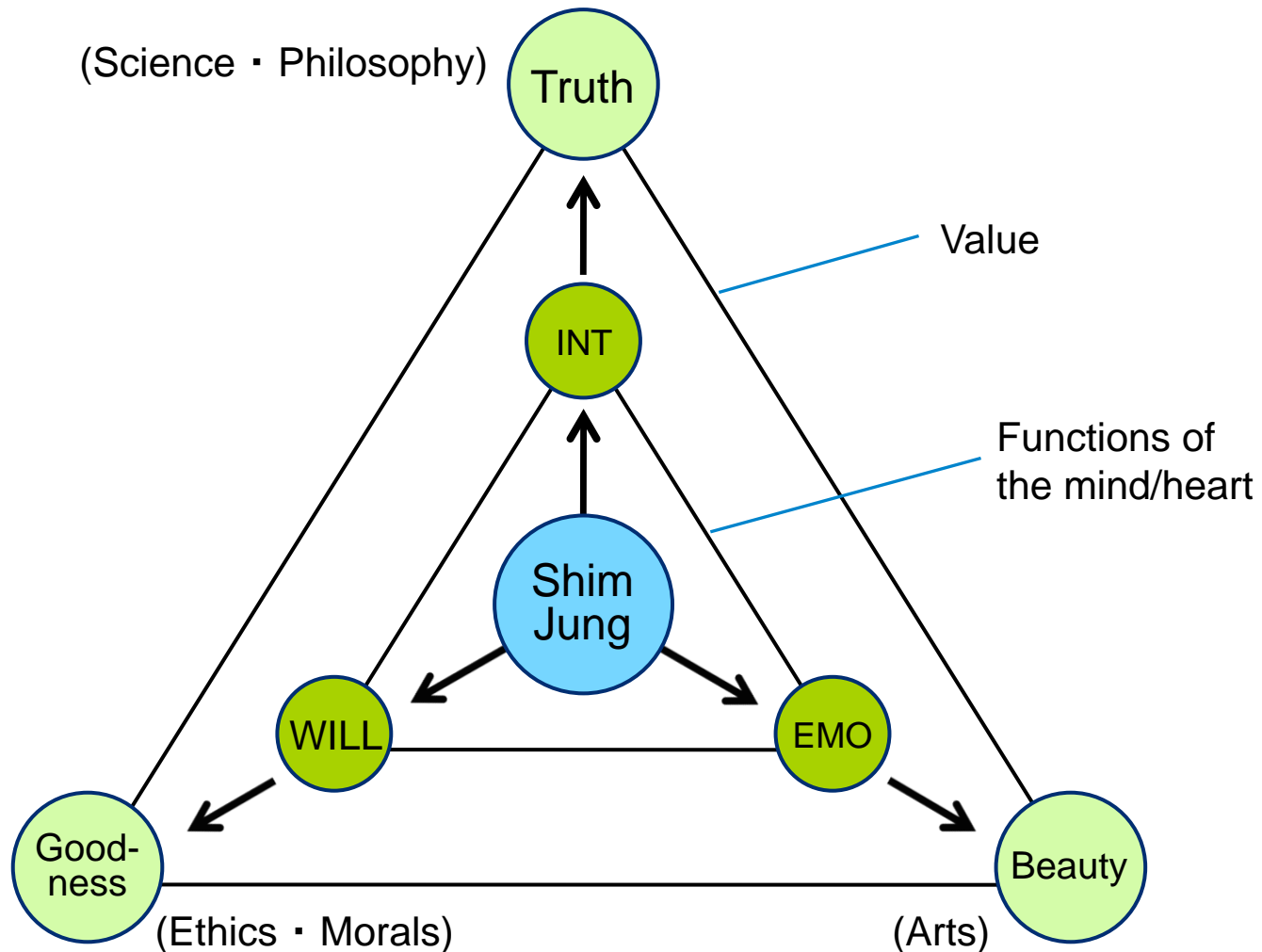

iii. Truth, beauty, goodness, love & clothing, food, shelter and sex

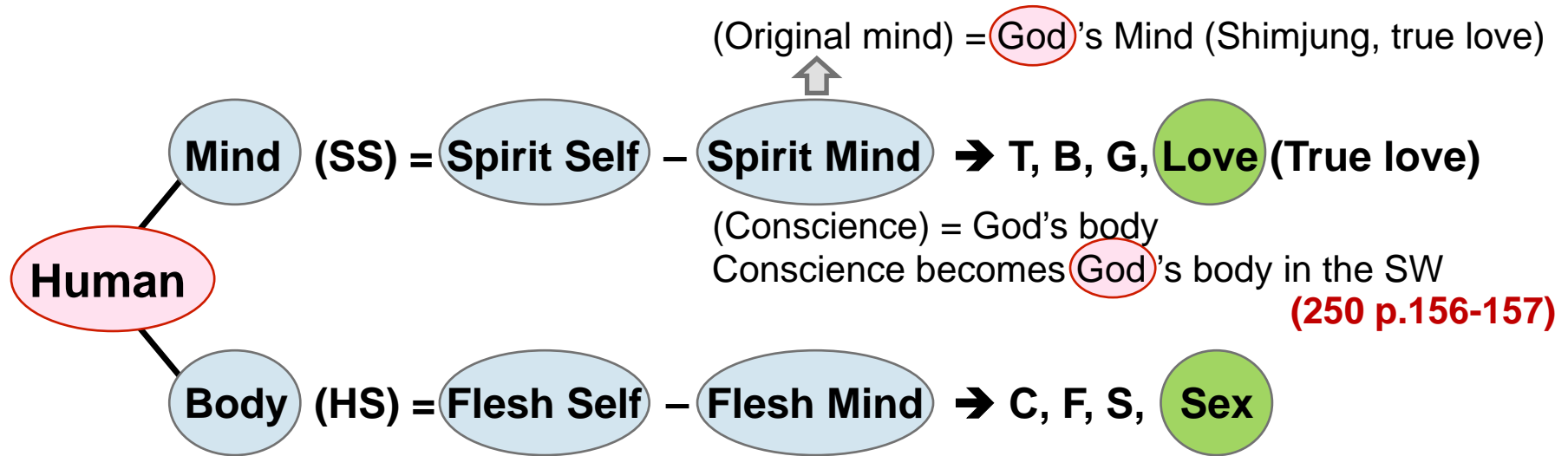

Follow conscience when living in flesh
Checkpoint b/n God & Satan is the conscience

Body (HS) = Flesh Self – Flesh Mind → C, F, S, S

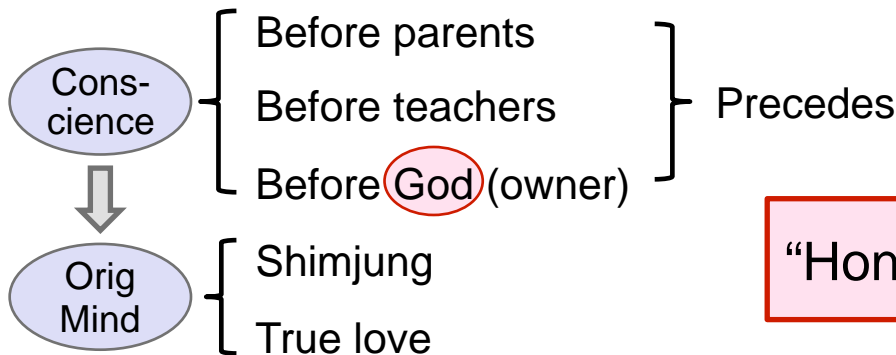

“Honesty is medicine, lies are poison”

(2) Logos

Greek: 'word', "reason-law" - God's thought

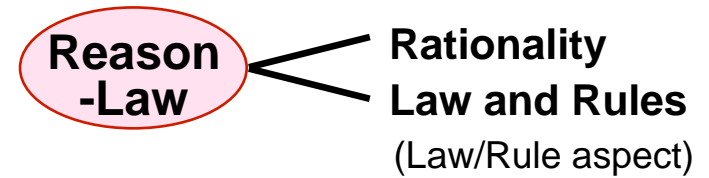
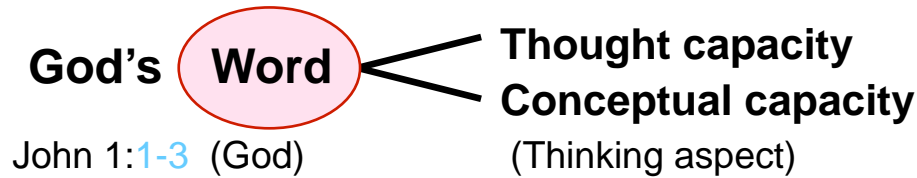

i. Dual characteristics of Logos

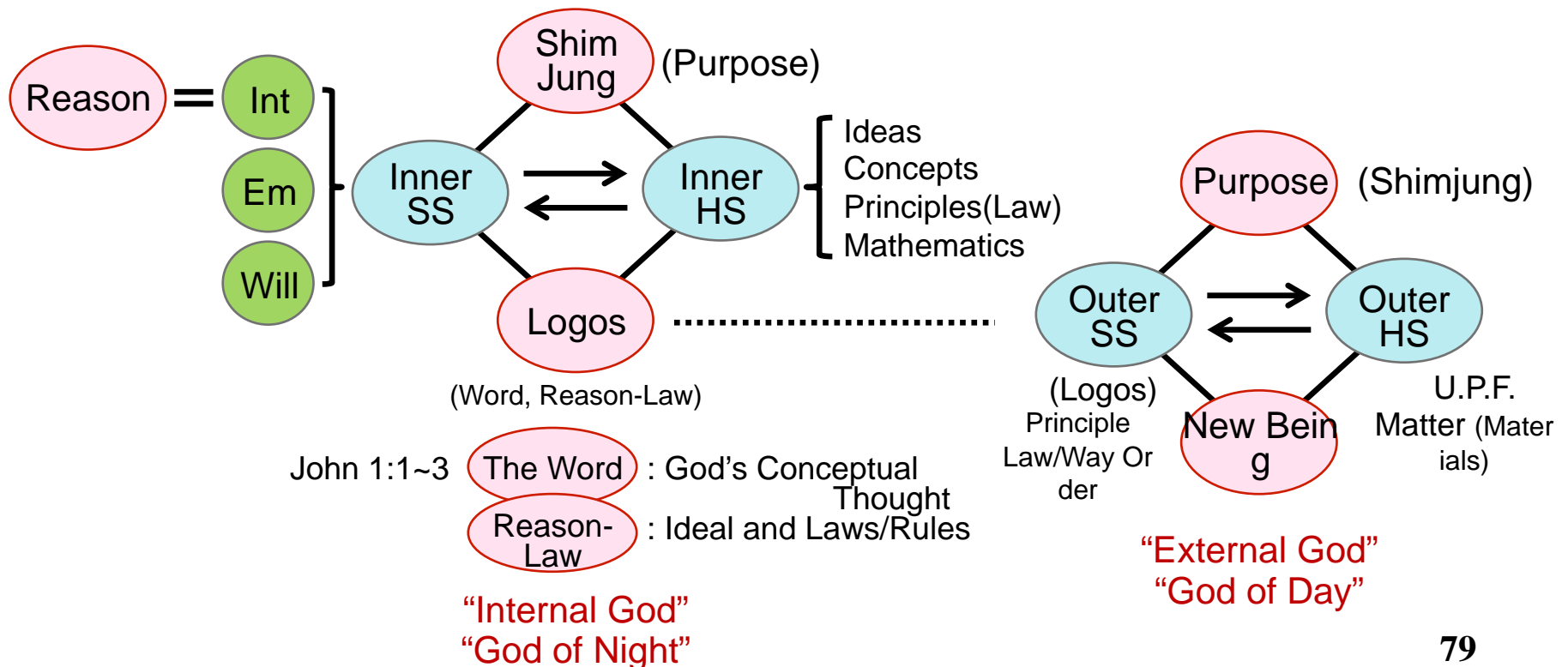

ii. Reason-Law Nature

a. Unification of freedom and necessity

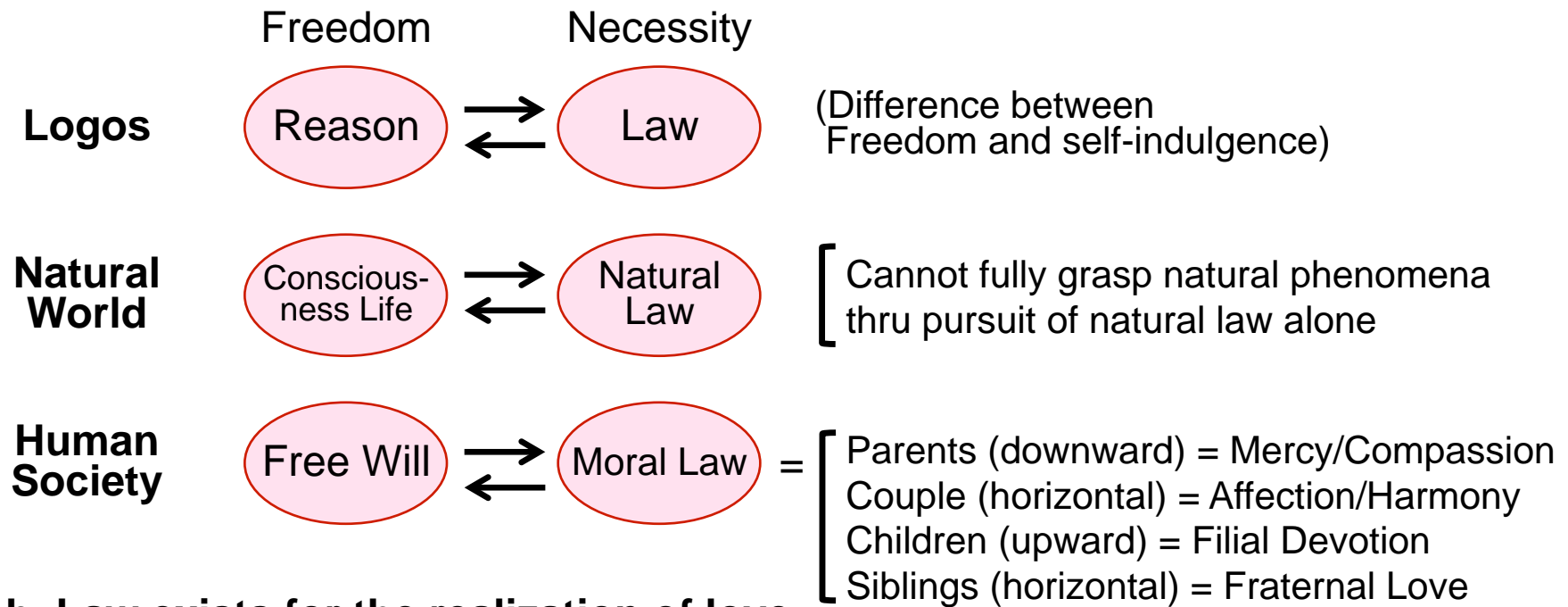

b. Law exists for the realization of love

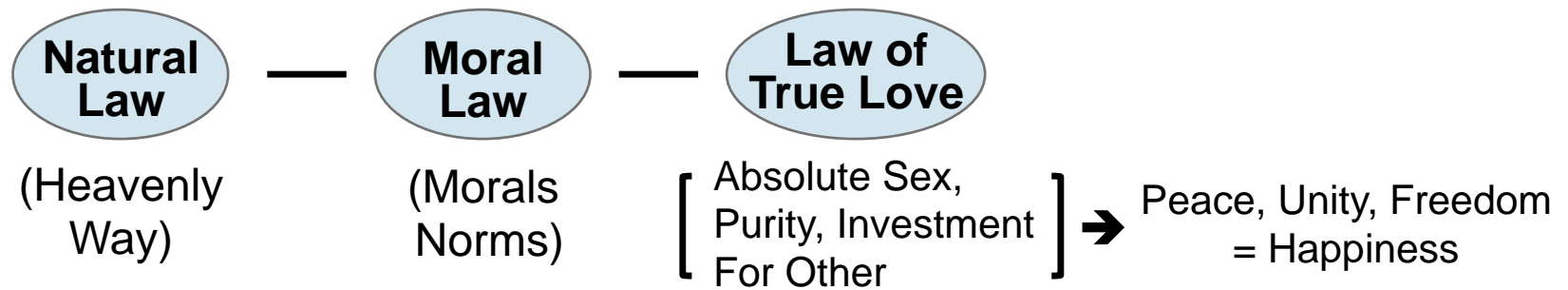

“Blood is thicker than water, True love is thicker than blood.” [Law of Living for Others]

(3) Creativity

i. God's Creative Nature

- God came to possess creativity because God created himself. Thus, God is the first Lord of Creation.
- Ability to form Logos through the give and receive action between inner sungsang and inner hyungsang centering on *shimjung*
- Ability to make all things through the give and receive action between Logos (outer SS) and hyungsang (outer HS) centering on purpose

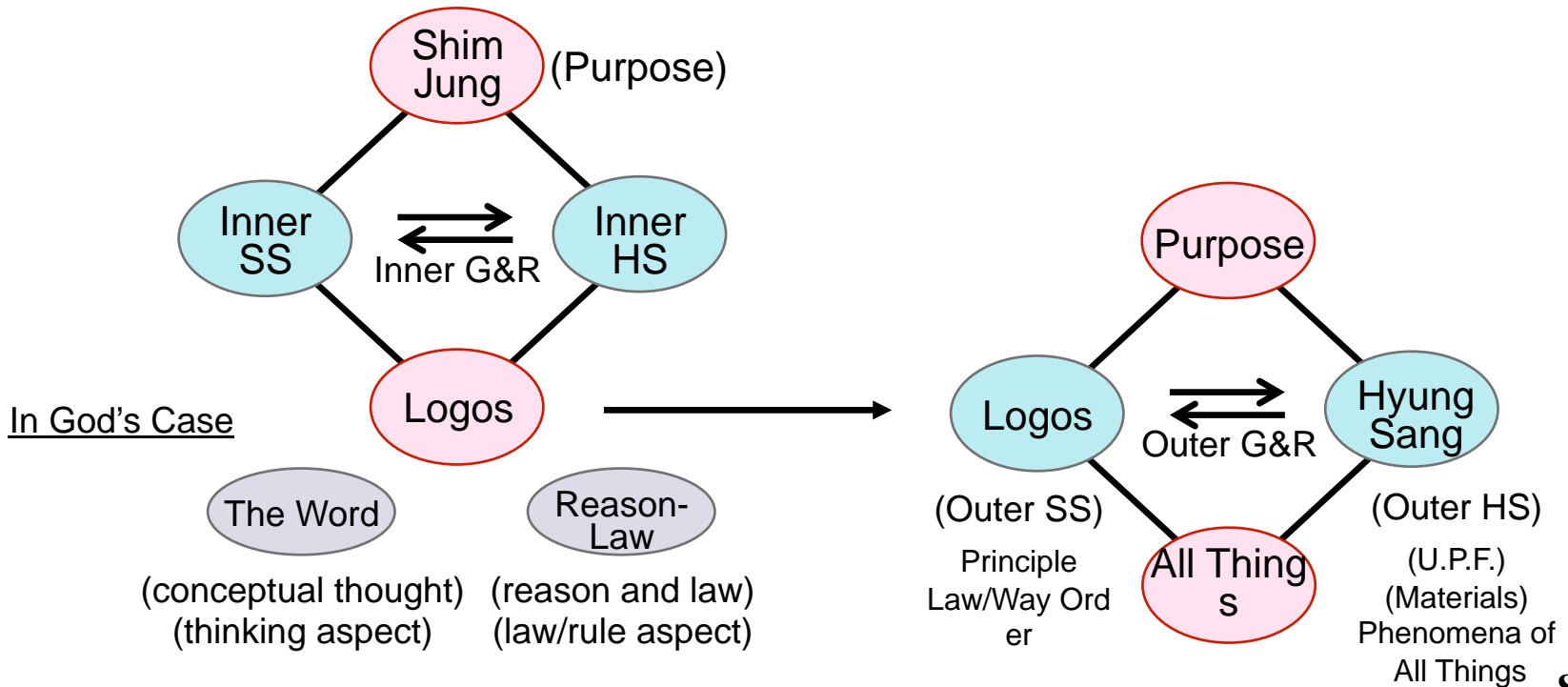

ii. Creative Nature of Human Beings

- a. God came to possess creativity because God created himself. Thus, God is the first Lord of Creation.

Human beings come to have creativity by creating their own character through their own portion of responsibility. This is something even God cannot do for human beings. Accordingly, by believing in and practicing God's word, human beings obtain their own creativity and are thus the second Lords of Creation. In this manner, human beings come to possess the qualification to exist as God's children and have dominion and control over the created world.

Perfection of character = Perfection of true love & shimjung = Perfection of spirit self

Perfection of spirit self = Perfection of spirit mind (conscience) = God's body (Conscience is one with Truth)

Perfection of spirit self = God's mind (Orig. mind is one with God)

Accordingly, life in the physical world is the period for perfect completion of the spirit mind, which becomes God's temple. Perfect completion of the spirit mind comes when living according to the conscience, which is God's body.

True Father explained that when we leave our body and move to the spirit world, our conscience becomes the body of God.

b. Creation by God and creation by human beings

○ In God's case

Centered on Shimjung Inner SS + Inner HS = LOGOS

Centered on Purpose Logos (Outer SS) (Word, RL) + Hyungsang (Outer HS) (U. P. F.) = Creation of **All Things**

Raw material for creation of universe
Phenomena of all things

○ In the case of human beings

Centered on Shimjung Plan (idea) + Material (theme) = Creation of **Works**

○ Creation by God and creation by scientists

[Creation by God = Shim Jung = Purpose of Creation (realize True Love) = 4PF cent. on God = Harmony, world of peace and unity
	Invention by Scientists = Reason = Purpose of Invention (centered on self) = 4PF cent. on Self = Pollution, world of weapons (war, destruction of nature)

Conclusion

Basis of Value must be focused on **God**'s Shimjung (heart).

Standard of Absolute Value = True God (March 1, 1994, TF put **True** in 'Parents Day')

True God, True Parents, True Children, All True Things

4. How did God come to exist?

1) God from the viewpoint of Biblical scripture

The beings in the visible universe are the creation of God (Christianity)

So how did the God who created all things come to exist?

So far, no one has provided an accurate and precise answer to this question. The only two who have explained this in detail is God himself and the son of God, namely the Messiah (the True Parent).

In biblical scripture, it only goes so far as to say God is **spirit**, and **love**. (Exodus 3:14, John 4:24, John 1, 4:8)

2) The Unification Principle revealed by the True Parent

(1) Wollli Kangnon (DP)

God exists through / as dual characteristics.

Dual
Characteristics

Original SS
Original HS = Harmonized subject existing as a harmonious unified body
(The One Unique Being = Hananim)

Original Yang
Original Yin = Harmonious unified body as attributes of sungsang and hyungsang
(Masculine Subject = Father)

(2) Wolli Boncheron (Theory of Original Substance of Principle)

The unified body that is the original substance of the principle is like a single core point.

Core - Core of the Whole. Core of the universe. Core of the Cosmos.

Core - Actual Body (Substance) (Formless substance)

- o The actual core exists while possessing two different aspects.
The core exists with a center and with shimjung (true love).

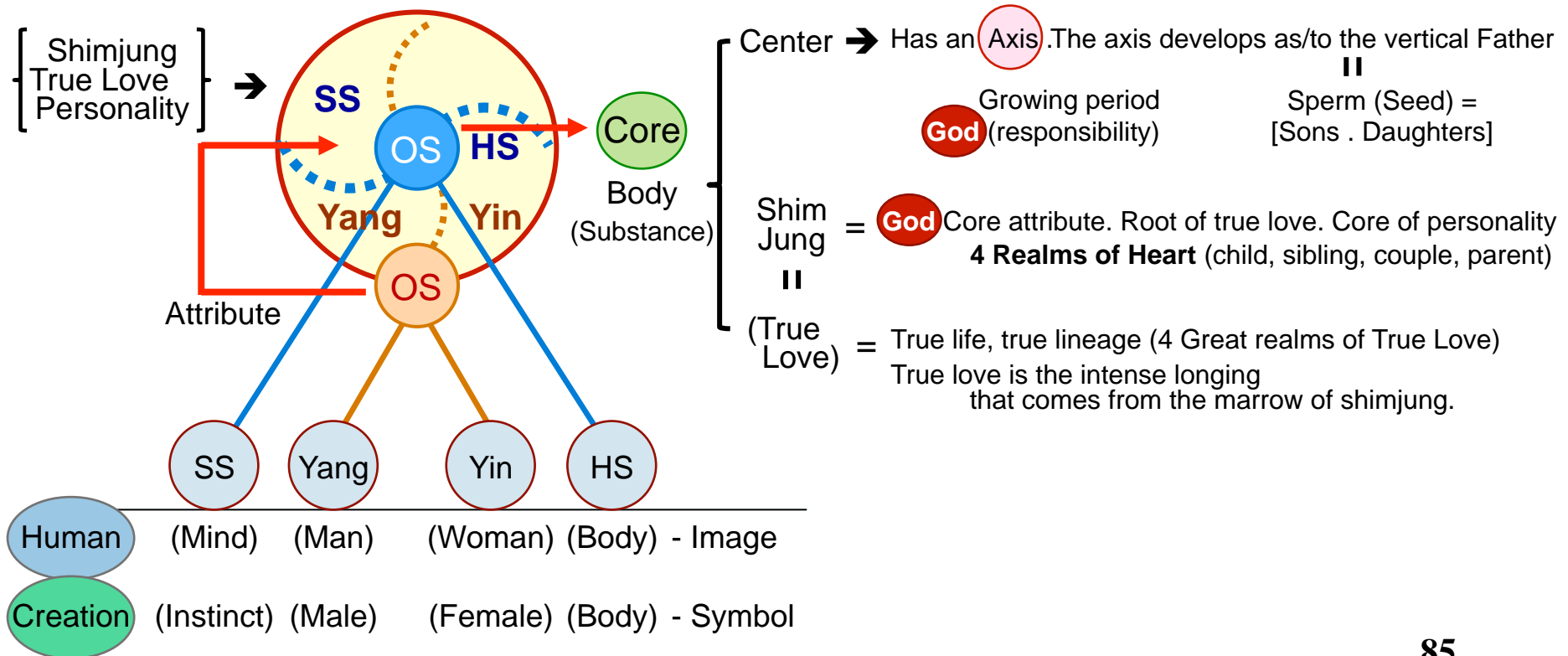

(3) Words of the True Parent

- i. Hananim is the unique, eternal and unchanging being existing from before the generation of the universe.

What caused God to come into being? God came into being because of love.

How did God come into being? God came into being due to love.

How did the basis of the universe come to be realized? There was a seed of love, and this absorbed its counterpart, with the result that Hananim himself came to consist of sungsang and hyungsang.

This took place centering on what? God was formed centering on love. It's just the same as each of you.

The seed of life received by each of you due to the love between your mother and father. Just as one cell grew and then became you, God himself grew in the same way.

For God himself, his eyes formed, his nose formed; this is how he formed. It's exactly the same.

(CSS 207 p.27-28) (CSG p. 1526)

- ii. I searched everywhere in the spirit world, even through all the back alleyways and corners. What I found is that the logic, the governing principle of heaven and earth is simple. That is, the truth is simple. Uncomplicated.

Two become one through an absolute power, and in the vacuum that results, God enters in and becomes like the wick, like the marrow.

Here is where the two different pieces, a man's love and a woman's love, meet and stick together. This is the power of the universe. The ideal substantiation of love comes together and creates the axis of love (CSS 170 p. 171-172).

- iii. Before unifying the physical world, we have to unify the spiritual world.

The root of all heavenly fortune is heaven itself, so how can someone who is unable to digest heaven supposed to bring the result and somehow use it to create the path of the ideal world and then unify the world?

Because of this reality, before unifying the physical world, it is necessary to unify the spiritual world (CSS 191 p. 206).

NB: The teaching by which True Father guided us during all the days of his life on earth:

"Educate about the spirit world," "Do not change or alter my words" (Oct. 6. 2016, Message from the spirit world).

(4) God is self-existent

- i. God is not someone who exists due to someone else, but rather is a self-existent being (Exodus 3:14).

God developed himself as the vertical father from the central axis that is the original root substance of the principle.

The process of developing from the central axis to the position of the vertical father is the growing period for God, and the period for God's own portion of responsibility.

Accordingly, God does not exist due to any other being, and in creating himself, God came to possess creativity and became the **First Lord of Creation**.

In order for human beings, who were created by God, to achieve perfect completion as sons and daughters who resemble God, they must fulfill their own portion of responsibility.

They thus have the responsibility to believe in and practice the word given by God and in this way they create and perfect their own character, which is something even God himself cannot do for them. In this way, human beings come to possess their own creativity and become the **Second Lords of Creation**.

God's development towards becoming the vertical father is the period during which he perfectly completed the 'four great realms of heart (shimjung)'.

The 'Four Great Realms of Shimjung' refers to the child's shimjung, sibling shimjung, couple's shimjung and parent's shimjung.

This period was the period for God to grow himself and fulfill his own responsibility.

Having gone forward to the position of the vertical father, God then moved to create an object through which he could substantially perfect and complete true love centering on these four realms of heart.

Why? Because true love centered on shimjung is always felt, experienced, perfected and possessed through the object.

However, when God created the universe as his object of love centering on human beings, he moved from a position of existing for his self to become a being that invests in his object and exists for the sake of his object.

ii. God cannot be seen

Why is that? Because God is the incorporeal formless original substance, the first cause.

In the case of human beings, our physical body is visible, but our inner person, the spirit self, is not visible.

On the other hand, when we shed our physical body and enter the spirit world, our spirit self will be visible.

Just as the physical body is visible but the mind is not visible during our life in the physical world, in the spirit world the spirit self is visible but the spirit mind, which is the mind for the spirit self, is not visible.

Accordingly, just as the spirit mind (conscience), which is God's body, is invisible, the original mind, which is even more fundamental and can be likened to God's mind, is likewise invisible.

Therefore, shimjung and true love, which are the essential attributes of the original mind, are likewise not visible.

Even so, they are felt and experienced through one's object, and in this way they come to be known.

(ex. air, electricity not visible)

- iii. When human beings are using their physical body, the spirit self is not visible, but when they leave their physical body and the spirit self enters the spirit world, at that point the spirit self becomes visible.

The spirit self has the same appearance as the physical body.

Because the spirit self is a spiritual substance, it is visible.

However, the spirit mind, which is the mind of the spirit self, is invisible.

This is identical to how a human being in his physical body can see his own body, which is substance, but is unable to see his own mind.

Similarly, the spirit mind, which is the mind of the spirit self, cannot be seen.

When the incorporeal God comes and resides in the invisible spirit mind within the spirit self, the perfected spirit self becomes the temple in which God dwells.

Accordingly, the perfectly completed spirit self is the perfection of the spirit mind, and the perfection of the spirit mind is the perfection of shimjung and the perfection of true love, which are God's most essential attributes.

iv. In this way, the human portion of responsibility must be completed during the growing period, so that the principle and law and order are practiced in an absolute way, so that shimjung, true love and character are perfected and so that you become a perfectly completed truth body substance that inherits the seed of true love that possesses shimjung and which is the absolute sex sperm that resembles the original substance of absolute sex and the body of true life that possesses shimjung and which is the absolute sex ovum.

At this time, a person's spirit mind (conscience) becomes the body of God and their original mind, which is the essential attribute of the spirit mind, takes the position of God's mind. In the spirit world, your conscience becomes the body of God (CSS 250 p.156-157).

The most essential attributes of the original mind, which is God's mind, are shimjung and true love.

Accordingly, just as the spirit mind (conscience), which is God's body, is invisible, the original mind, which is even more fundamental and can be likened to God's mind, is likewise invisible.

- v. However, God cannot be seen, but he is the original root of all shimjung and true love, and moreover is the original root substance of the seed of absolute sex true love. Therefore, when one lives a principled life centering on absolute sex true love, one comes into resonance with God as a body that responds to shimjung and true love.

For example, if you call God, saying "Heavenly Father, where are you?" from inside yourself will come the answer "Are you looking for me? Here I am!" (250-157)

This is how you will resonate. And if there is something you want to know, then the answer will appear and be known within your mind. Without time or space, the answer will be heard instantly inside your mind, so that you know.

That place is a place that transcends time and space, and is the place where words are not necessary, where there is only resonance and response.

vi. In this place, when you are happy all of the cells in your body will be happy and when you are sad, all your cells will weep in sorrow.

When you are joyful, all your cells will be joyful and grateful and so happy that they shed tears of joy. Father told us that you have to enter into that place and experience it at least 3 times in your life.

In this way, when I become God's substantial temple, I myself have to disappear.

I have to become the 'me', and only the 'me' who is one body with the father.

In "The Way of God's Will", it says that any word with the (Chinese) character for 'self' is Satan.

In addition, one must not rationalize one's own position under the pretext of the Will.

(5) God of Night, God of Day, Hananim the King of Kings, the True Parent

What kind of person/being is the God of Night and the God of Day? Also, what kind of person/being is Hananim, the King of Kings and the True Parent? We first have to understand the God of Night and the God of Day.

As was previously shown, God, the original root body of the principle, is the harmonized subject of the dual characteristics of original *sungsang* and original *hyungsang*. He exists as a unified body, as the harmonious unified body of his attributes, the dual characteristics of original yang nature and original yin nature.

Referring to original yang nature and original yin nature as attributes of original *sungsang* and original *hyungsang* means that original *sungsang* and original *hyungsang* exist as an invisible, incorporeal unified body wherein both original *sungsang* and original *hyungsang* each have original yang nature and original yin nature as their attributes.

The unified body of original *sungsang* and original *hyungsang* is the core of the universe, the core of the cosmos and the core nucleus of the whole.

This core is the invisible, formless substantial reality.

Why? Because the core is a single point in which the whole is inherent.

This is like subtractive color mixing, in which you get black when you mix all the colors of the rainbow.

Within that final black color, all 7 colors are inherent.

If you go deeper and deeper into that one point, eventually that one point will escape your field of vision, but the point still exists.

That point is darkness. However, light is inherent within that darkness.

Accordingly, when that one point that is darkness is gradually expanded and appears, the light that is inherent within it also appears. In the Bible, it says that God said let there be light, and there was light (Gen. 1:1).

This is the reason why we don't say "day and night" but instead we say "night and day" (Korean).

All beings are created and appear from the God of Night.

In a single day, the new days begins starting from 12 midnight.

Then, when it becomes 12 midday, this becomes the settlement of high noon. The settlement of high noon is the perfectly completed substantial body which contains no shadow. The shadow inherently exists within the substantial body and becomes one body with it.

- God, who is the original root substance of the principle exists through original *sungsang* and original *hyungsang*. Original *sungsang*, which is what we can say is God's mind, is the God of Night, and original *hyungsang*, which can be said to be God's body, is the God of Day.

Human beings who were created to resemble God have both a *sungsang* aspect - mind - and a *hyungsang* aspect - body.

The invisible human mind dwells inherently within the visible human body.

Thus, the mind cannot be seen but the body can.

God's mind aspect - original *sungsang* - cannot be seen but also God's body aspect - original *hyungsang* - cannot be seen.

This is because God is the incorporeal formless original substance, and is the first cause.

In addition, original *sungsang* is mind-type energy and original *hyungsang* is energy-type mind.

In this way, God, the original root substance of principle exists as a pre-energy within the world of cause and that energy is mind, and that mind is energy.

Scientists are referring to this kind of content when they view energy of matter in a vacuum state as a vibrational phenomena and refer to it as having the qualities of particles and waves.

Accordingly, the original root substance of principle is the unified absolute being who is the original substance of energy and is Hananim, the one being who stands as the absolute subject to all created beings.

Because God, as the original invisible and formless substance, cannot be seen, he created human beings to resemble his own *hyungsang* and thereby created them as man and woman (Gen. 1:27).

Here, when we refer to the *hyungsang* of God, we are talking about the unified body in which God's *sungsang* inherently dwells.

Just as original yang nature and original yin nature are attributes of the unified body of the dual characteristics of original *sungsang* and original *hyungsang* in God, human beings were created as men and women with minds and bodies as substantial expressions of God's attributes, that is as unified substantial bodies of dual characteristics resembling God's mind (original *sungsang*) and God's body (original *hyungsang*).

The expression 'attribute' only has meaning within the context of some substantial body.

For example, when we say that a flower is beautiful, it is only because the substantial body that we call 'a flower' exists that we can say that flower 'is beautiful'.

When we say that yang nature and yin nature are attributes of *sungsang* and *hyungsang*, we mean that *sungsang* has both yang nature and yin nature and *hyungsang* too has both yang nature and yin nature.

Also, when the scripture says that human beings were created in the image of God and that God created them as men and women, this means that creation took place centering on the sexes and that the male and female reproductive organs are the image.

Accordingly, the man Adam is the image and glory of God (Cor 1, 11:7), and the woman Eve is Adam's help meet, and his bride.

Centering on God, this man and woman are to each become perfectly complete, to unify their mind and body, and then, as a perfected man and woman, become a couple and then become perfectly completed and unified together.

In this way, when human beings unify their mind and body and become a unified couple as men and women, the God of Night and the God of Day become one, and God, who is the original substance of the principle, becomes unified and perfectly completed himself.

Therefore, if and when the human ancestors Adam and Eve completed and perfected their portion of responsibility (5%), they would have brought perfect completion to the invisible formless God.

Only at that time would the God of Night and the God of Day have fully become the original Lord of Creation, Hananim, as the unified original root body. Only at that time would He have become the King of Kings both in Heaven and on Earth and, as the True Parent, become the eternal True Ancestor of humankind.

Thus, when human beings, who are the central beings of the cosmos, achieve complete perfection, only from that point does God achieve perfect completion, and only from that point does the created cosmos achieve perfect completion as well.

Unfortunately, during their growing period, Adam and Eve were seduced by the lies of Satan and fell through the misuse of sex. Adam and Eve failed to become the perfected substantial True Parents of unified body and mind, and instead became false parents with mind and body in conflict, as owners of a false lineage. As a result, the God of Night and the God of Day came into conflict and God himself was unable to become the king of kings in the spirit and physical worlds. God himself was unable to stand in the position of the true parent of humankind, the owner of the true lineage, or the owner of true peace.

Therefore, when the Messiah, the Lord of the Second Advent, the Savior and True Parent, comes and fulfills the mission of the True Parent, the God of Night and the God of Day will be unified and become the King of Kings on Earth and in Heaven.

Adam and Eve became false parents through the fall and, in a manner opposite to God's ideal of creation, built a fallen world through the vertical and horizontal 8 stages in both the spirit world and physical world. Therefore, the true parent must come and, having discovered the principle of the law of indemnity, restore through indemnity, on earth, the 8 vertical and horizontal stages put in place by the false parent. By bringing restoration through indemnity to completion, conclusion and finalization, the true parent seeks and establishes the kingly authority of God for the first time in 6000 years, thus bringing about full completion of the realm of liberation and realm of release of God, the King of Kings. In this way, the true parent carries out the coronation for the realm of liberation of Hananim, the King of Kings.

True Father completed, concluded and finalized the mission of the True Parent while he was on earth, and became the True Parent of Heaven, Earth and Humankind, the Cosmic King of Peace and the Owner of Lineage.

(6) The Fundamental Law and Axis of the Cosmos

i. The fundamental law and axis of the cosmos is the Father - Son axis.

The fundamental axis of the cosmos is not the law of the Father-Daughter, the law of the Mother-Son, or the law of the Mother-Daughter.

Why is it the Father-Son axis? Because the son is the heir to the Father's seed.

As the father, God is the first generation and Adam, as the son, is the second generation.

The first and second generations are created by God, but the third and fourth generations are multiplied horizontally through women.

The first and second generations are a vertical - Father/Son - lineage relationship, and in the third and fourth generations, the vertical - Father/Son - lineage are multiplied through Adam centering on true love horizontally via Eve.

This is the perfect completion of God's ideal of creation, namely, the Three Blessings (Gen. 1:28).

- ii. Adam is God's son and at the same time is also God's body.
Eve is God's daughter, and at the same time is the wife of Adam.

God meets true love through men and God comes to possess true love through women.

- o Adam who has become one with God is the one who carries God's seed of true love, and for this reason, Adam is subject. Eve, who is the object, receives the seed of God's true love through Adam and multiplies God's sons and daughters.

iii. **Man has the seed; woman does not have the seed.**

The seed in man's sperm includes two types - seeds that can become a son and seeds that can become a daughter.

Woman, however, does not have a seed. Rather, a woman is the field in which a seed is planted.

In order for the sperm seed of true love to meet with the ovum, which is the body of the life of true love, the two must come together at one place through the power of true love.

This one place, one point, is the place where the vertical and horizontal 3 existences must be met.

That is, the vertical original root substance of true love, God, must meet with the horizontal Adam and Eve centering on God's true love.

The place where this happens is **the reproductive organs of the man and the woman.**

- Accordingly, the reproductive organs are the most precious part of the human body, and are the most precious place in the entire cosmos.

Centering on the reproductive organs, God, Adam and Eve become one body in true love, true life and true lineage.

The important thing here is lineage - 'bloodline'. (Korean '*hyeol tong*')

In Korean, we do not say 'love line', or 'life line'. Instead, we say 'bloodline'.

Lineage bears fruit through the reproductive organs of men and women centering on God.

This is why God gave ownership over the sexual organ to the partner.

Adam is the one who has Adam's sexual organ, but it does not belong to Adam. Rather, it belongs to Eve, his counterpart. Eve is the one who has Eve's sexual organ, but it does not belong to Eve, but to Adam.

- Because one's counterpart is the owner of one's sexual organs, which are so precious, this makes your counterpart the most precious being in the whole cosmos.

Because of this, human beings are central to the cosmos.

Accordingly, when a man and woman become perfectly complete, the cosmos itself is perfectly complete and the creator of the cosmos, God, becomes the owner of the cosmos from that point forward.

- Horizontally speaking, Adam and Eve are the owners of their counterpart's sexual organ. The vertical owner of their sexual organs, however, is God, the original root substance of true love.

It is critical to correctly establish an absolute sex, true love absolute value system centering on the reproductive organs. When such an absolute value system is established, the most basic and fundamental problems in the real world will be resolved, and the ideal world of God's creation, the world of peace, unity and happiness, will be realized.

- If Adam and Eve had achieved perfection by fully maintaining absolute sex in the Garden of Eden, as per God's commandment not to eat of the Fruit of the knowledge of good and evil, at that time, God would have taught them who the owner of their sexual organs is.

The granting of eternal permission to the owner of their partner's sexual organ is God's eternal blessing, and through this, Adam and Eve would come to realize that, vertically speaking, the true owner of their sexual organs is the invisible original root substance, God.

At that time, the one point, the one place where God and Adam and Eve all come together would be the reproductive organs of Adam and Eve. That one place is what we call Marriage.

Accordingly, the marriage of Adam and Eve is God's marriage, and the 'first love' experience of Adam and Eve is God's 'first love' experience. The sons and daughters of Adam and Eve would be God's sons and daughters.

At that time, Eve's sexual organ receives the seed of God's true love through Adam and becomes the palace of true love, the palace of true life and the palace of true lineage.

This is why, in Korean, we call the womb the 'ja-kung' (child's palace; palace of the child).

The womb becomes the palace in which the princes and princesses grow up.

The man's sexual organ is the organ for planting the seed of the sperm of God's true love.

Thus, both a man and a woman must maintain absolute sex purity prior to getting married. In addition, they must also preserve absolute sex purity and fidelity after getting married.

3) Conclusion: What Kind of Being is God?

(1) God is the absolute one being Hananim, the original root substance of Principle.

As a self-existing being, God is also an absolute, unique, unchanging and eternal being.

(2) The original root substance of Principle is the harmonious subject that exists as the original substance of energy, and as the harmonized unified body of the dual characteristics of original sungsang and original hyungsang, God is the unique being of oneness, the True Heavenly Father.

(3) God, the original root substance of principle, is the original substance of shimjung, true love and true personality.

God is the original substance of principle, law, and order.

(4) The most essential attributes of God are shimjung and true love.

True love is that which invests and forgets and then invests again for the sake of the other.

True love is the sense of longing experienced in the very marrow of shimjung.

(5) God, the original root substance of principle, exists as a positional relational being through the relationship of subject and object

- (6) God, the original root substance of principle, is the absolute sex original substance of true love, true life and true lineage.
The sons and daughters of God must preserve absolute sex without fail for the sake of families of absolute sex, absolute purity, pure lineage and chastity.
Purity and chastity must be seen as absolute, unequivocal values.
- (7) When human beings, made in the image of the original root substance of principle, reflect in division the dual characteristics that are an attribute of God, those attributes appear as man and woman.
Man possesses the seed of true love that has the shimjung of the absolute sex sperm of God. Woman possesses the body of the life of true love that has the shimjung of the absolute sex ovum of God.
- (8) God, the original root substance of principle, is the original root body of the personality of intellect, emotion and will, and truth, beauty and goodness, centered on shimjung.
- (9) God, the original substance of principle, also has a growing period and a portion of responsibility to fulfill.

- (10) God, the original root substance of Principle, is the owner of conscience and the owner of life.
- (11) Adam and Eve were raised in and emerged from the bosom of the God of Night. Jesus, who came as the next Adam, was also raised in and emerged from the embrace of the God of Night.
- (12) True Father, who is the True Parent, was also raised in and emerged from the embrace of the God of Night.
- (13) The True Parent is the owner of peace and the owner of lineage.
- (14) The God of Night, the God of Day and the King of Kings Hananim, was liberated and released by the True Parent.
- (15) True Father, the True Parent, is the substantial True God.

5. How did the Universe come to exist?

1) Creation? Evolution?

→ Creation. Why Creation?

(1) All existences come into being and are born from love.

This is why all beings exist in pairs.

Science: Input > Output, **Love:** Input < Output

(2) Seeds are different (sparrow - finch).

A seed is absolutely unique and does not change for eternity.

(3) New developments always require an investment of creative force (new idea, technology).

Without such an investment, there is no development.

Development → When A becomes A' ($A \rightarrow A'$), that is development.

Evolution → When A becomes B ($A \rightarrow B$), that is evolution. (Monkey → Human being)

(4) What comes first? The existence, or the reason for the existence?

The reason comes first. Why? Because motivation and purpose come first.

Conclusion: Through creation, not through evolution

This puts an end to the controversy over Creation vs. Evolution
(Declaration of the End of the Theory of Evolution)

2) Pantheism, Emanationism (Plotinus)

Creation has no motivation or purpose.

3) Spontaneous Generation (Big Bang Theory)

- Some scientists established the theory of the Big Bang in relation to the formation of the universe and have worked hard to rationalize that theory.

These scientists assert that the universe was formed approximately 20,000,000,000 years ago, when an extremely small particle with a diameter of 10 cm responded to an unlimited force triggering the big bang, and that the universe was formed from inflationary action caused by that big bang.

In addition, they say that the same force that formed the universe by acting on that extremely small particle to cause the big bang is what maintains the universe and that the expansionary action that was caused is continuing on even today, 20 billion years later.

However, no scientists are able to predict how long the expansion of the universe will continue.

If the expansion continues forever, it means that some unlimited force acted upon that 10 cm-sized particle, and this itself becomes a field transcending science.

Accordingly, the Big Bang theory itself becomes contradictory inasmuch as it ends up denying science itself.

○ Theory of the Generation of the Universe

Unlike the theory of a shimjung motivation behind the universe, there are other theories about the generation of the universe that assert that the universe formed from some source or origin automatically without any purpose or motivation.

In the East: Yin-Yang Great Ultimate Theory of the I Ching,
The Natural Beings Theory of Confucianism

In the West: Plotinus' Emanationism (Pantheism)
Hegel's Self-development of Absolute Spirit Theory

In India: Hindu Theory of Generation of All Things (Brahman)

Big Bang Theory of Modern Science, etc.

However, these theories of the formation of the universe establish a perspective that says human sin also developed automatically, by itself. Thus, we cannot resolve sin on a fundamental level on the basis of these theories.

When we adopt a universe creation theory, we need to have a clear understanding of God, who created the human beings and the universe, and the purpose for which human beings and the universe were created. If we do not clearly understand God and the purpose of creation, it is impossible to bring a fundamental resolution to sin.

Moreover, if we cannot resolve the fundamental root of sin, it will be impossible to realize Cheon Il Guk, the sinless world of peace and unity desired by God and humankind.

4) Creation of the Universe from the Viewpoint of Wollî Boncheron

Wollî Boncheron, aka the Unification Principle, makes it possible to offer a reasonable, logical explanation.

- (1) Because God's creation of the universe started from a single point, the view of *Wollî Boncheron* is that God first created a single particle from energy, and then step by step created atoms, then from atoms created particles.

Following this, after creating various minerals which are formed from those particles, God created organic matter → vegetation → animals in that order, then finally God created human beings as the substantial embodiment of minerals, plants and animals elements. God created human beings in his image as his children.

- The universe is the stage for the activities of human beings. For this reason, human beings are able to flourish and prosper in the universe. In this sense, the universe is the homeland of humanity, and the cosmos (spirit world and universe together) is the original home country of humankind.

Accordingly, the view of Wolli Boncheron is that the universe will continuously expand and that the energy of the universe did not simply appear instantly. Rather, the energy of the universe is cumulative, having been added step by step in each stage of creation over a long-term creation process.

(2) As the harmonious unified body of the dual characteristics of original sungsang and original hyungsang, God is the unique being of oneness, who exists as the harmonized subject being.

Original sungsang (mind-type energy) and original hyungsang (energy-type mind) exist as the original root substance of energy, and as pre-energy in the world of cause.

This pre-energy is mind, and we can also say that mind itself is energy.

Research into matter and material is the job of scientists.

Modern science has revealed that the source of matter and material is energy.

However, before matter came into existence, God's hyungsang itself existed. Moreover, God's hyungsang included energy, and the mind energy of the sungsang was inherent within the energy of God's hyungsang. Accordingly, the pre-energy of the world of cause is mind, and mind is itself energy, and the unique being of oneness is thus the original root substance of energy.

When we say that energy is mind, we can liken this to energy in a vacuum state and the vibrational phenomena it displays.

- That is, by continuously adding energy and having it act in a physical vacuum state, particles will appear together with the vibrations in the energy.

The vacuum state at this time is not continuous, but appears in stages.

In the same way that scales appear in music, stratum of vibration occur within energy, and in response to those stratum, particles appear.

- Just as scales will appear in singing in response to the human mind, we must conclude that the stepwise vibrational phenomena in energy appears because of the action of some mind-type element upon it.

When we say that energy has strata, we are saying that differences occur in the mass of the particles, giving rise to the logic that ultimately the properties of the particles are regulated or stipulated by a mind-type aspect. If and when natural science inductively reveals this fact, the unification of science and religion will become possible.

(3) God, the original root substance of principle, has the relational nature of subject and object. God is the harmonious unified body of original sungsang and original hyungsang, and is the harmonized unique being of oneness.

Original sungsang and original hyungsang have a relationship of subject and object, and original yang nature and original yin nature, which are attributes of original sungsang and original hyungsang, also have a relationship of subject and object.

○ The difference between subject and object is a difference of positional role and a difference of locational position.

The expression 'kyeok-wi' (positional role) expresses that man is the masculine subject while woman is the feminine object.

From a locational position point of view, man has the subject role and woman has the object role. The subject has the right side, and the object has the left side.

In this case, subject cannot be object, and the object cannot be the subject. This is the same as how a man cannot become a woman, and a woman cannot become a man.

Here, principle and law and order apply, without exception.

In other words, an individual has certain moral standards and norms that must be kept, and a family also has certain moral standards and norms that must be adhered to. The universe has a principled order. All these are examples of the 'Cheon Do' or 'heavenly way' which prescribes how individuals, families, and the universe itself must exist, move and act.

Thus, if men and women leave their correct positions and do not live in a principled manner as beings within their correct positional roles, they become unable to complete or perfect the purpose for which God created them.

- If a being leaves its correct position, the reciprocal partner being has no choice but to wait until the departed being returns to its correct position. It must persuade that partner being to return.
- Perfection and completion are not something that can be achieved alone, but only through one's counterpart.

Accordingly, all beings exist in a relational way and exist for the sake of their counterpart.

Thus, each must live for the sake of the other in order to achieve completion and perfection. Existing for the sake of each other means to both exist for the sake of one's counterpart's perfection, and to exist for the sake of the completion of God's purpose of creation.

If you live for your counterpart, you will perfect and complete your counterpart, and perfecting / completing your counterpart means, in essence, perfecting / completing yourself.

A subject and object must be, love and live for the sake of God vertically and for each other horizontally.

As it says in the Scripture, high places shall be made low, and low places shall be raised. The thought expressed in the Korean saying '*kyung cheon ae in*' (respect - heaven - love - human beings) is imbued with the same meaning.

- **The Universe is Vast and Unlimited**

How big is a galaxy from the viewpoint of solar systems?

Cosmological scientists estimate that our galaxy has some 100 billion stars.

If you counted to 100 billion at a rate of 1 count per second, it would take you 3200 years.

Scientists also say that the distance between the stars in our galaxy is tens and hundreds of thousands of light years.

In addition, they estimate that there are hundreds of billions of such galaxies in our universe.

5) Fundamental Principle behind the Motion of the Universe

The state and motion of the universe were always thought to be both highly complex and hard to understand. Thanks to today's dazzling scientific advances, however, we have come to understand that countless physio-chemical and astronomical laws control the natural world.

Nonetheless, as far as the state and motion of the universe is concerned, there are still many unknown areas .

- Regardless of how many minute, complex and subtle phenomena the motion and state of the universe gives rise to, the basic principle of that state and motion is the 'Principle of Give and Receive Action', that is, the 'Principle of the 4-Position Foundation'.
- Only in the fallen world and the world of sin, that is to say, only in fallen human society are these fundamental principles not functioning, giving rise to a multitude of complex problems.

Accordingly, fundamental solutions to today's individual, family and global problems can only be established if and when these fundamental principles are applied correctly to human society.

III. The relationship between God and Humankind

1. Mind – Body Relationship (Human Beings are the second God)

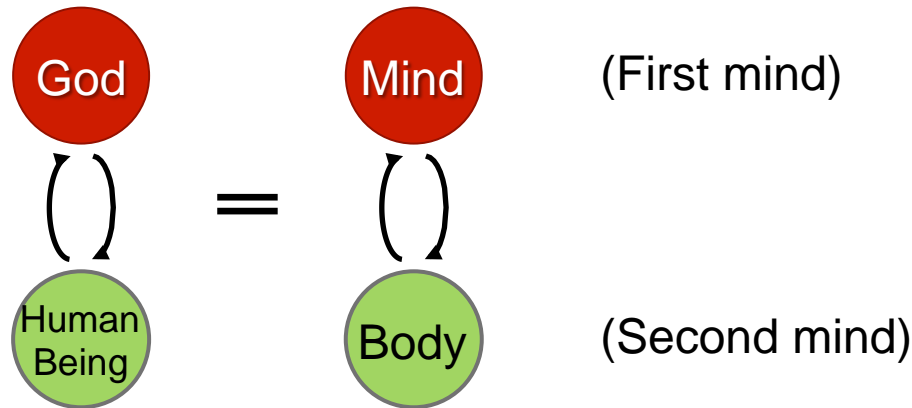

(Second God)

Human beings are the
second Hananim

Look at human beings as if they are God,
Listen to human beings as if they are
speaking God's words,
Uphold the sacredness, value, dignity of
human beings.

2. Father – Son Relationship

All beings must have parents in order to exist.

Parents must have children in order to be parents.

The greatest hope of any human being is to become a true parent.

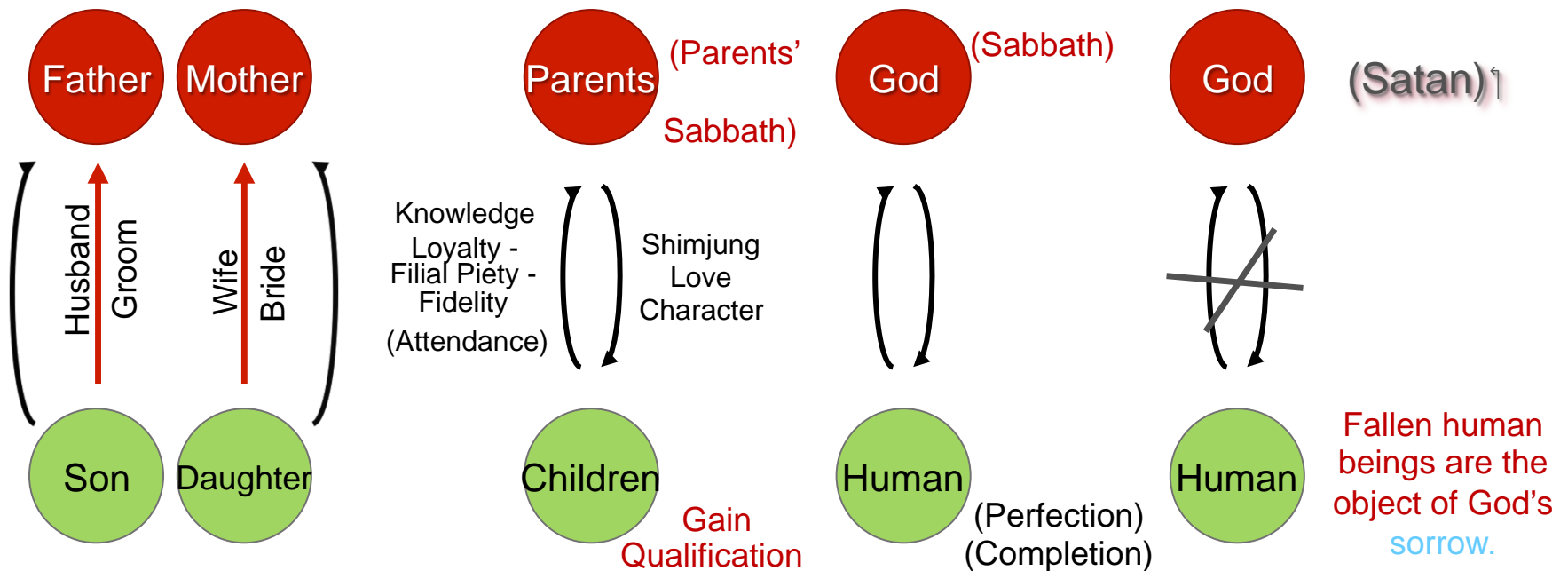

1) Adam and Eve are Children of God.

True love moves through the shortest, most direct line

(True Love → True Life → True Lineage)

Adam God's son and at the same time, God's body

Eve God's daughter, and at the same time, Adam's wife

The marriage of Adam and Eve is God's marriage (Manifestation of the Substantial God).

The First Love of Adam and Eve is the First Love of God.

Up until the present, God has not been able to use a body in order to experience substantial love.

God's substantial love experience is only realized and firmly established after the appearance of the True Parent. →

2) All Beings are Born from Parents (Lineage) – Offspring are the Complete Substantial Body of Their Parents.

❖ 4 Key Principles of Coming into Being

1 Children come from the love of their parents.

2 Children come into being belonging to their parents.

3 Children come into being for the sake of their partner.

4 Children come into being for the sake of eternal life.

3. To become God's True Sons and Daughters....

- i. We must resemble God. Children must resemble their parents (int. character, external form, lineage).
- ii. A true human being is a human who resembles God.

	Hananim	Human Beings
i.	[Sungsang – Hyungsang Yang nature – Yin nature] Unified Body	[Mind - Body Husband - Wife] Unified Body
ii.	Essential Attribute: <i>Shimjung</i> (Heart)	Essential Attribute: <i>Shimjung</i> (True Love, Life, Lineage, Absolute Sex)
iii.	Motivation for Creation : <i>Shimjung</i> (Heart)	Motivation for living : Shimjung (Heart)
iv.	Creation [Investing one's self Development of self]	Creation of Character [Investing oneself Development of self] Living for others (Sacrifice, Service)
v.	Absolute, Unique, Unchanging, Eternal	Absolute, Unique, Unchanging, Eternal (Individual, Couple, Family)
vi.	True Love, True Life, True Lineage (Absolute Sex)	True Love, True Life, True Lineage (Absolute sex)
vii.	Absolute Faith, Absolute Love, Absolute Obedience	Absolute Faith, Absolute Love, Absolute Obedience (Absolute Owner)
	God's Create human beings who responsibility : resemble His own nature	Human responsibility : Must resemble God Concrete Details = <i>Shimjung, True Love, Character, Principle, Order, Law, Absolute Sex</i>

Absolute Sex = Absolute Divinity (Character)
 Completion of God's Portion of Responsibility =

Absolute Sex = Absolute Character (Divinity)
 Completion of Ideal Oneness of God & Humankind in Love

Conclusion

- i. God is my parent. → I am God's Child.
- ii. A true human being is a human being of absolute sex, shimjung and true love resembling God.

4. True Education

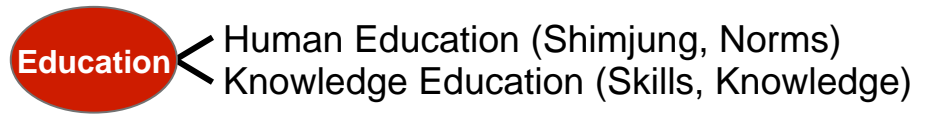

1) In order to become God's True Children

Education Ideal Gen1:28	Education Concept	Education Methods	Education Goals	
3 Great Blessings Purpose Of Creation God's Will	Be Fruitful	Wholeness (Perfection of Individual)	Education of Heart	Person of Character
	Multiply	Multiplication (Perfection of Family)	Education of Norms	Good People
	Dominion	Governance (Perfection of Dominion)	Knowledge Education (Skills & Ability)	Genius

Matt. 7:21 He who does the will of the Father will enter Heaven.

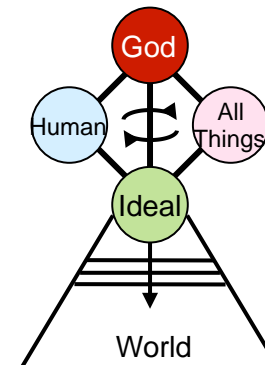
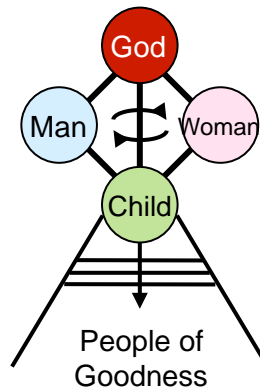
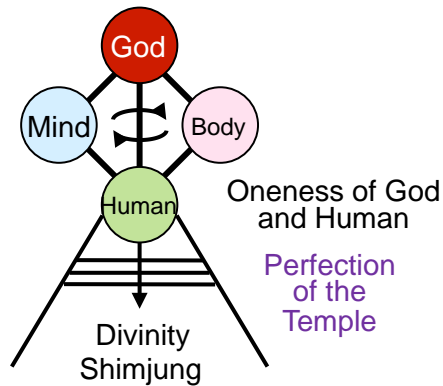

- Educate clearly about God, the Spirit World, the True Parent and Restoration through Indemnity (Live the Principle)
- Unification Education fulfills the 3 key elements of unification of culture: Unity of *Shimjung*, Unity of Thought, Unity of Lifestyle. The Core True Education Concept = Love God, Love Humankind, Love My Nation

5. Dual Characteristics are the key to solving all problems of the world.

1) Sungsang & Hyungsang are the Master Key.

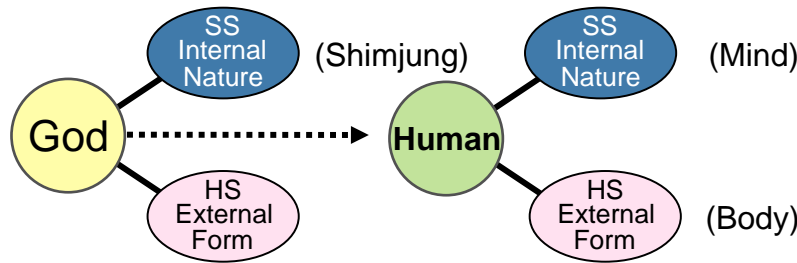

All things were created with human beings as the model.

Accordingly, all places where people gather & live should fulfill their value and purpose for existence through a balance of *sungsang* and *hyungsang*.

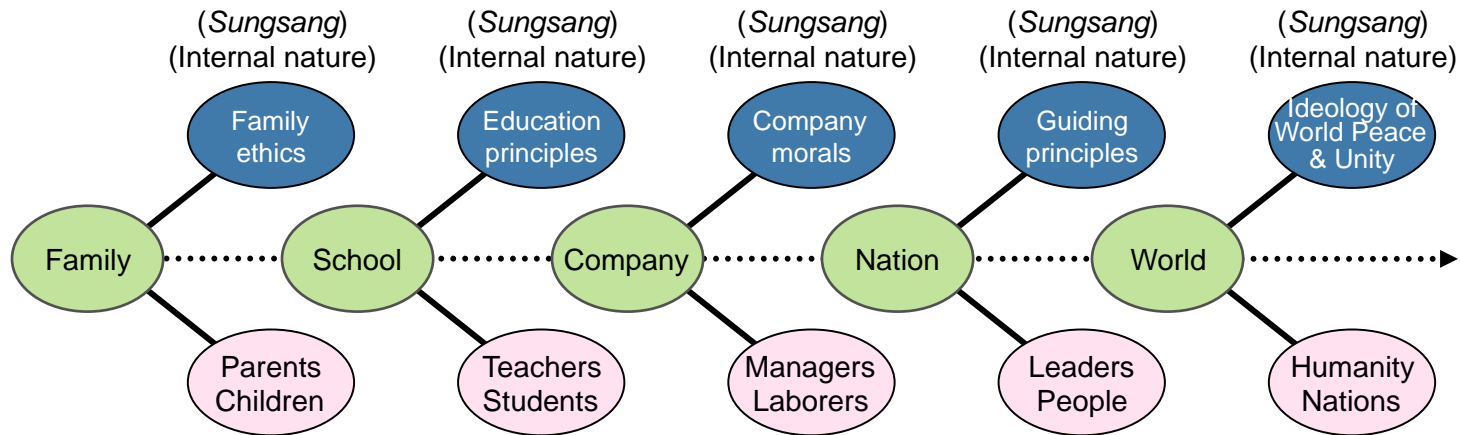

A *Sungsang*-type value system must be established.

Unification of value systems **➡** Absolute Goodness

(Life of *Shimjung* = Life of living for the sake of others)

2) Yang & Yin as attributes of *Sungsang* and *Hyungsang* and the Resolution of Real Problems

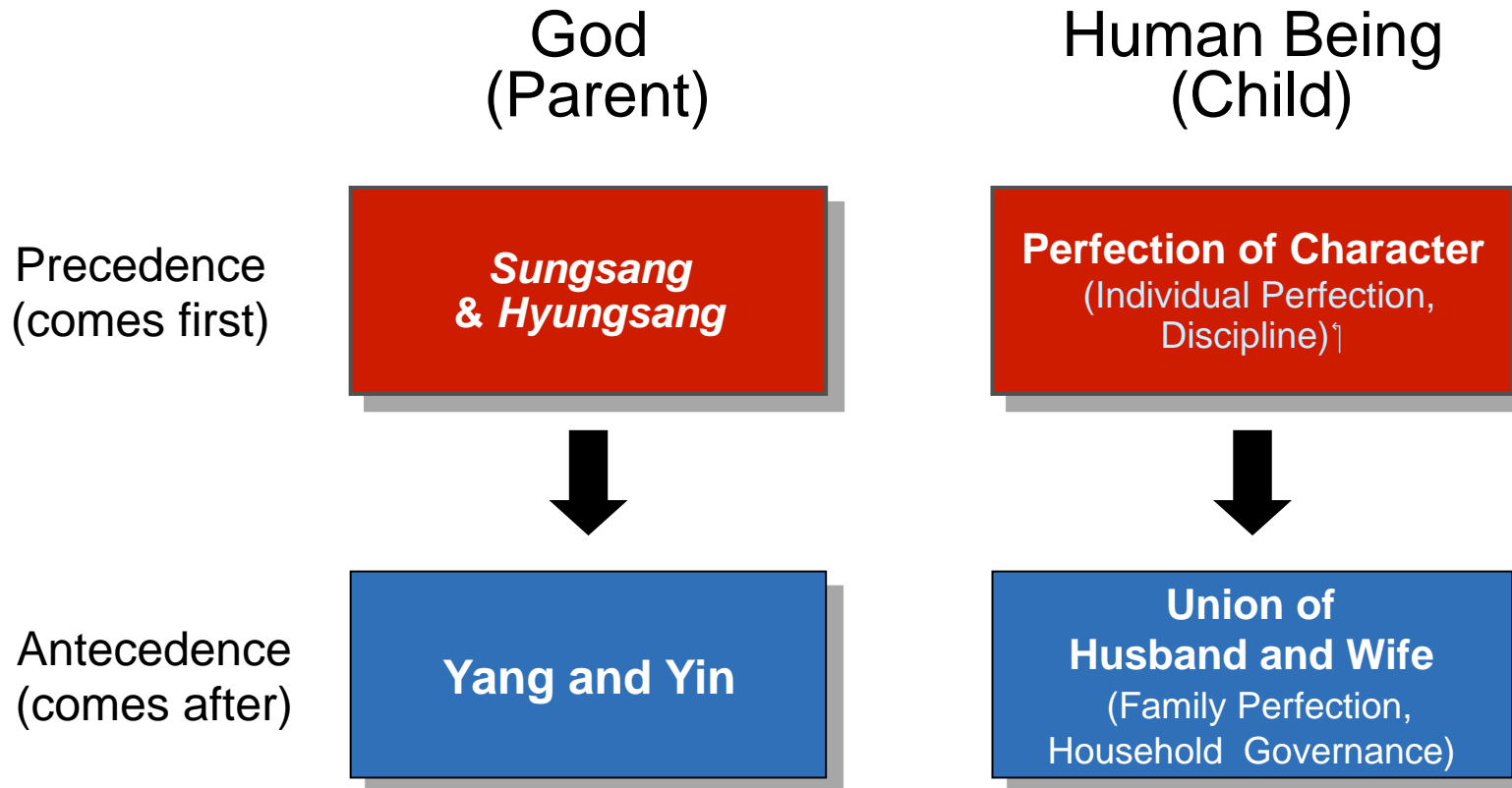

6. The Final Human Revolution

i. Industrial, political, religious, cultural revolutions

Solve problems? No. Unified World of Peace? No. Happy World? No.

ii. Human Revolution

○ Past revolutions — Guns, Swords, Force

○ How will the Human Revolution take place? (True Education)

○ What will be the instruments of the Human Revolution?

(True Love and Principle with their source in *Shimjung*)

○ The Human Revolution →

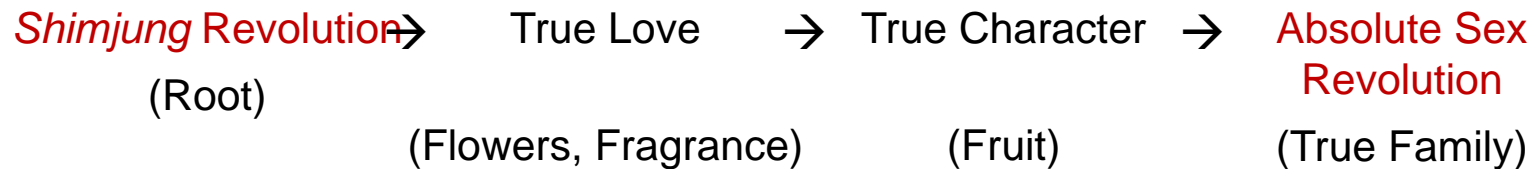

IV. The Relationship between God and the Creation

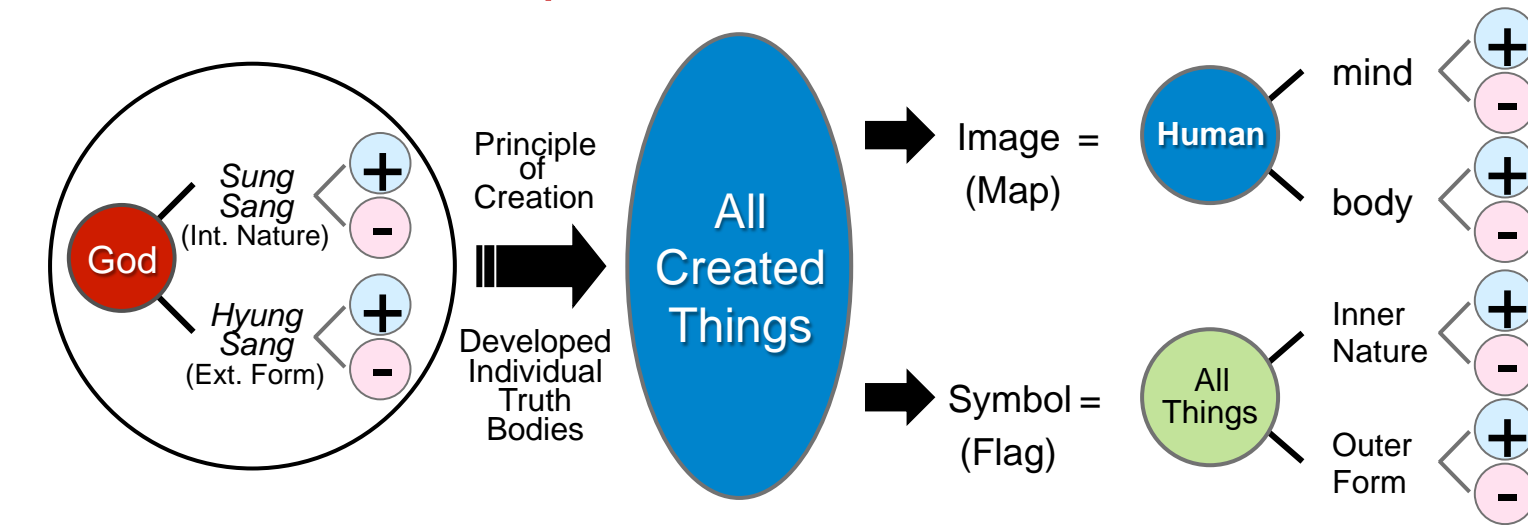

↑

Subject	Object
Cause	Result
Internal	External
Vertical	Horizontal
Invisible	Tangible
(Masculine Subject)	(Feminine Object)

↑

Relationship

Human Beings	All Things
Imitation by Voice Box	Sounds of All Things
Possesses All	Elements, Qualities, Nature
5 Organs and 6 Bowels	5 Great Seas 6 Continents
12 sets of Ribs (24 in all)	12 months, 24 Solar periods
Hair	Plants
Skin	Earth's crust
Muscles	Substrata
Veins	Underground waterways
Skeleton	Rocky mantle
Bone marrow	Molten core

1. The I Ching & the Bible from the Perspective of Principle of Creation

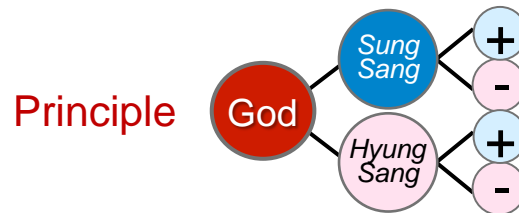
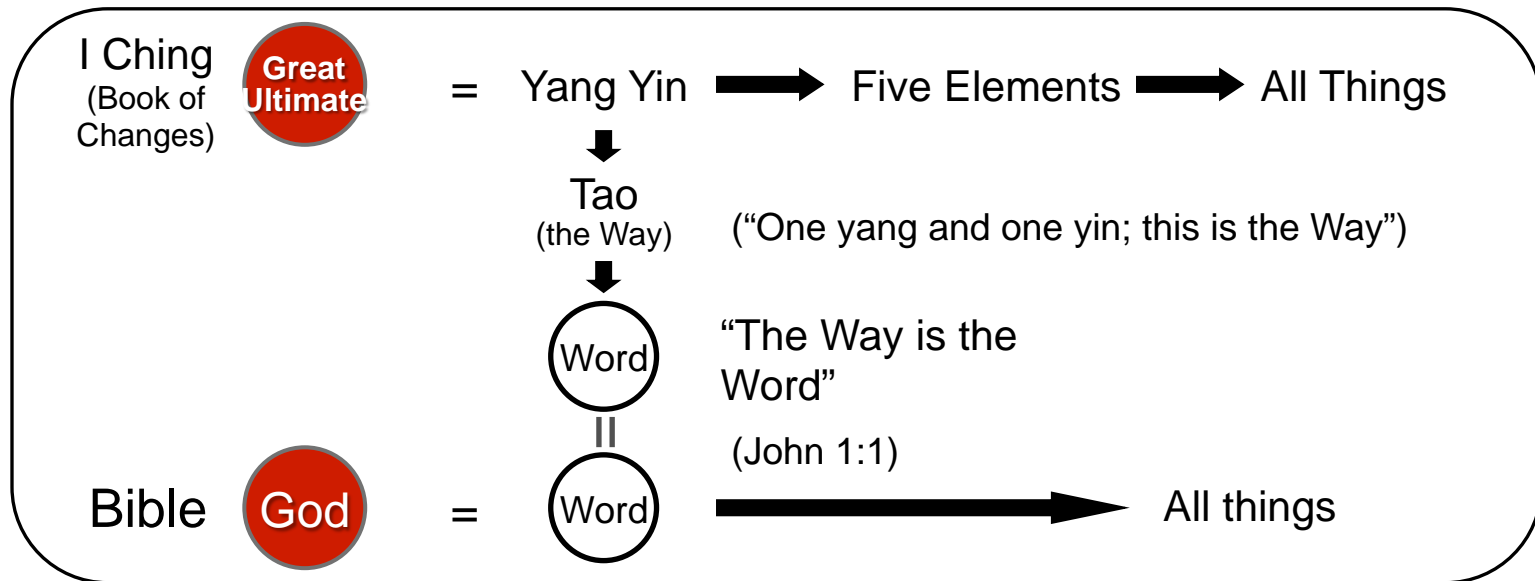

The fundamental issues of the I Ching and the Bible are explained by the Principle of Creation, allowing for the unification of Eastern and Western Philosophy.

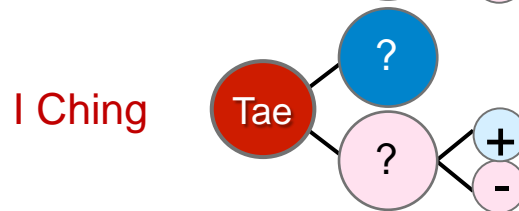

Cannot explain that God is a being of personality (Yang Yin)

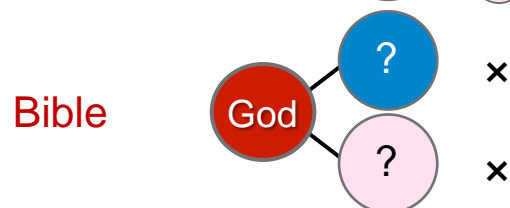

God =the Father (explains that God has personality), but does not explain God’s attributes

2. Theory of Original Substance in West and East from the Perspective of Principle of Creation

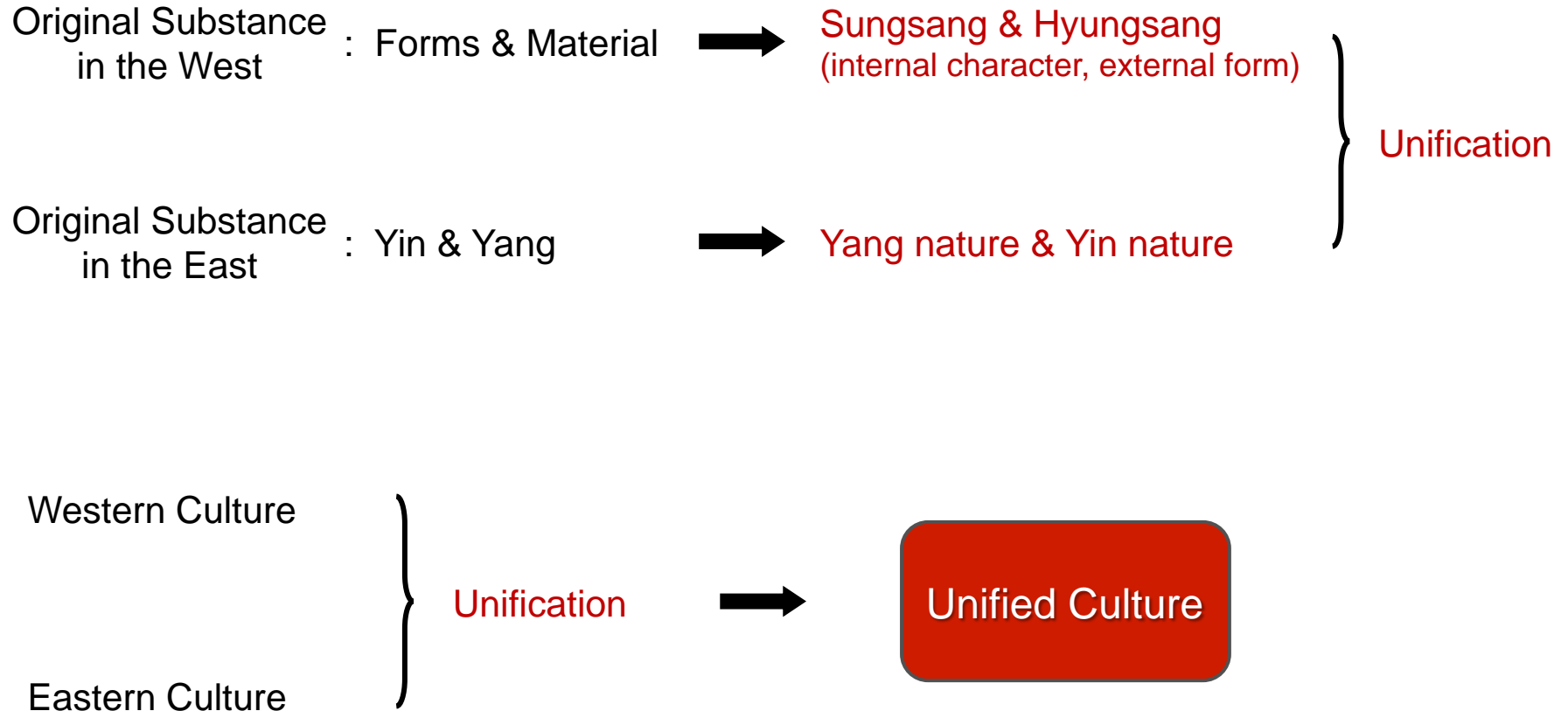

II. Universal Prime Energy, Give and Take Action, and the Four Position Foundation

1. Universal Prime Energy

Existence → Requires Energy

Universal Prime Energy {
i. The fundamental force for God's existence
ii. Causal force that gives rise to the energy that allows all created beings to exist

Without exception, all existences require energy and force in order to exist. This is true for God too. God himself also requires a force in order to exist. Universal Prime Energy is the fundamental force that generates the energy required by all beings created by God for their own existence.

Because God is absolute, unique, eternal and unchanging, the force of God's existence, namely Universal Prime Energy, is itself absolute, unique, eternal and unchanging as well.

2. Give and Receive Action

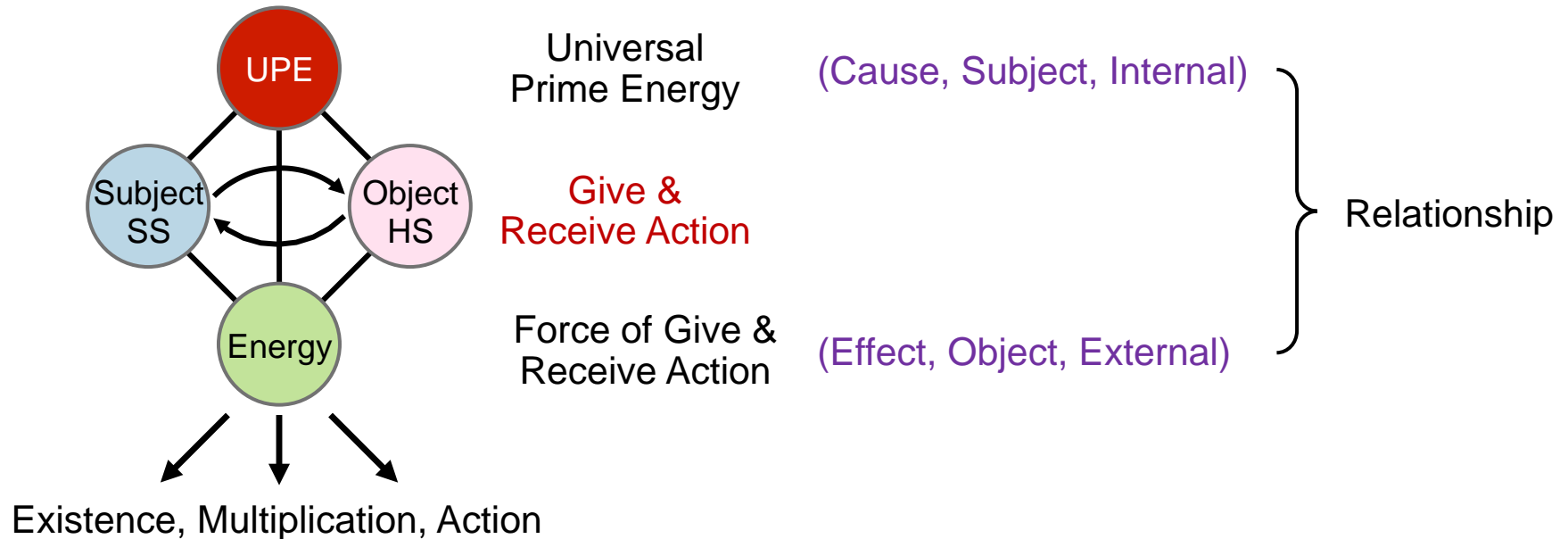

1) Relationship b/n Sungsang and Hyungsang & Give and Receive Action

- In Wolli Boncheron (Theory of Original Substance of Principle), which is the Unification Principle, when sungsang and hyungsang establish a “reciprocal relationship” to form a “reciprocal common base”, the “phenomena of giving and receiving something” takes place. This phenomena is what we call Give and Receive Action.

- Here, when we say the two partners establish a “reciprocal relationship”, we mean that they face towards each other, and when we say that they form a “reciprocal common base”, we are saying that they establish a “reciprocal relationship” centering on a “common purpose”, then engage in give and receive action and exist by establishing a reciprocal common foundation.

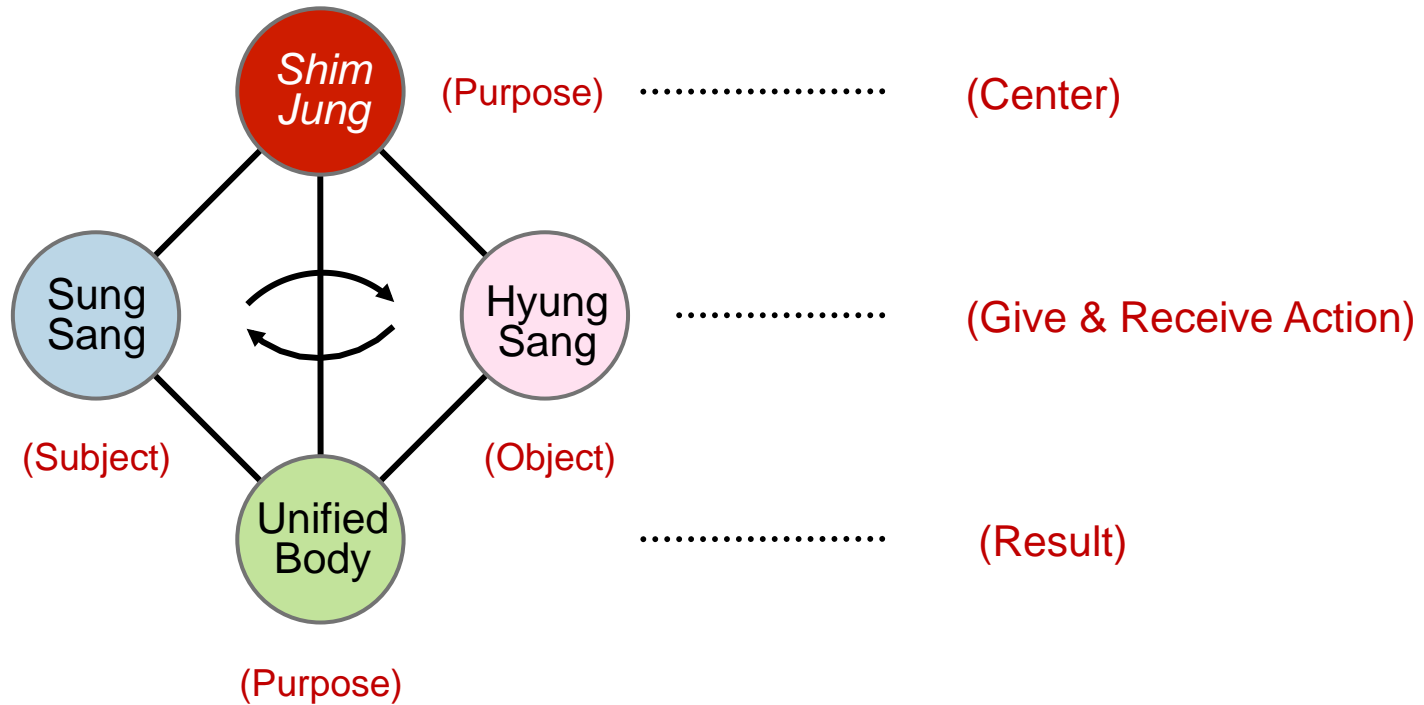

2) Two Preconditions Necessary for Give and Receive Action

In order for give and receive action to be engaged, two preconditions are necessary.

(1) First Condition – A **Center** must be established prior to give and receive action.

(2) Second Condition – Following the completion of give and receive action, a set **Result** must appear.

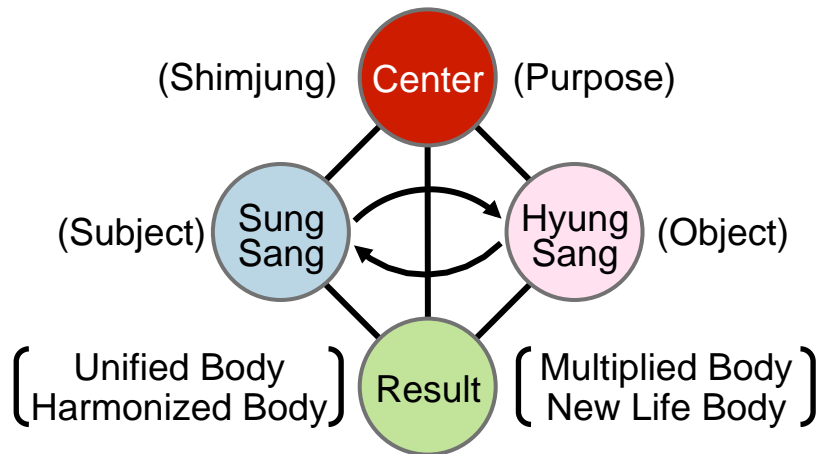

i. 'Reciprocal action' that involves no **Center** or no **Result** is nothing more than 'reciprocal action'; it is not give and receive action.

ii. The Center of give & receive action between God's attributes is in some cases '*shimjung*' and in other cases 'purpose'.

- When **Shimjung** is the 'Center', the 'Result' is a 'Unified Body' (Union, Harmonized Body)
- When **Purpose** is the 'Center', the 'Result' is a 'Multiplied Body' (New Life Body)

3) Properties & Features of Give and Receive Action

In any situation or at any time, Give & Receive Action displays 'completeness/integrity', 'harmony/smoothness', and 'balance/harmony'.

4) All Beings are Relative Beings (Co-responsive Beings)

Why relative beings? For the sake of Give & Receive Action ➡ Development

What do they give and receive? Love & Beauty ➡ Joy ➡ Happiness

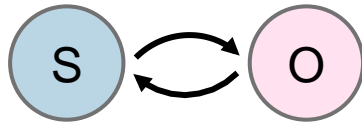

Human Beings	Parents	Children
	Husband	Wife
	Teacher	Student
	Superior	Subordinate
	Employer	Employee
	Government	Citizens
Animals	Male	Female
Plants	Stamen	Pistil
Minerals	+	--

Universe

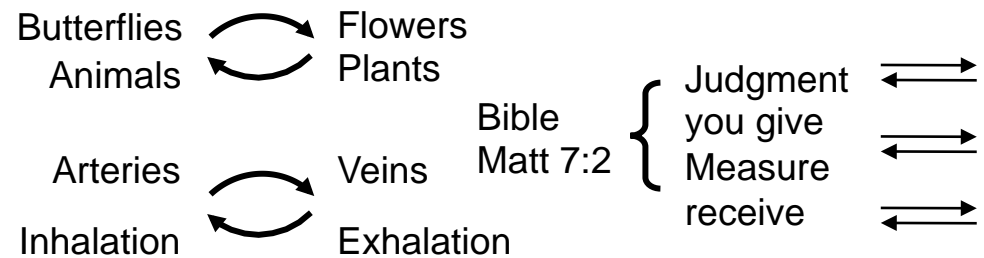
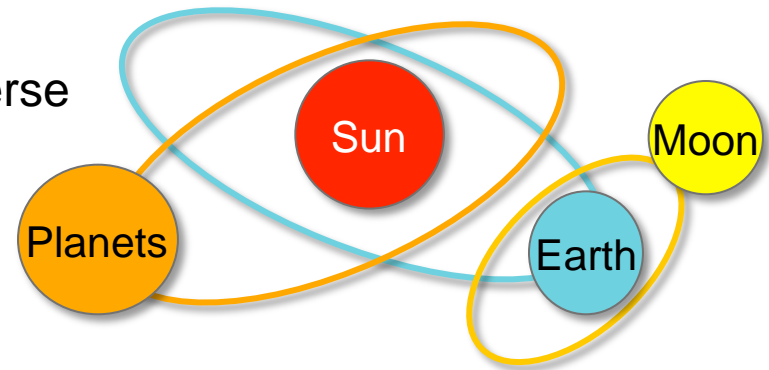

5) Action of Conscience from the Perspective of Give and Receive Action

The Force of Conscience

- Generated by give and receive action
- Acts upon all people guiding them towards goodness
- True subject partner of the conscience is God

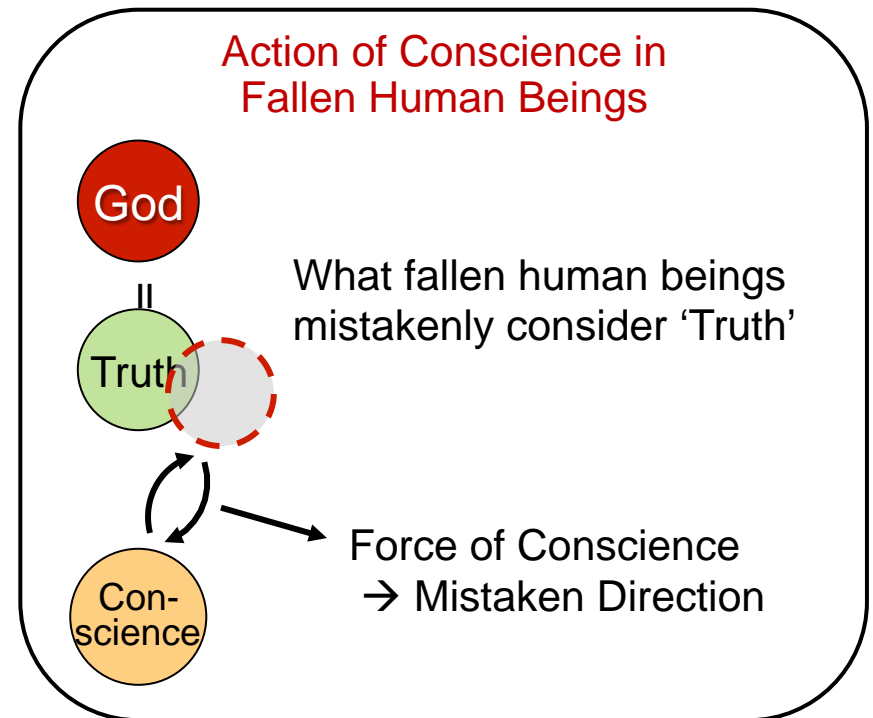
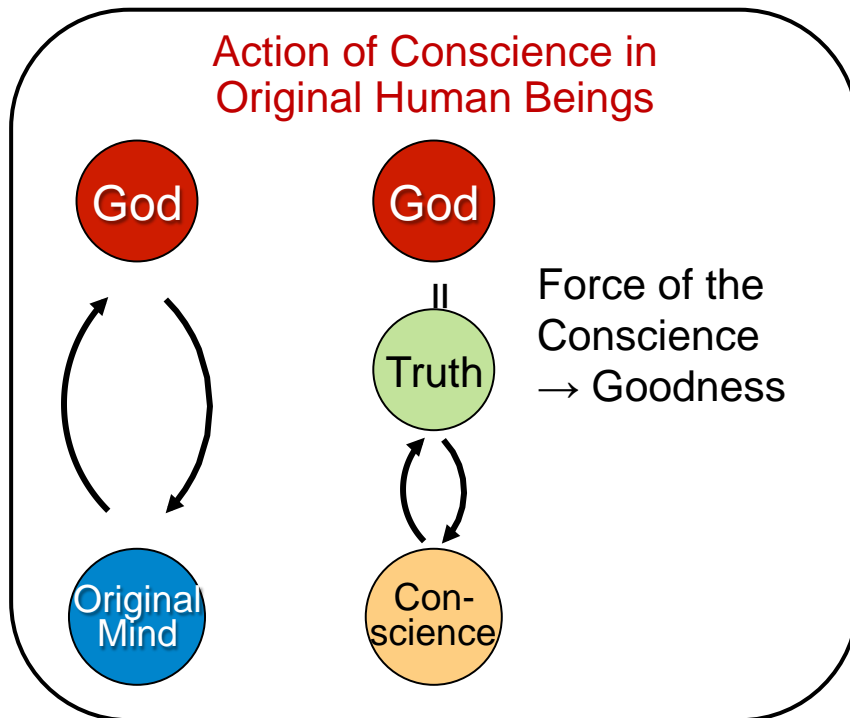

6) Fall and Salvation from the Perspective of Give and Receive Action

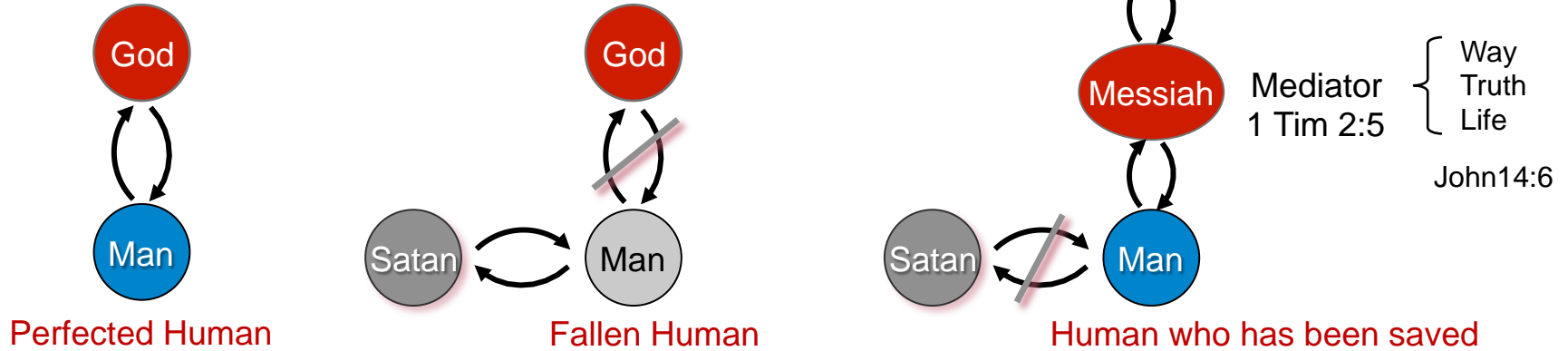

7) Action of the Original Mind and the Conscience from the Perspective of Give and Receive Action

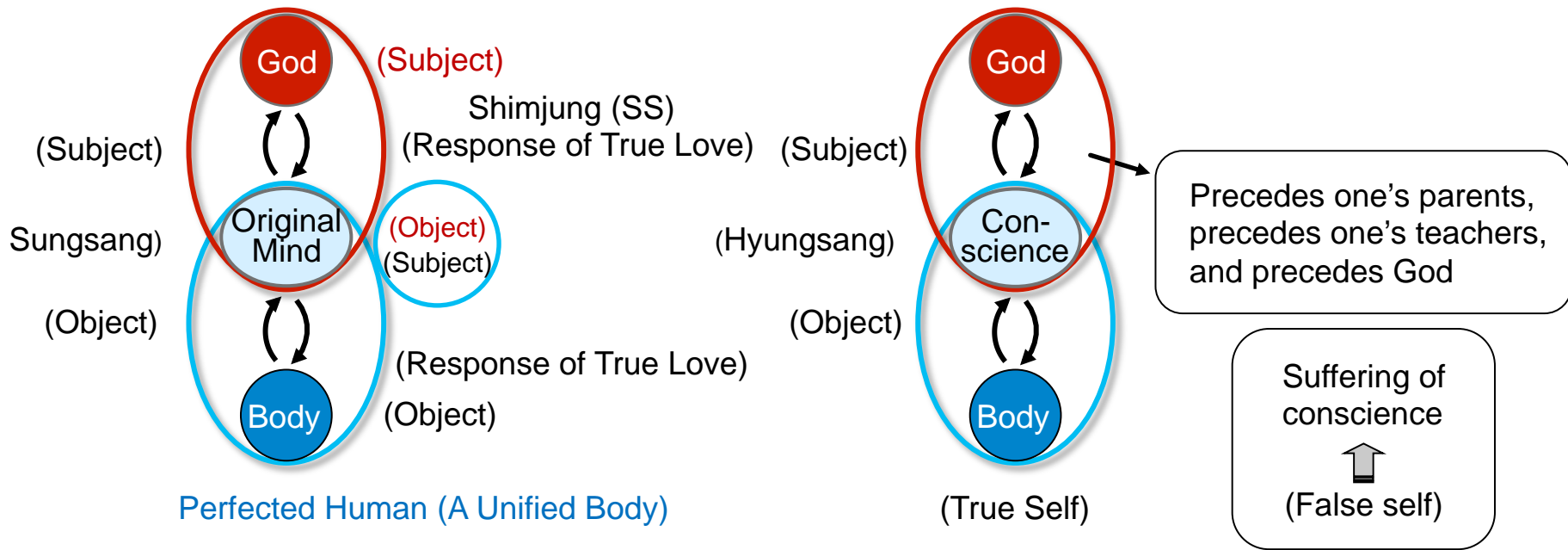

3. The Four Position Foundation

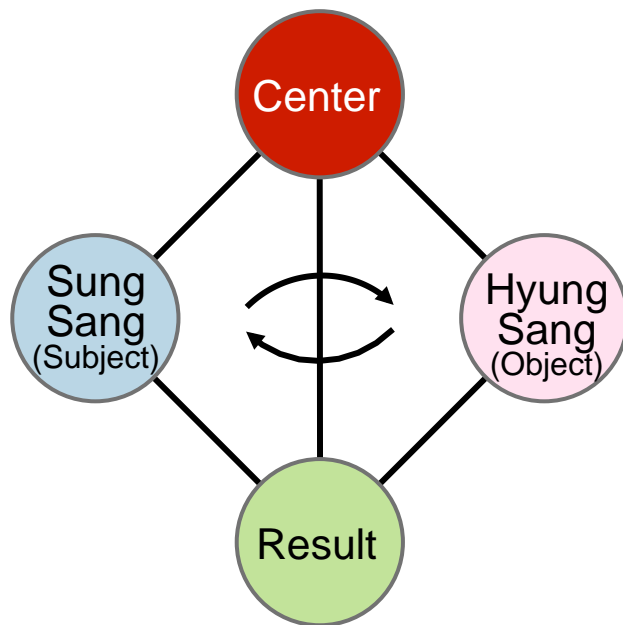

Because the give and receive action between sungsang and hyungsang is accompanied by a 'center' and a 'result', give and receive action always established these 4 positions:

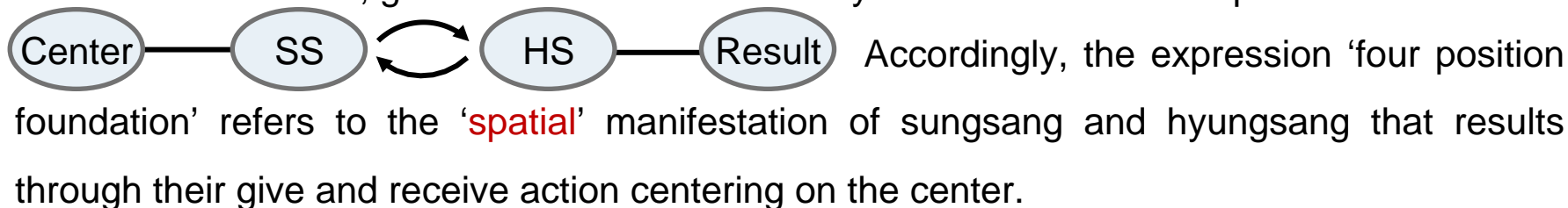

4. Origin-Division-Union Action, the Three Objects Purpose and the 4-Position Foundation

1) Origin-Division-Union Action

- i. All phenomena have both a spatial and a temporal nature. When we describe the give & receive action between the 4 elements **Center** **Subject** **Object** **Result** in **spatial** terms, we call this the 'four position foundation'. However, when we describe their give and receive action in **temporal** (time-related) terms, we call this 'Origin-Division-Union Action'.
- o 'Origin-Division-Union Action': refers to the temporal manifestation of subject and object that results through their give and receive action centering on the center.

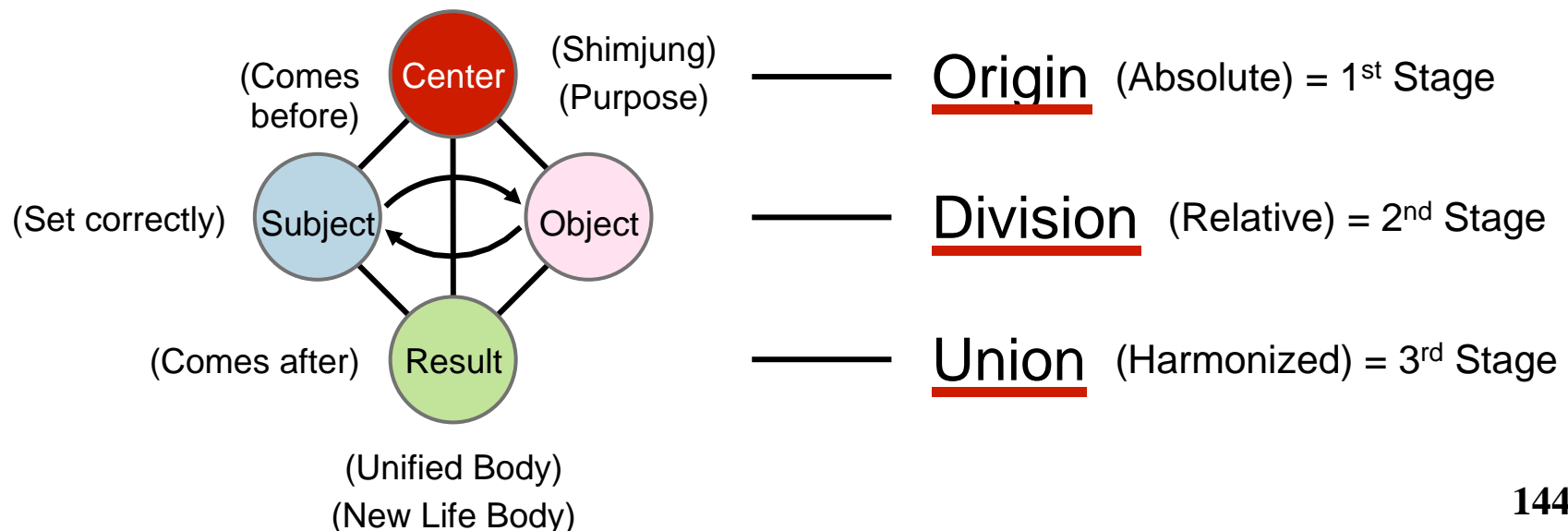

ii. Origin-Division-Union Action is the action in which God stands in the origin position and division extends from Him, with the division next being reunited again in oneness.

Satanic Theory

Arising from fallen human beings

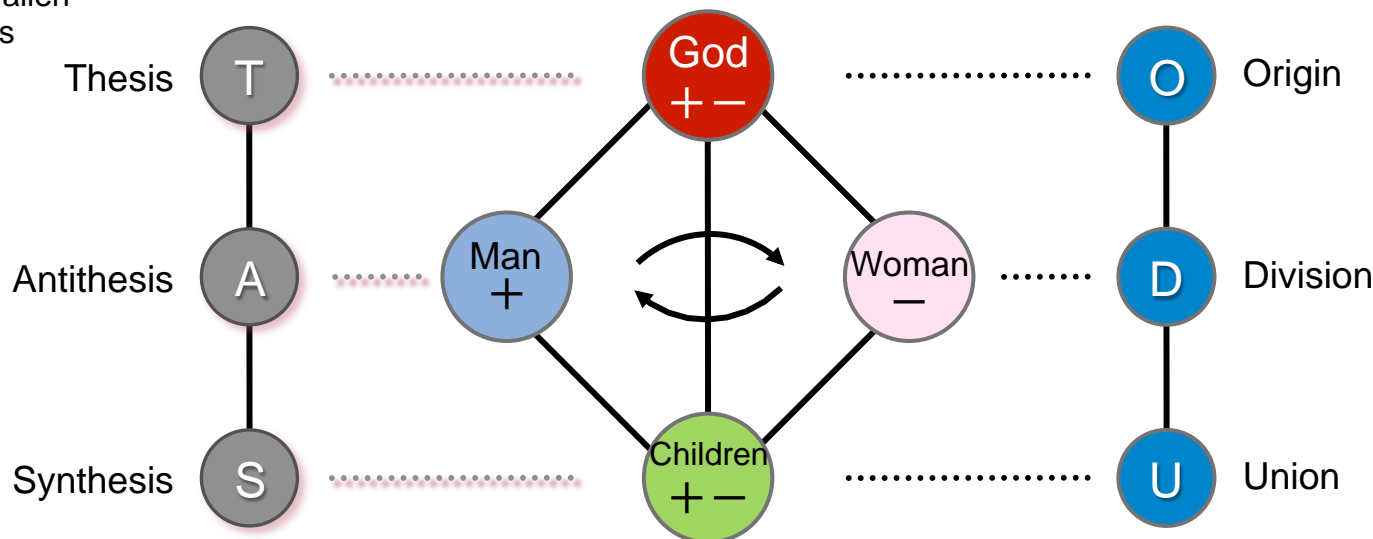

The Dialectic

Confrontation & Struggle
(Hatred)

- Dialectical Materialism -

Fusion

┌ Feuerbach's Materialism
└ Hegel's Dialectic

Law of Give and Receive

Give and Receive Action
(Love)

- Give and Receive-type One-ism -

Development thru 3 Stages

iii. Relationship between ODU Action and Dialectical Materialism

When Marx and Engels combined Hegel's dialectic with materialism, they created 'Dialectical Materialism'. Hegel's dialectic is a development logic that adopts the formula:



- The **Thesis** **Antithesis** **Synthesis** formula within dialectical materialism is a formula for development through contradiction, wherein all things develop through the unity and struggle of the “conflicting parties”, namely the ‘thesis’ (A) and the ‘antithesis’ (B).
- In reality, Communists ignore the **Unity** aspect and only view development through **Struggle** as being dialectical development.
- In fact, any thing or being only develops when subject and object achieve harmonious give and receive action centering on a common purpose.

iv. Dialectical Materialism and Reciprocal One-ism

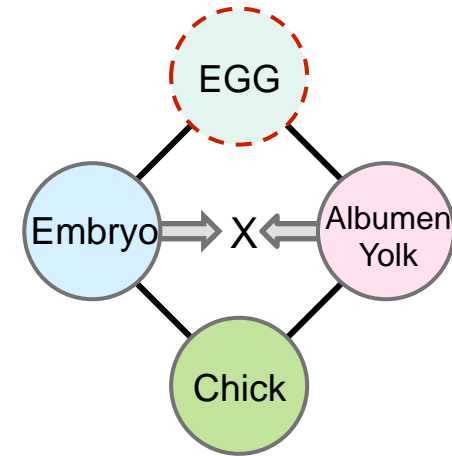
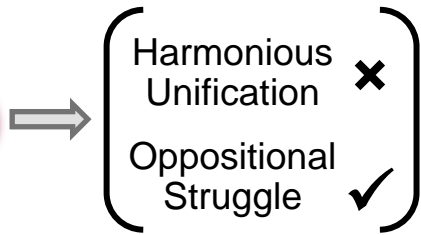
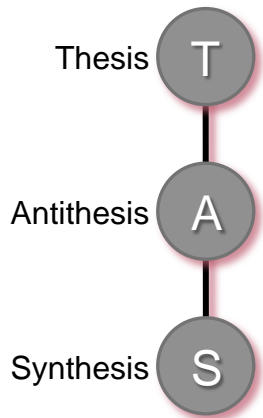

(Dialectical Materialism)
(Thesis-Antithesis-Synthesis)

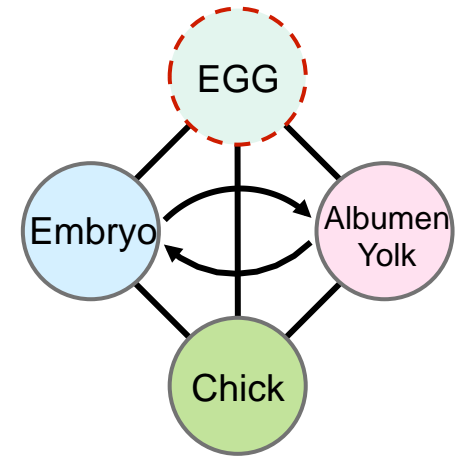

(Give & Receive One-ism)
(Origin-Division-Union)

Conclusion

(Dialectical Materialism)

Opposition & Struggle =
Destruction

(Give & Receive One-ism)

Harmonious Unification =
Development

- ❖ When an embryo and the egg's albumen / yolk stand in the positions of subject and object partners and both are directed towards the same purpose, it is more appropriate to call this a give and receive relationship, rather than a dialectical relationship.

Accordingly, this dynamic should be considered one of give and receive-type (reciprocal) One-ism (sungsang / hyungsang), rather than dialectical materialism.

- ❖ The 'Three Element Nature' of Individual Truth Bodies

All created beings necessarily possess three types of relative subject/object elements:

Sungsang & Hyungsang
(Int. Char. & Ext. Form)

Yang Nature &
Yin Nature

Main Element &
Supporting Element

2) The Three Objects Purpose

When any one of the four elements assumes the position of subject, the other elements take the position of its three objects.

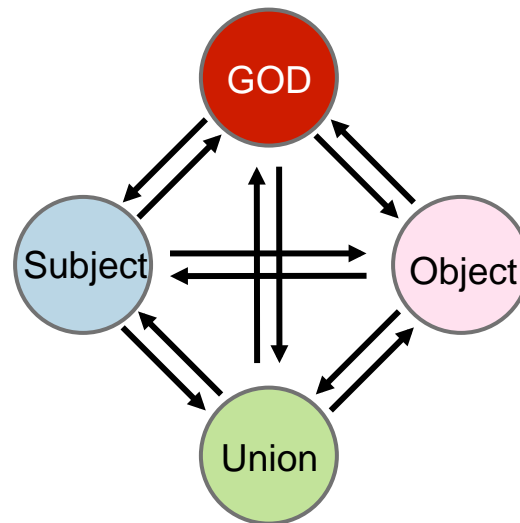

- i. When all four elements engage in Give and Receive Action, the **Three Objects Purpose** is perfected and completed.
- ii. The **center of all beings** is **God**.
- iii. All **motivation** begins from **God**.
The self should not be the center of motivation.

3) The Four Position Foundation

(1) When the 4 elements engage in Give and Receive Action and the Three Objects Purpose is perfected and completed, the Four Position Foundation is formed.

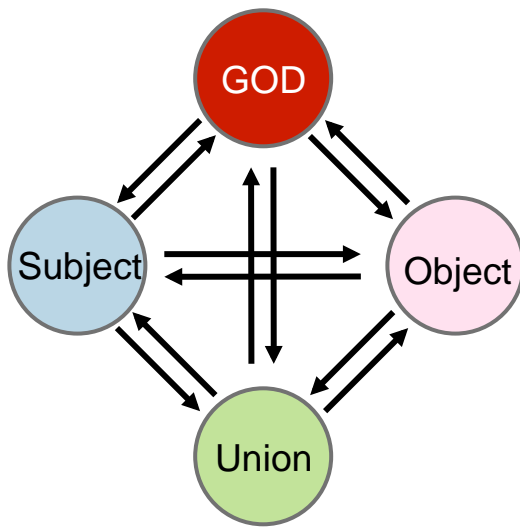

- i. Foundation for the completion of God's purpose of creation
- ii. Foundation for existence
- iii. Fundamental foundation of love
- iv. Fundamental foundation of goodness
- v. Fundamental foundation of power (energy)
- vi. Fundamental foundation for 3 stages
- vii. Fundamental foundation for the numbers 4, 3 and 12

(2) Types of Four Position Foundation

i. Individual Four Position Foundation

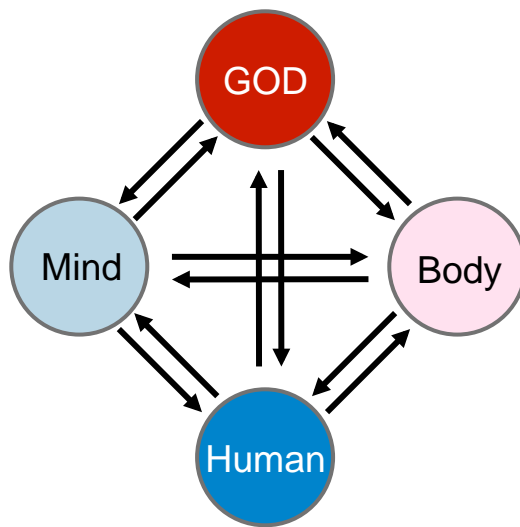

Individual Perfection/
completion
(perfection of character)

ii. Family-type Four Position Foundation

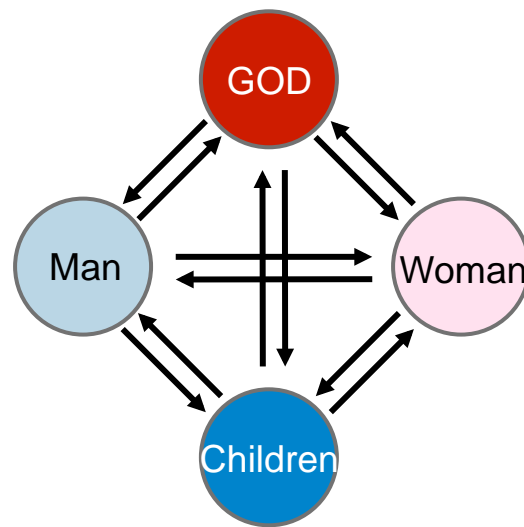

Family Perfection/
completion
(ideal family)

iii. Dominion-type Four Position Foundation

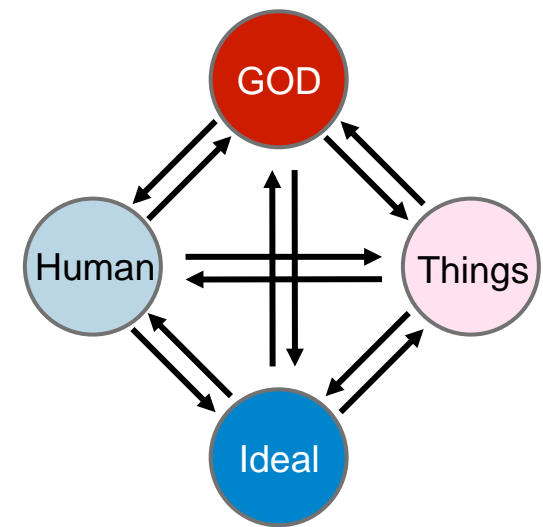

Perfection/completion
Of Mastery (Dominion)
(ideal world)

(3) The Mode of Existence of the Four Position Foundation

Circular Motion

Spherical Motion

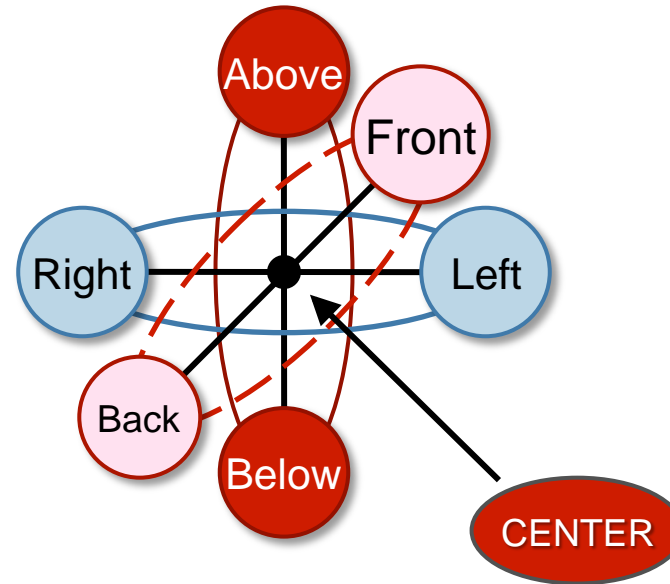

Standard of Absolute Values: God

Absolute Values: True Love, True Life, True Lineage, Absolute Sex

The Privileges of True Love:

Right of Equal Status, Right to Live Together, Right of Participation

→ The Right of Inheritance

4) The Omnipresence of God

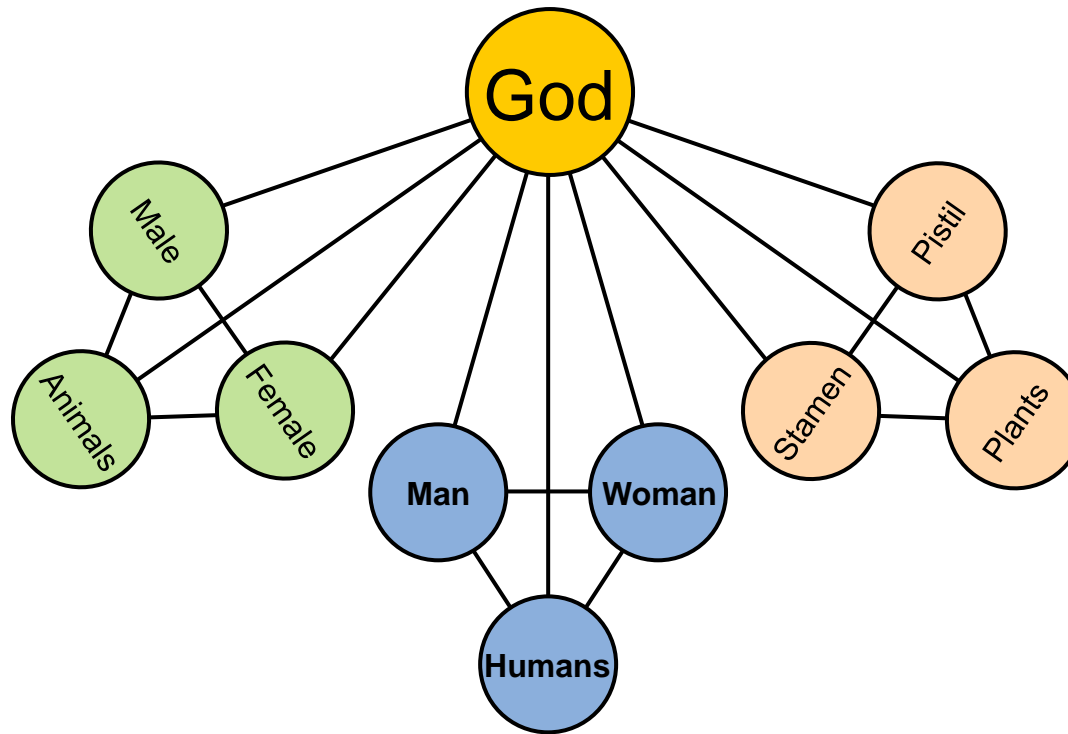

In the world where God's purpose of creation has been completed, all individual beings embody God's original internal nature (original *sungsang*) and original external form (original *hyungsang*), giving rise to spherical motion and forming the basic foundation for God's governance and action.

In this way, God becomes universally present in all created things.

5) The Multiplication of Life

Without exception, for living beings to continue to exist, they must reproduce. This multiplication takes place through the Origin-Division-Union action that results from Give and Receive Action.

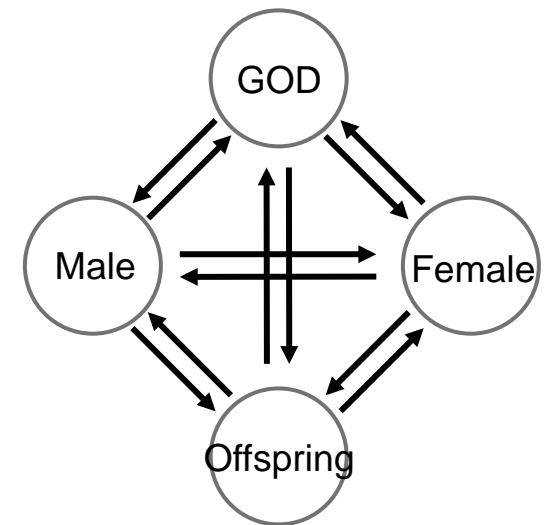
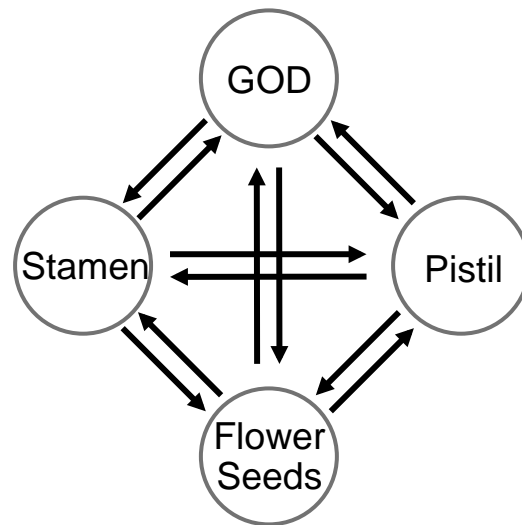
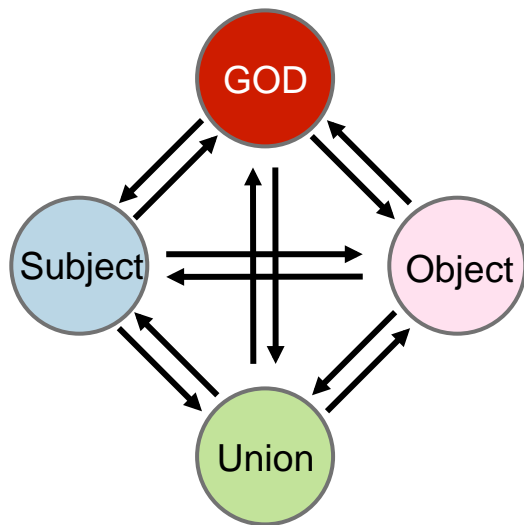

6) The Reason all Beings are Comprised of Dual Characteristics

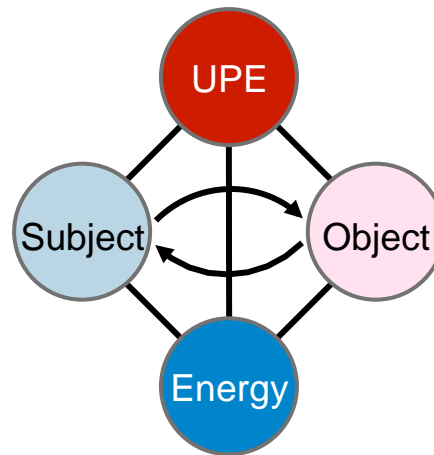

- 1) For the sake of existence
 - i. Energy is necessary for existence.
 - ii. Energy comes from Give and Receive Action.
 - iii. Give and Receive Action requires a partner, a counterpart.

- 2) For the sake of perpetuity

III. The Purpose of Creation

1. The Purpose and Motivation for Creation

(1) The Motivation for Creation

Shim Jung

- God's essential attribute
- The root of God's true love
- The core of God's character

Joy ↔ Love

Object

The *Shimjung* Impulse
The irrepressible emotional impulse to experience joy in loving one's object

No Form

Substantial

(Momentary)

(Eternal)

(2) The Purpose of Creation

Joy

Object

- i. Object who resembles (Gen 1:27)
- ii. Object that is good (John 14:20)
- iii. Perfect & complete object (Matt 5:48)[†]
- iv. Object of Shimjung (Gen 1:28)

2. An Object of Goodness for the Sake of God's Joy

1) **God's Governance = 4 Position Foundation**
God's Joy = 4 Position Foundation

Gen 1:28
 (The Three Blessings)

First Blessing (Be Fruitful)

(Individual Completion = Perfection of Character)

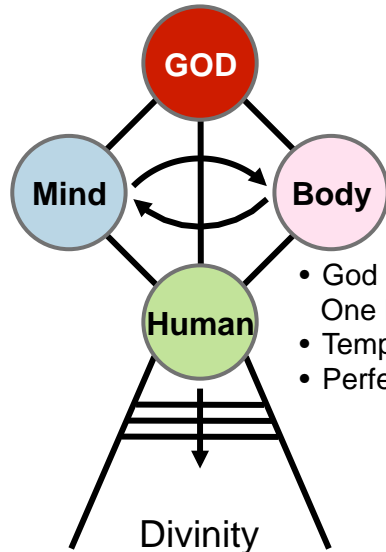

- God & Human = One Body (John 14:20)
- Temple (1 Cor 3:16)[†]
- Perfect (Matt 5:48)[†]

Heavenly People
 Shimjung, Abs. Sex
 (Shimjung Education)

Second Blessing (Multiply)

(Family Perfection = Ideal Family)

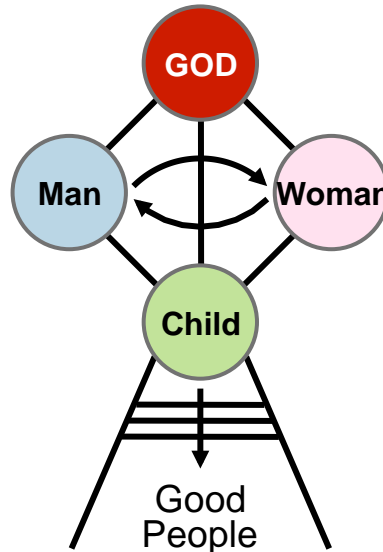

World of Goodness
 Heaven Life
 (Education of Norms)

Third Blessing (Have Dominion)

(Perfection of Dominion = Ideal World)

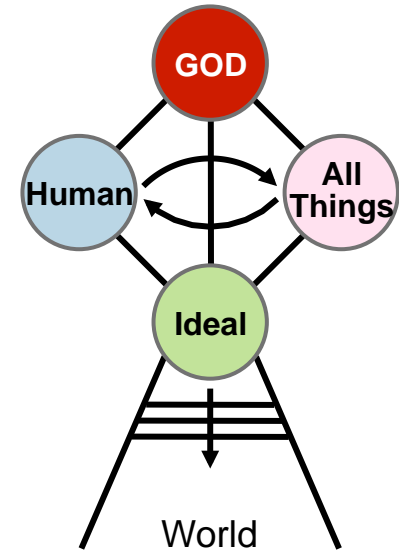

K. of Heaven in SW & PW
 Cheon Il Guk
 (Education of Skills, Knowledge, Physical Ed.)

2) The Greatest of the Three Blessings = The Blessing of Marriage

(Inheritance of God's True Love, True Life, True Lineage and Absolute Sex)

Absolute Sex → Completion of the Realm of Liberation thru the Portion of Responsibility

3) Explanation - The Three Blessings

(1) Individual 4 Position Foundation

(Individual Completion = Perfection of Character)

Individual Perfection	$\left\{ \begin{array}{l} \bullet \text{ God \& Human = One} \\ \text{Body (John 14:20)} \\ \bullet \text{ Temple (1 Cor 3:16)}^{\uparrow} \\ \bullet \text{ Perfect (Matt 5:48)}^{\uparrow} \end{array} \right\}$	Shimjung Education (Absolute Sex – Purity – Fidelity)
----------------------------------	--	---

(2) Family-type 4 Position Foundation

(Family Completion = Ideal Family)

i. Education for

Completion of Family

- Education on qualifications for couples
- Education on keeping God's commandment

ii. Education for becoming

Principled Beings

- Education on putting love into practice and ethical lifestyle
- Education on living according to Heavenly Fortune

(3) Dominion-type 4 Position Foundation

(Perfection/Completion of Mastery = Ideal World)

- Education for the **Perfection/Completion of Mastery**
〔 Knowledge Education, Skills Education, Physical Education 〕

3. God's Creation Ideal (Purpose) & the Family-type Four Position Foundation

God's Purpose of creation is the realization of true love.

The basis for the realization of God's true love is the family-type four position foundation.

God's true love appears through divisible love.

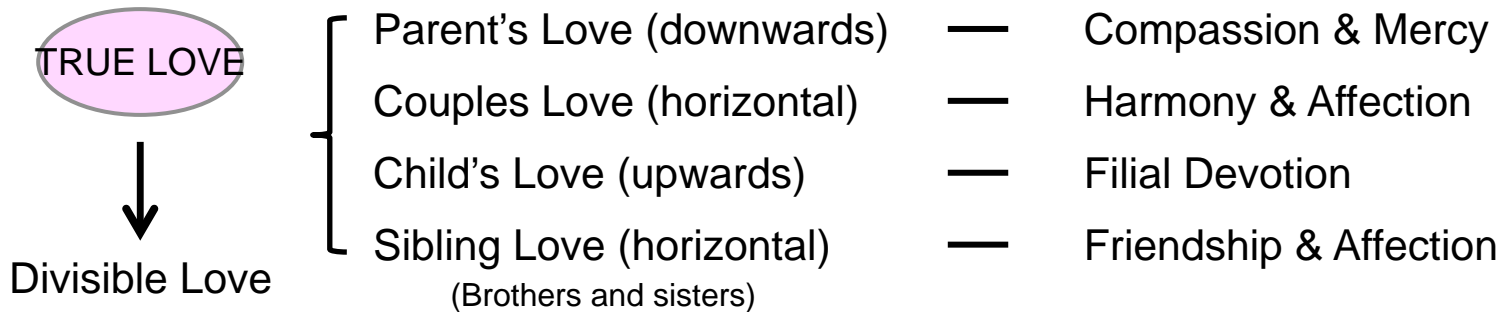

1) Morals and Ethics

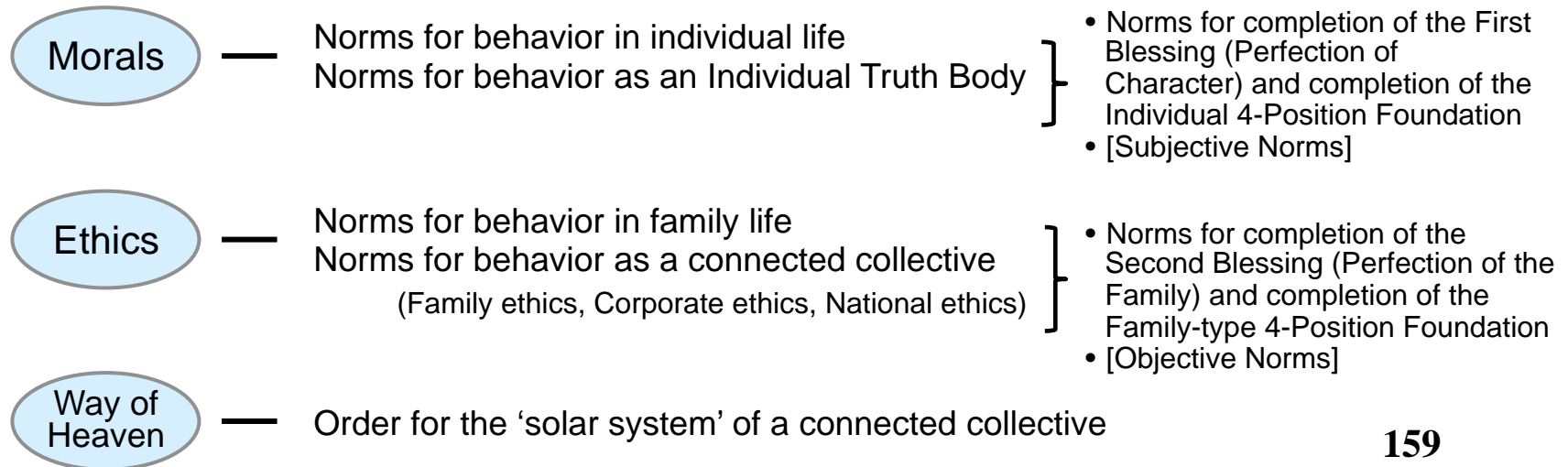

2) Vertical and Horizontal Order within the Family

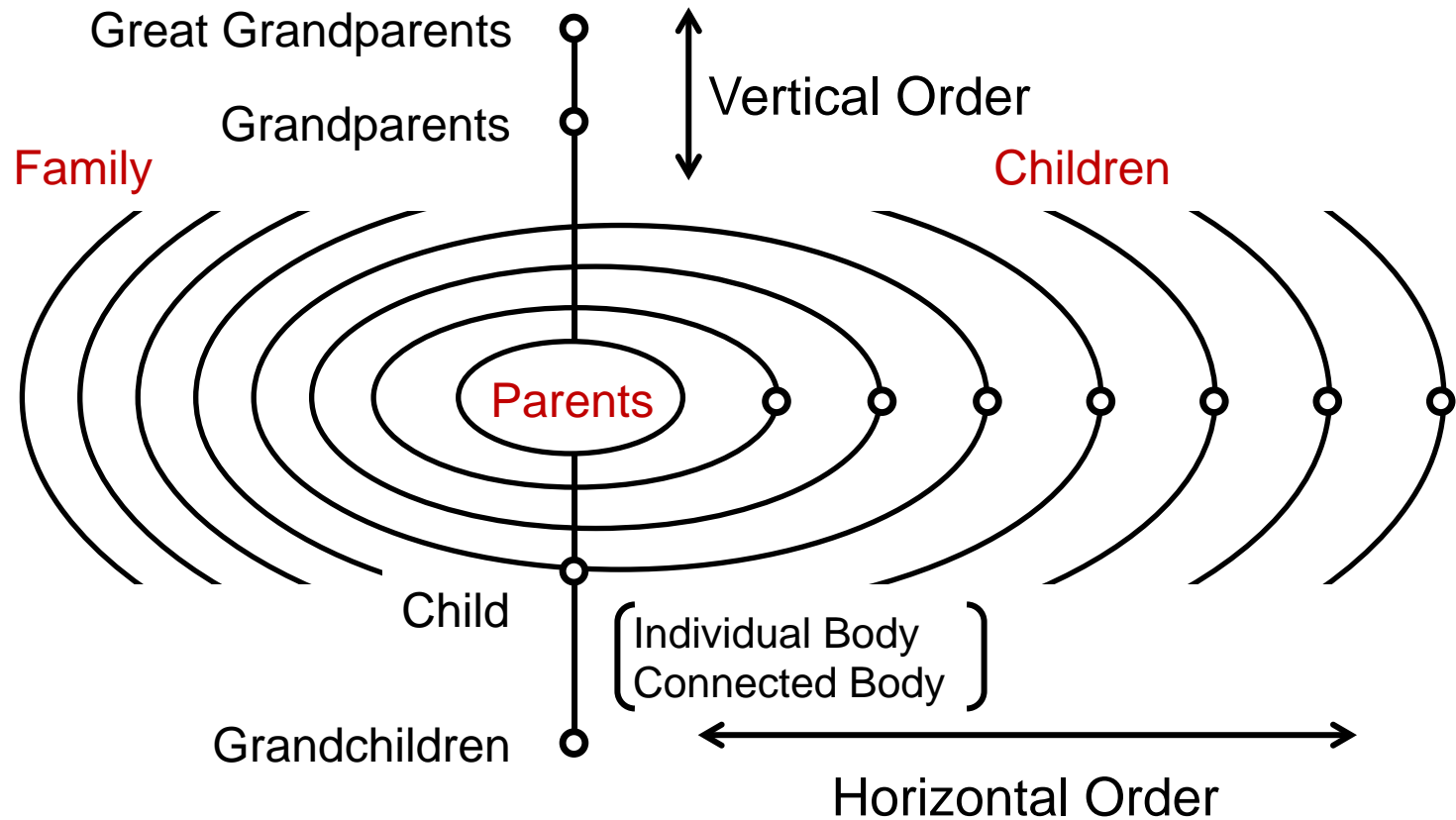

- The Family as a Connected Body -
(Family Ethics)

3) Vertical and Horizontal Order in The Universe

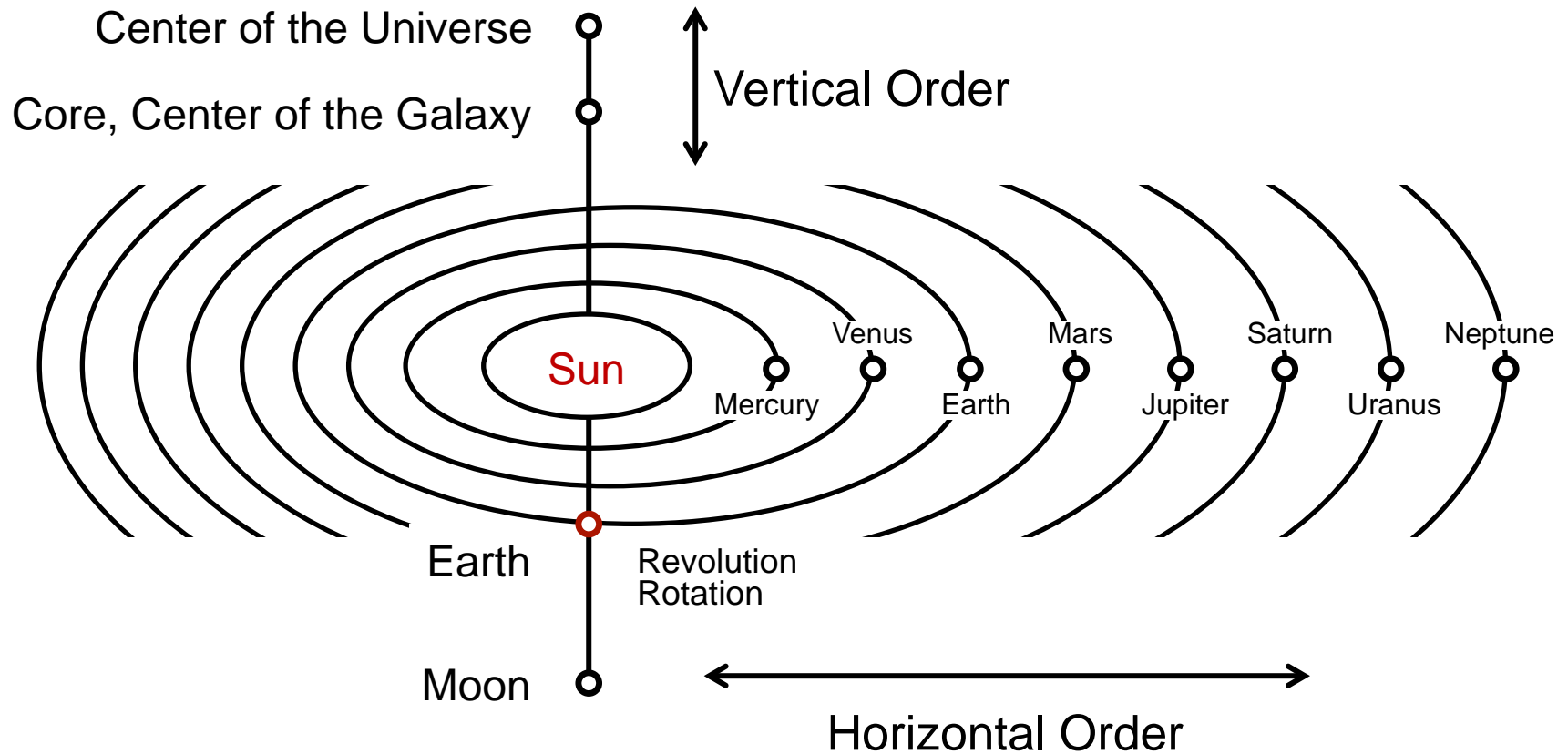

- The Solar System as a Connected Body -
(Family Ethics)

4) True Love Equality is Equality through Order

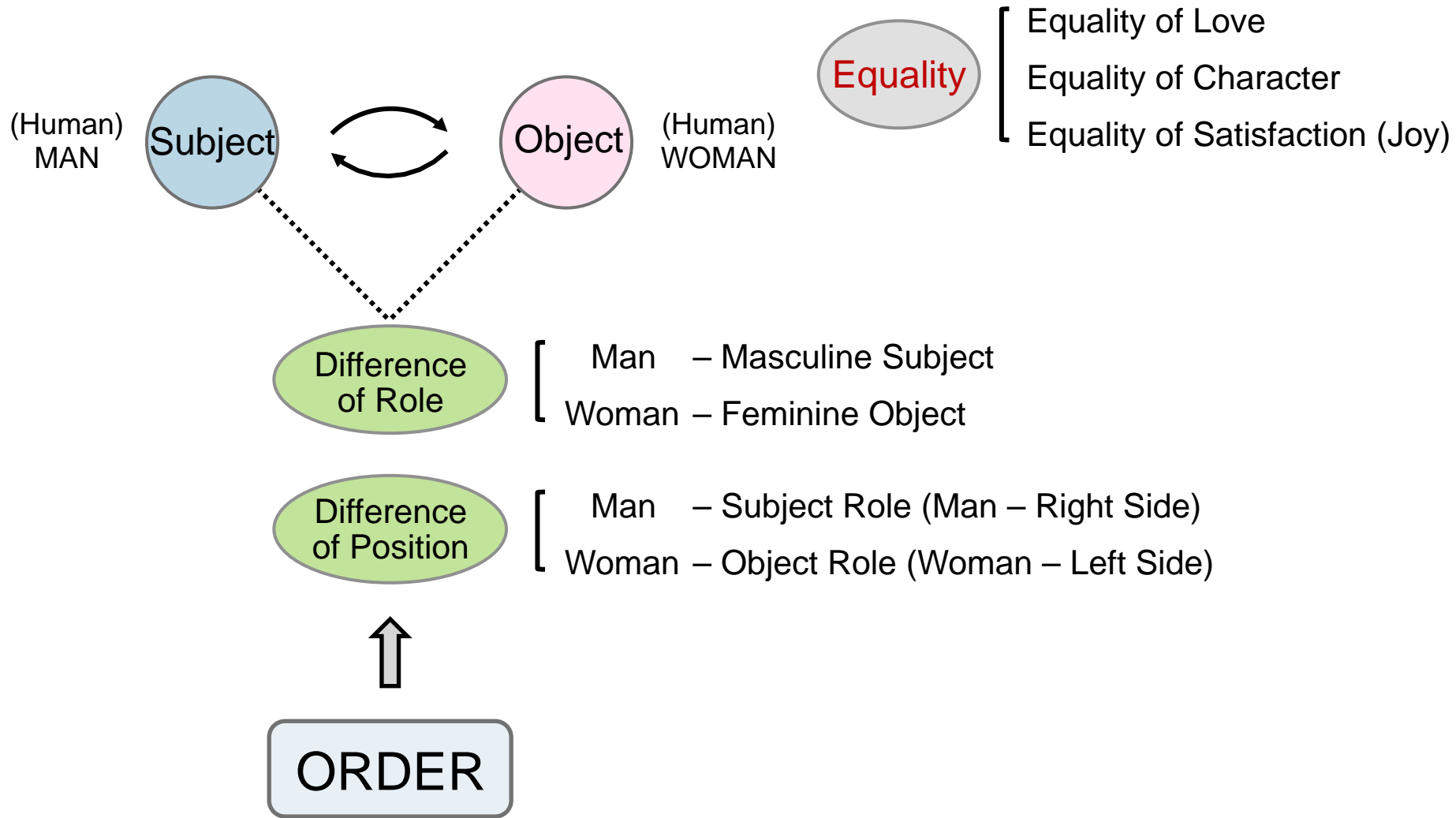

5) The Privileges of True Love

Right of participation, Right of Equal Status, Right to Live Together



Right of Inheritance

True Love is: Investing and forgetting and not remembering
Giving and forgetting and wanting to give more
Living for the sake of others

The source and origin of True Love is God. Where there is no true love, God also is not present.

6) What is True Love?

- The Source of Life
- The Source of Happiness
- The Source of Peace
- The Source of Unity
- The Source of Joy
- The Source of True Lineage

Absolute Sex Purity Movement and Peace Movement centering on True Love

If true love has not borne fruit, it will remain unfertilized even if it is planted.

(Selected Speeches Vol. 608 p. 48, Feb. 18, 2009)

7) The Family is the Basic Unit of Heaven.

- (1) Constituent Members: Parents – Couple – Children (Siblings)
- (2) Relational Nature (Above & Below – Right & Left – Front & Back)

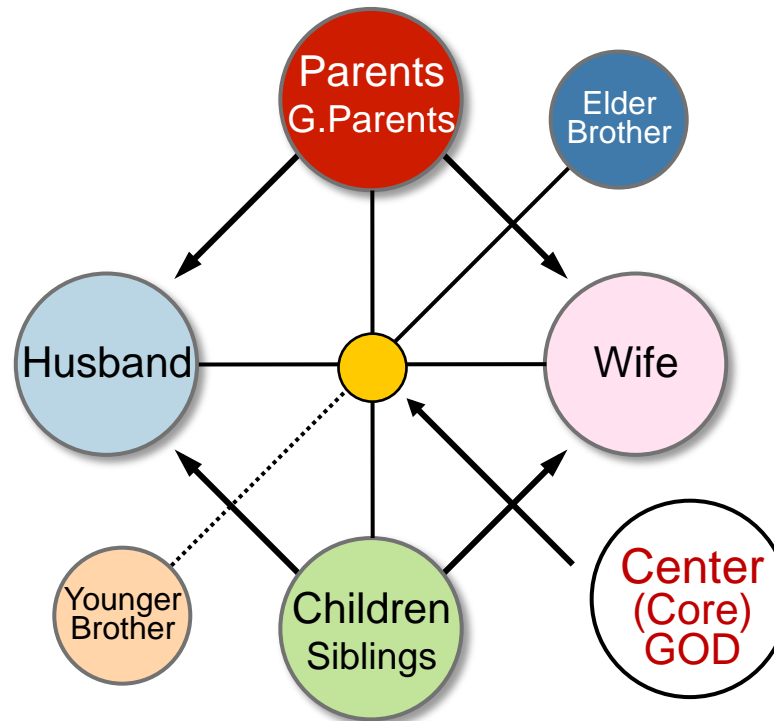

- (3) Relationally One Body (Unified body)



iv. The order of the family is the standard for the order of the universe.

v. The family is God's ideal of creation.



4. Dual Purposes

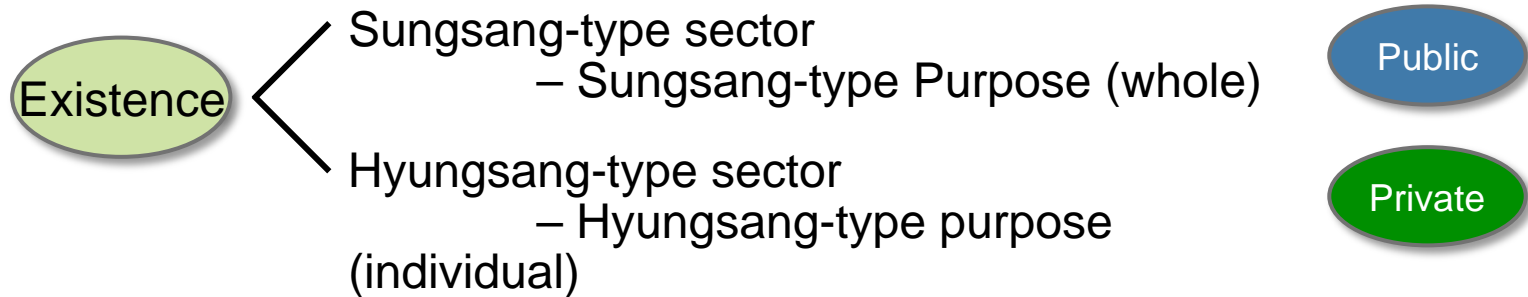

A Connected, Organic Body

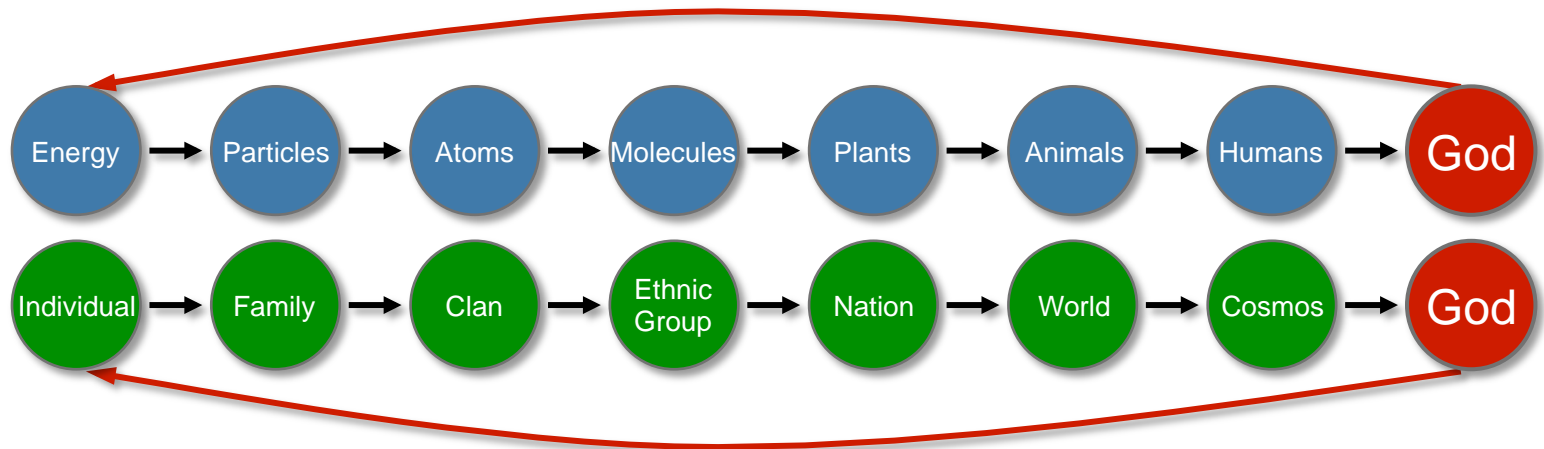

5. The Four Great Realms of *Shimjung* (Heart) and the Three Great Kingships

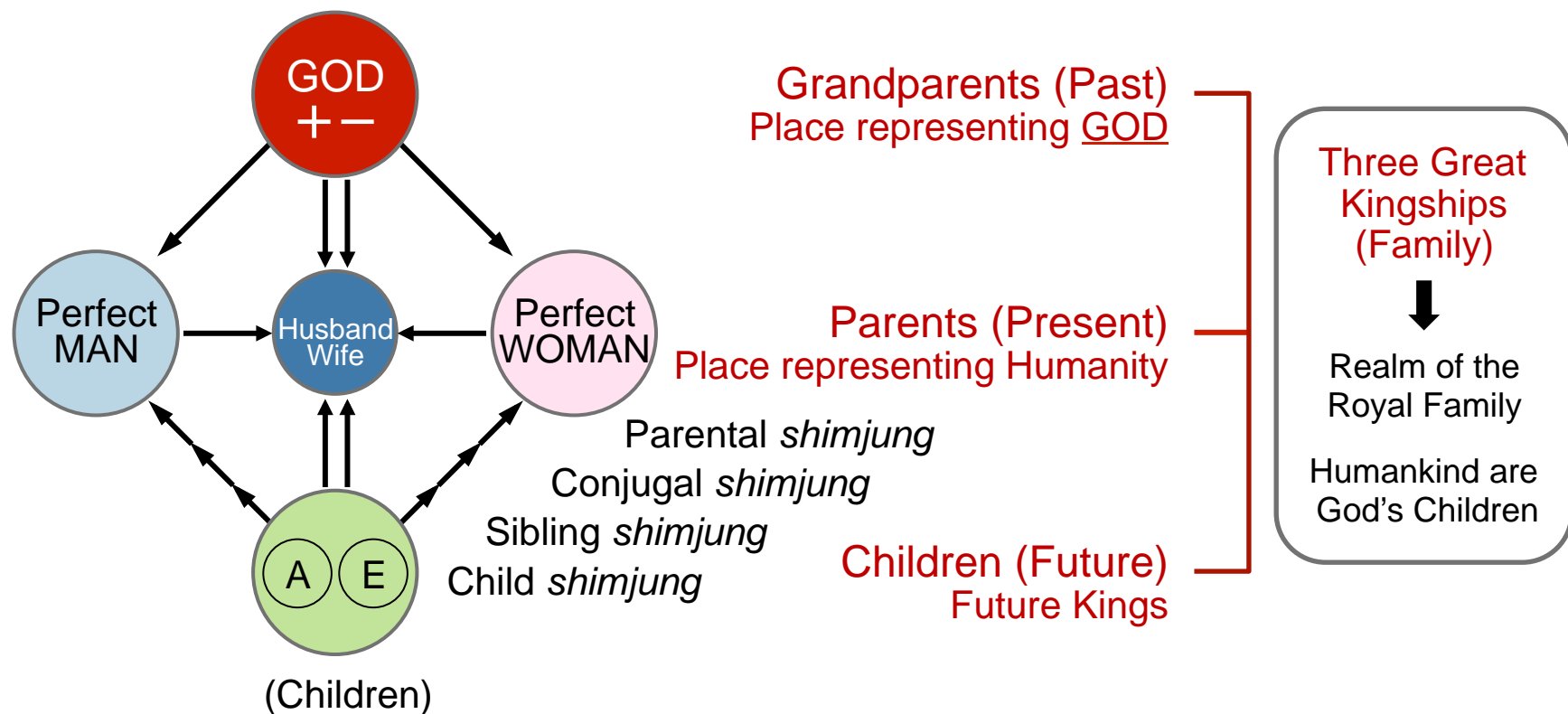

1) What is the reason for marriage?

1) In order to be complete, perfect and whole (prior to marriage, only half)

- i. To resemble God, who is complete, perfect and whole
- ii. To capture and occupy the true love of God
- iii. To complete and perfect love (perfect one's self)
- iv. Thus, the owner of your sexual organ is your partner, your counterpart (love is experienced and completed through one's counterpart).

2) To perfect God and perfect love's realm of liberation

Adam and Eve's Marriage : [God's Marriage
 || Substantial Incarnation of God

First Love : [God's First Love
 Point of Union b/n God's love and Human love
 → The Sexual Organs

3) In order to multiply God's True Love, True Life and True Lineage (eternally)

Conclusion: The Purpose for Creating Human beings [God's Body (for God to use a body)
 Object of Love (in order to experience substantial love)
 Multiply the Children of God (in order to multiply children)

2) The Principle View of Marriage

(1) Marriage for the Sake of One's Counterpart

Why? The true path of human life is the path of existing for sake of the other, being born for the sake of others, growing for the sake of others, getting marriage for the sake of the other, living for the sake of others, and heading towards the world of living for others by helping each other to achieve completion and perfection. The world of living for others is the ideal world, the Kingdom of Heaven. Thus, the basic unit of the Kingdom of Heaven is the family.

(2) An Ideal Husband and Wife are Unchangeable.

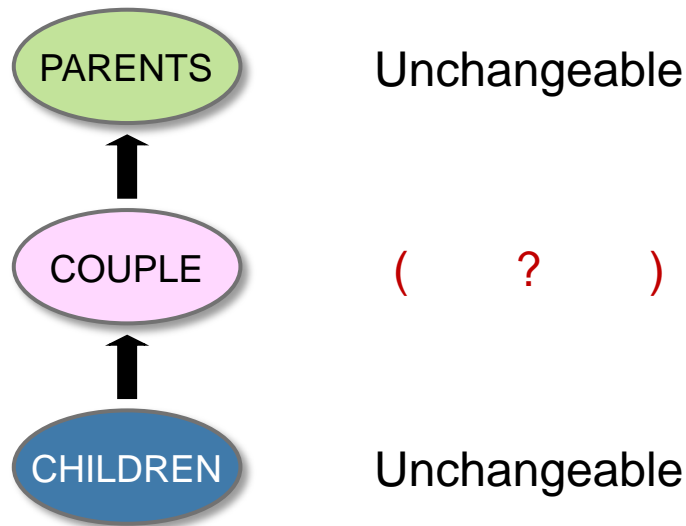

3) Completion of the True Family Ideal

(1) Completion of Husband/Wife Ideal (Completion of the Parental Ideal)

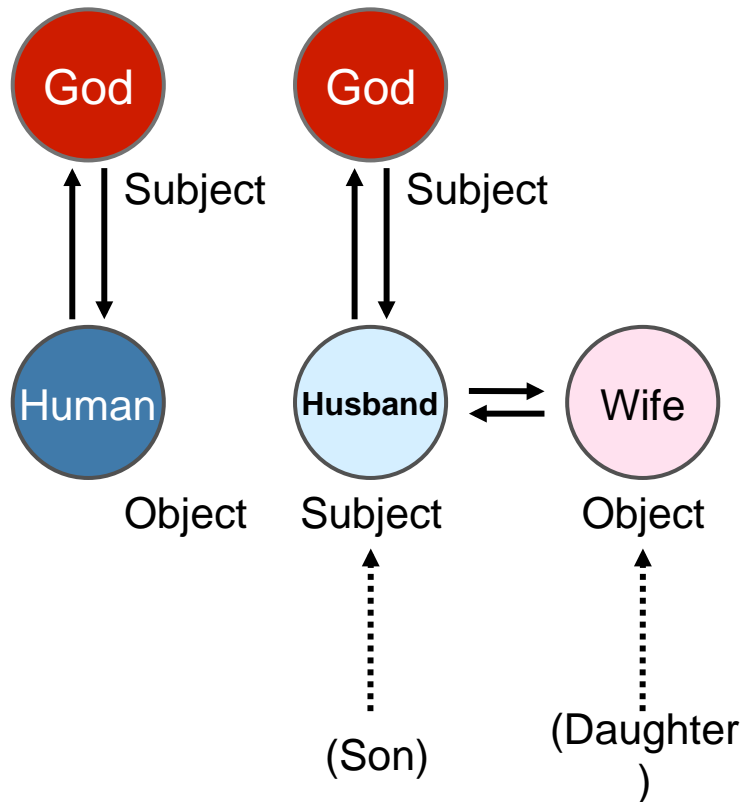

- i. The husband in the subject position unites with God, his subject, and brings completion to his object, the wife.
- ii. The wife in the object position unites with her husband, her subject, and brings completion to her subject, the husband.
- iii. The husband and wife were born as a son and a daughter. They both grow and complete themselves by attending their parents.
- iv. Accordingly, the husband attends his wife as he would attend his mother and the wife attends her husband as she would attend her father. Together, they both bring completion to each other by living for each other in daily life.
- v. In this way, they become a true couple resembling God, who is complete and perfect, eventually becoming complete and perfected true parents.

(2) Completion of Sibling Ideal (Completion of the Child Ideal)

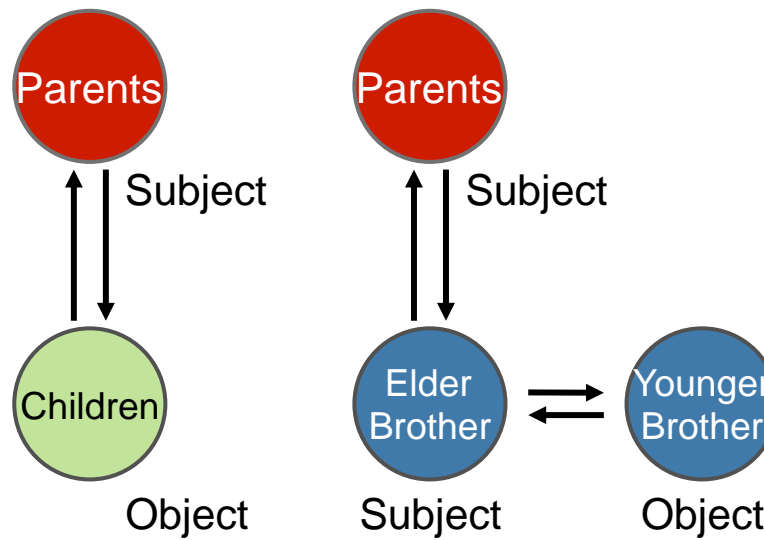

- i. The elder brother in the subject position unites with his parents, the subject, and brings completion to his object, the younger brother.
- ii. The younger brother in the object position unites with his elder brother, his subject, and brings completion to his subject, the elder brother.
- iii. The elder and younger brothers were born as second selves of the parents.
- iv. Accordingly, the elder brother attends his younger brother as he would attend his parents and the younger brother attends his elder brother as he would attend his parents. Together, they both bring completion to each other by living for each other in daily life.
- v. In this way, they become true children resembling their true parents, eventually becoming true brothers.

IV. Determination of the Original Value of Creation & the Standard for that Value

1. Definition of Value

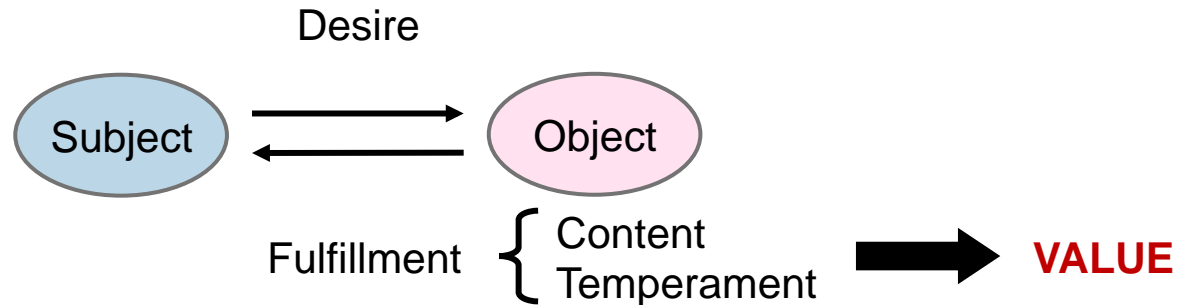

2. Determination of Value

(1) Value Determination from the Perspective of Purpose

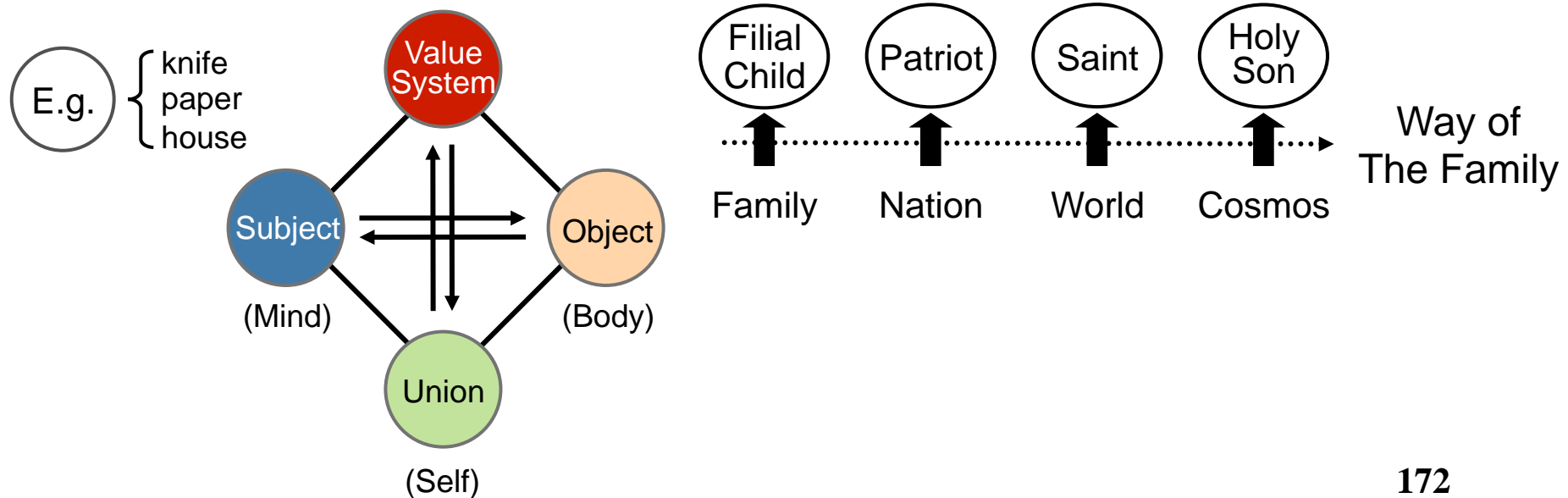

(2) Determining Original Creation Value

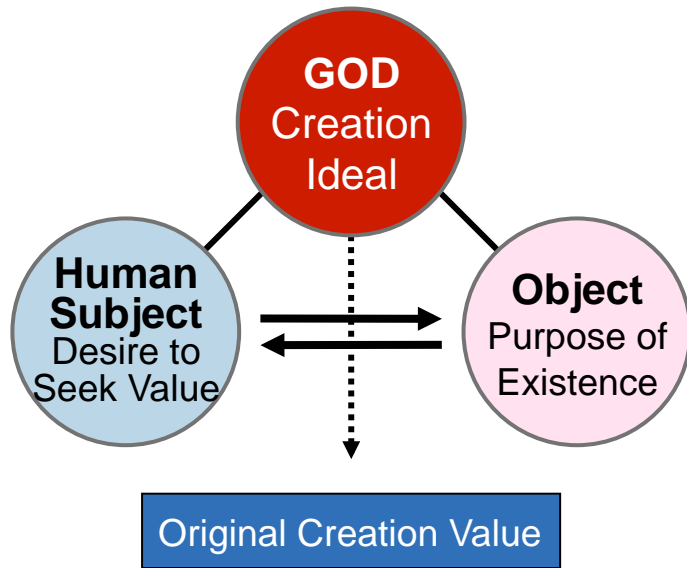

The original creation value of an individual entity is determined by the relative reciprocal relationship between a) the purpose of the entity as an object according to the ideal of God's creation and b) the desire of a human subject to pursue its original creation value when relating to the entity.

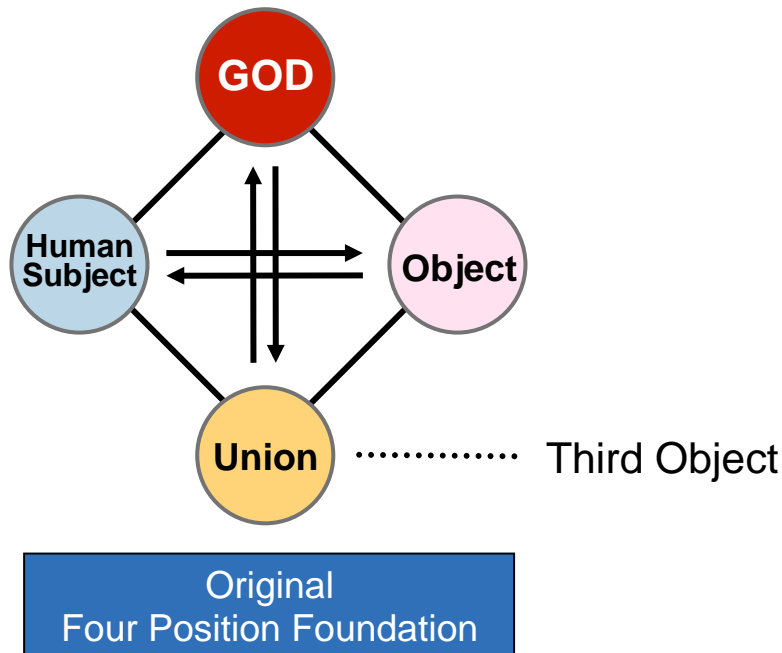

Hence, in order for an object to realize its original creation value, it must become one in a union with a human subject through give and receive action, thereby establishing an original Four Position Foundation in which it forms part of a third object to God.

3. The Standard for Original Creation Value

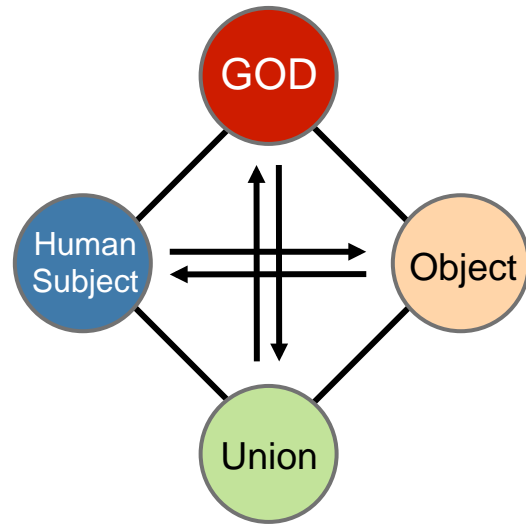

Since the center of the four position foundation is God, who is absolute, God himself sets the standard of its value. Since God is absolute, and the original creation value of an object is determined in relation to God, the original creation value of that object is also absolute.

(1) The Standard of Value = Absolute, Unique, Unchanging and Eternal

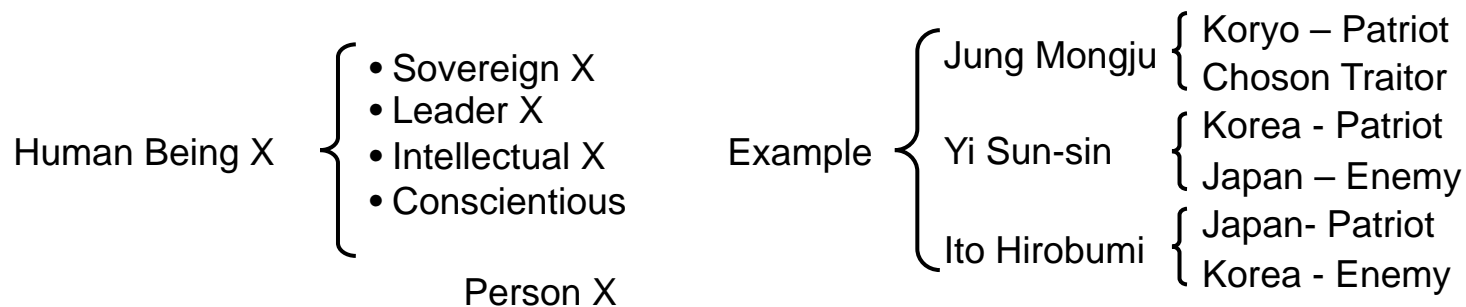

(2) Thus, the Standard of Original Creation Value = God (the True Parent)

4. The Value of a Human Being in the Original Creation

- Divine Value
- Eternal Value
- Unique and Irreplaceable Value
- Cosmic Value

5. Emotion, Intellect and Will & Beauty, Truth and Goodness in the Original Creation

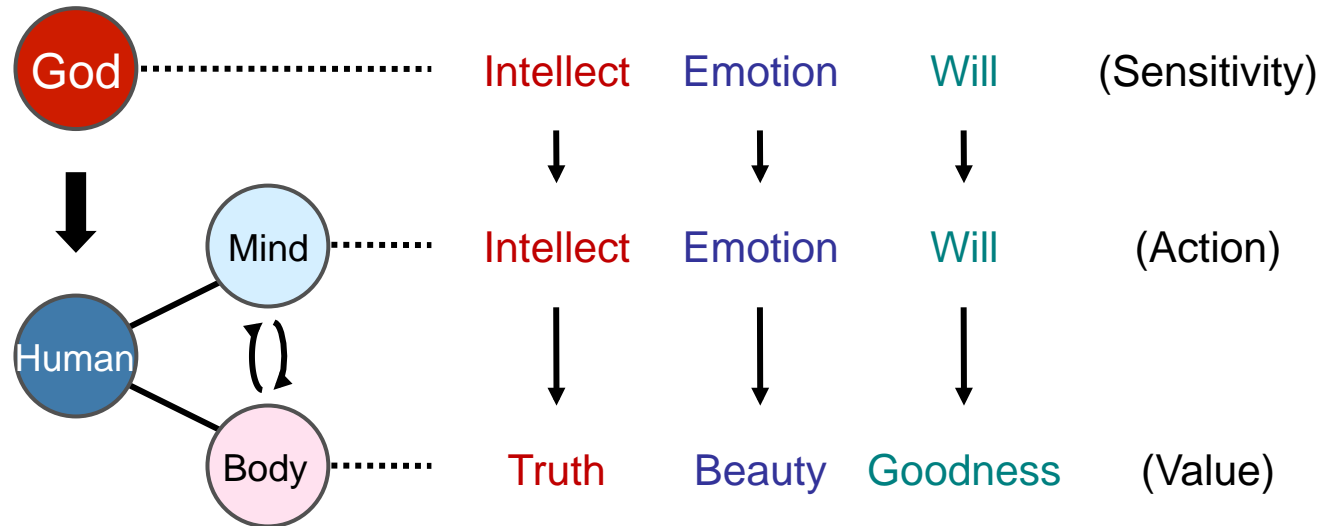

The human mind has three faculties: Intellect, emotion and will.

The human body is substantially sensitive to the human mind, that is, to human intellect, emotion and will, and as such, the actions of the body manifest as the pursuit of the values of truth, beauty and goodness.

6. Love & Beauty, Good & Evil, Righteousness & Unrighteousness

1) Love and Beauty

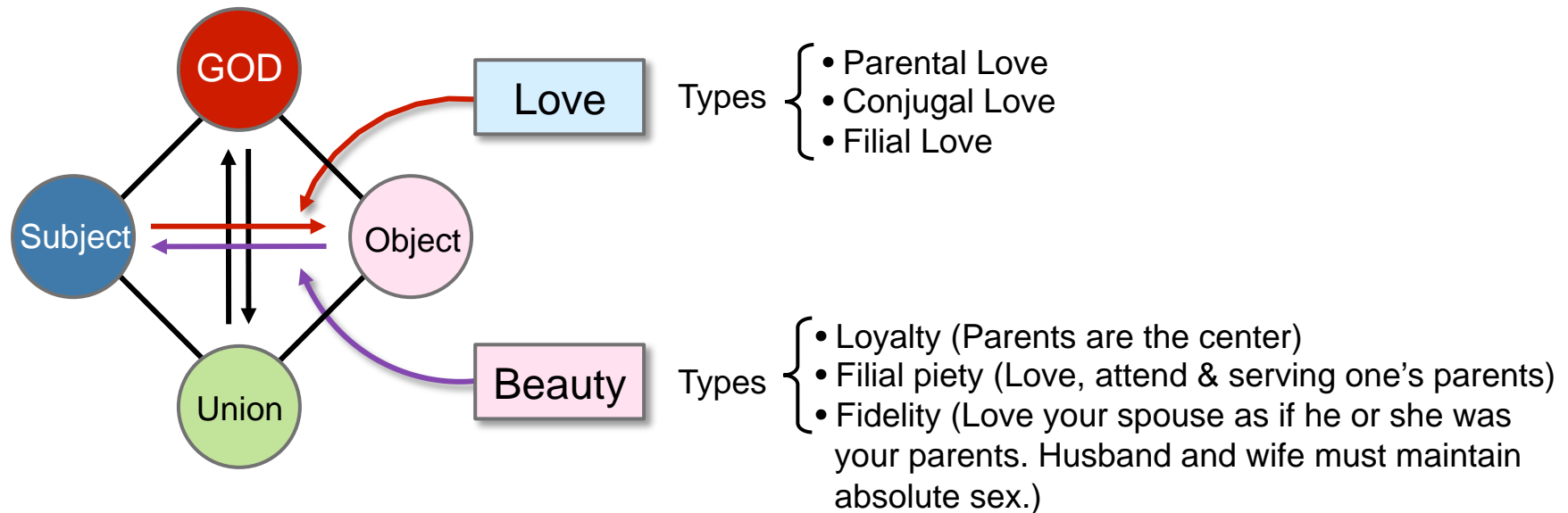

When two entities have been divided as substantial manifestations of God's dual characteristics, they will seek to establish a four position foundation by forming a common base and engaging in give and receive action. They will do this in order to come together as a unified body, a third object to God. In this process, the emotional force that the subject gives to the object is what we call love, and the emotional force that the object gives to the subject is what we call beauty.

The force of Love is an active force and the response of Beauty is a passive force.

2) Good and Evil

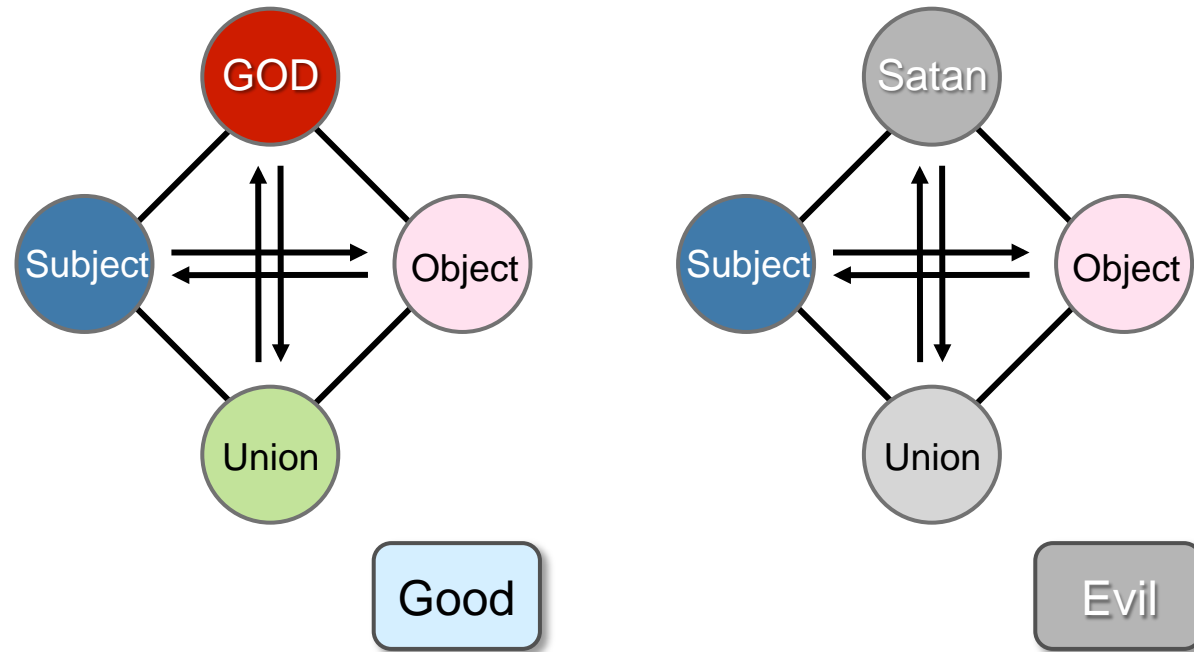

Any action, or result of an action, is 'good' when a subject and object fulfill the purpose of God's creation by a) giving : receiving love and beauty to b) form a unified body and c) become a third object to God as a result, thereby d) establishing a four position foundation.

An action or result of an action is 'evil' when a subject and object fulfill Satan's evil purpose by forming a four position foundation centering on Satan.

3) Righteousness and Unrighteousness

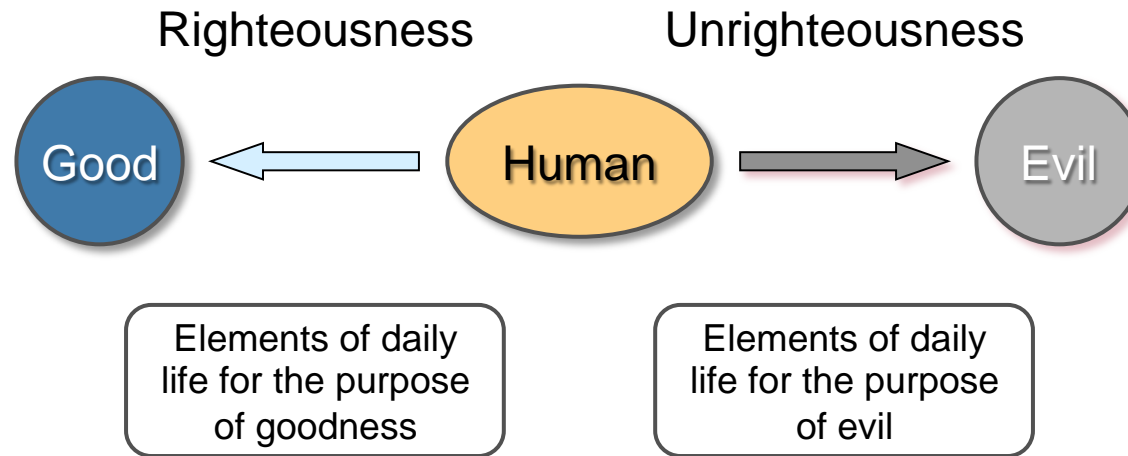

In the process of accomplishing the purpose of goodness, the elements of daily life that are directed towards that goodness are what we call 'righteousness'.

In the process of fulfilling Satan's purpose (evil), the elements of daily life that are directed towards that evil are what we call 'unrighteousness'.

V. The Creation Process for God's Creation and the Growing Period for Created Beings

1. The Creation Process for God's Creation

	Day 1	Day 2	Day 3	Day 4	Day 5	Day 6
Bible Gen 1:1-31	Light Darkness	Firmament Waters above Waters below	Oceans Land Plants	Sun Moon Stars	Fish Fowl	Mammals Human Beings
Science	Non-liquid Era (Gas)	Liquid Era	Oceans Continents	Plants	Animals	Human Beings
	Azoic Era	Archeozoic Era	Proterozoic Era	Paleozoic Era	Mesozoic Era	Cenozoic Era

Biblical Revelation

6 Days : Period of Creation → Refers to 6 stages in the
Process of Creation

1 Day ≠ 24 hours (II Peter 3:8)

2. The Growing Period for Created Beings

❖ Evidence for the Existence of a Growing Period

- i. The Process of Creation (6 days)
- ii. The Human Fall (Fall could not take place after complete perfection)
- iii. God's assignment of a human portion of responsibility (incomplete and unperfected)
- iv. Biblical scripture (Gen 1:5)

3. The Growing Period and the Human Portion of Responsibility

❖ Growing period : 3 Stages

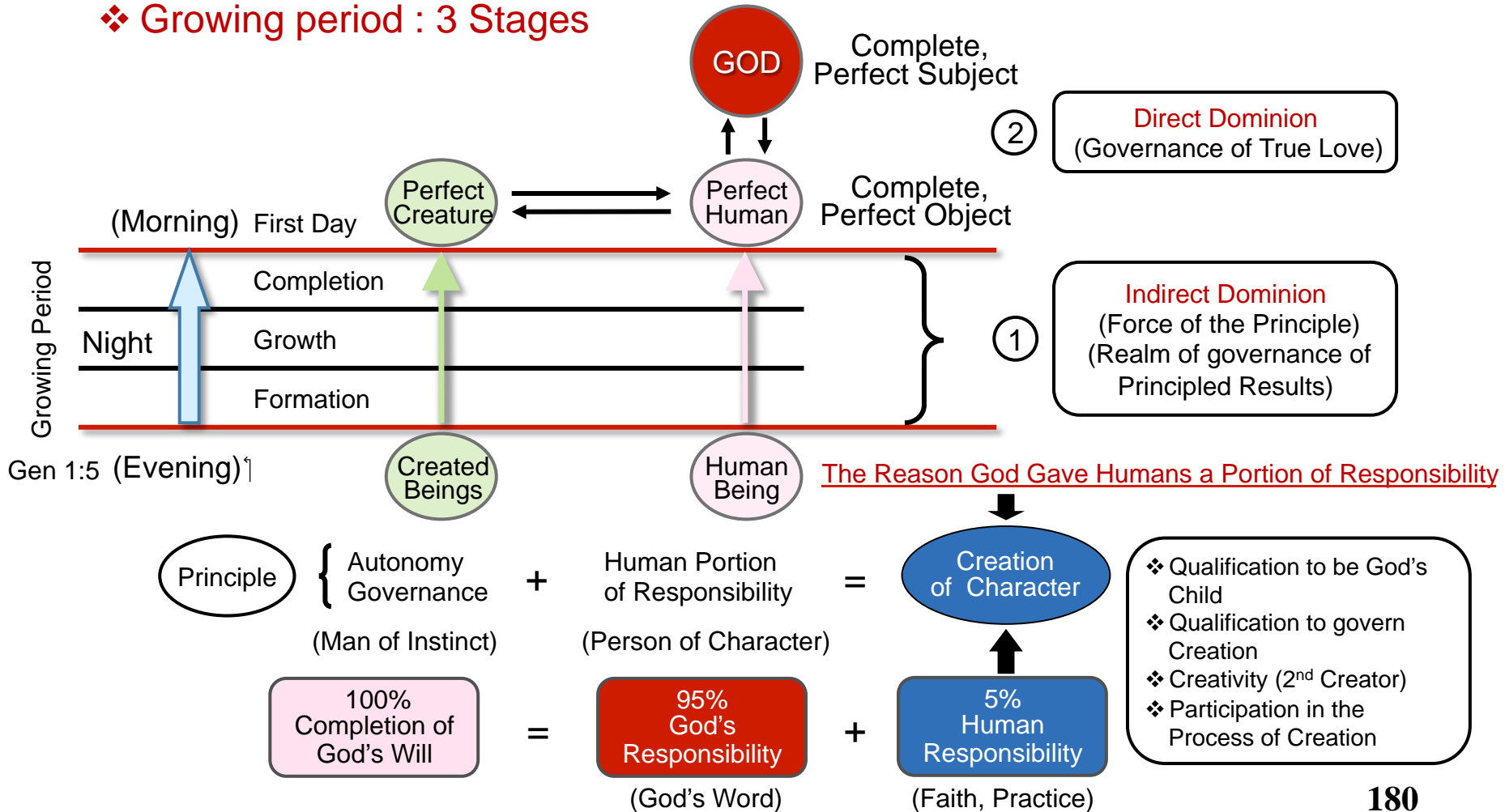

4. The Reason God Gave Humans a Portion of Responsibility

- 1) Because God created human beings, He has the qualification to govern them.
- 2) For human beings to gain the qualification to stand as God's children and govern all created beings, they must create those created beings. However, human beings do not have the capacity to create those beings.
- 3) For this reason, in the place of creating all beings, God has human beings create their own character through their own portion of responsibility. By giving human beings this portion of responsibility as something they alone can do, God intends that humans will earn the qualification to stand as God's children and govern all beings in the created world.
- 4) How then is the creation of human beings accomplished?
God gives human beings his Word as his own portion of 95% responsibility. When human beings believe in that Word and put it into practice by maintaining absolute sex and achieving self-governance, they fulfill their own portion of 5% responsibility and create and perfectly complete their own character.

5) Accordingly, human beings create their own character through their own portion of responsibility. In this way, they obtain a creative nature and become secondary Lords of Creation. They participate in God's masterpiece of creation and bring it to perfection and completion.

This is the reason why God gave a portion of responsibility to human beings.

❖ The realm of liberation of the portion of responsibility is perfectly completed through 'Absolute Sex'.

5. If and When the Portion of Responsibility is Fulfilled

- 1) If and when the human portion of 5% responsibility is perfectly completed, God's portion of 95% responsibility is also perfectly completed, and God's Will, that is the purpose of God's creation, is also perfectly completed.
- 2) If and when the human portion of 5% responsibility is perfectly completed, God's portion of 95% responsibility is also perfectly completed and God Himself becomes perfectly completed.
- 3) When the human portion of 5% responsibility is perfectly completed and Adam becomes the substantial True Parent, God, who is the invisible formless True Father, manifests and incarnates as the substantial True Parents.

VI. The Incorporeal Substantial World and the Corporeal Substantial World Centering on Human Beings

1. Does the Spirit World Exist? What is My Relationship with it?

1) From the Perspective of the Principle of Creation (Dual structure of the Cosmos)

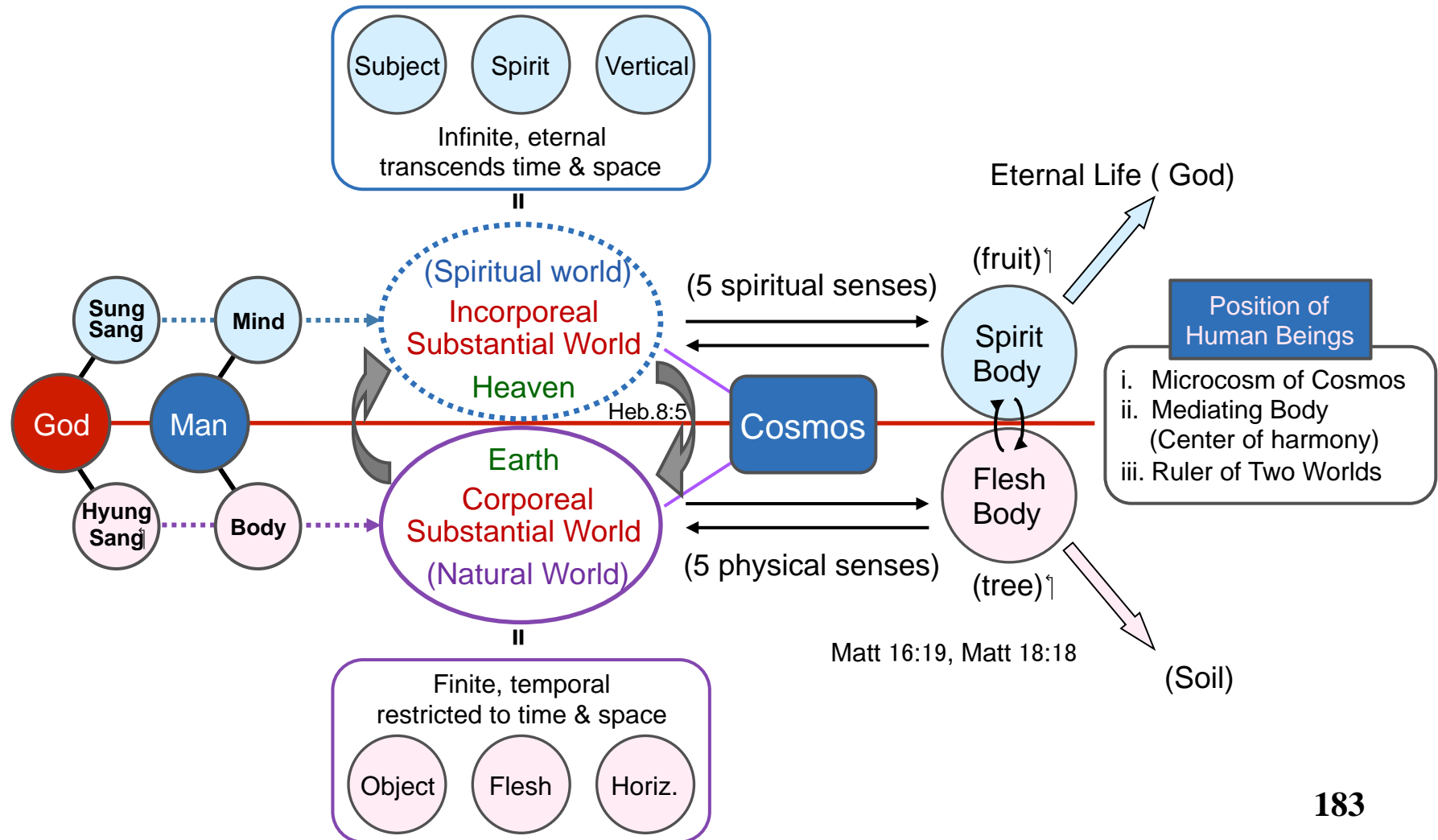

2) From the Perspective of Biblical Scripture

Gen 1:1 God's creation of heaven & earth (creation of the spirit world and the natural world)

3) From the Perspective of Creation of the Spirit Self

(1) Bible Verses about the Spirit Self

(Genesis 2:7)
nostrils → **breath of life**
dust (earth) → **Flesh body**

(I Corinthians 15:44)
spiritual body = **lives again**
flesh body = **troubles**

(Ecclesiastes 12:7)
spirit (soul) **returns to God** → **Eternal Life**
dust (body) returns **to the earth**

(2) Reappearance of spirits

Matt 17:1-10 : Moses and Elijah with Jesus
Luke 9:28-30 : Peter and John and James, and went up on the mountain to pray.
And behold, two men talked with him, Moses and Elijah,
Acts 9:3-5 : Saul, Saul, why do you persecute me?
II Cor 12:1-4 : (Saul writes) whether in the body or out of the body I do not know
Rev 22:20 : Amen. Come, Lord Jesus!
Luke 16:19-26 : Poor man named Lazarus and the rich man

2. The Three Life Stages of Human Beings

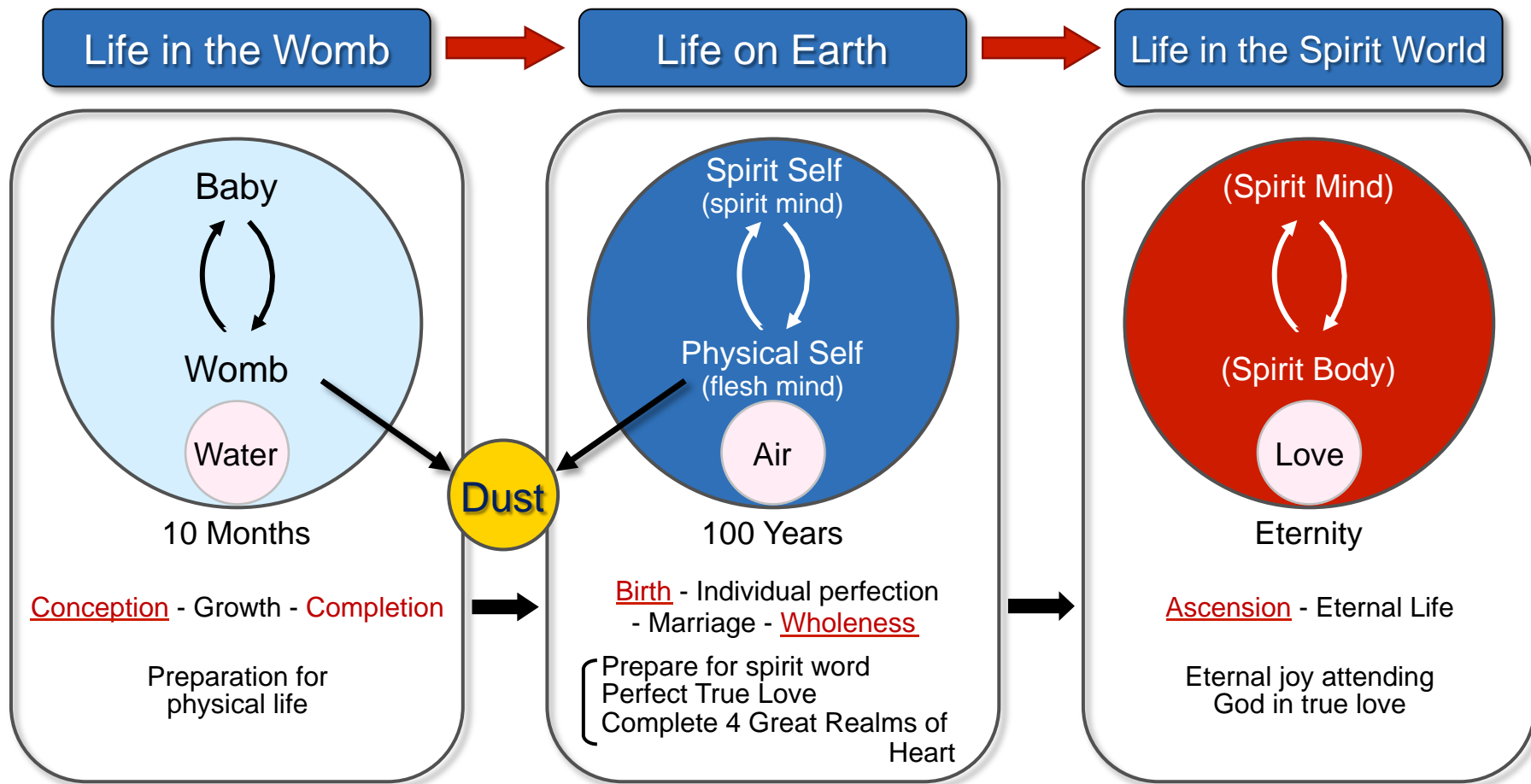

Surprise on arrival in spirit world (Why? Two bodies, have a spiritual body, no pain)

Helicopter Accident (July 19, 2008)

July 19 = Victory of Rebirth, August 8 = Victory of Resurrection, August 28 = Victory of Eternal Life → Sung Hwa (Ascension)

Luncheon celebrating Victory of Substantial Complete Recovery

3. Structure and Relationship of the Physical Self & Spirit Self

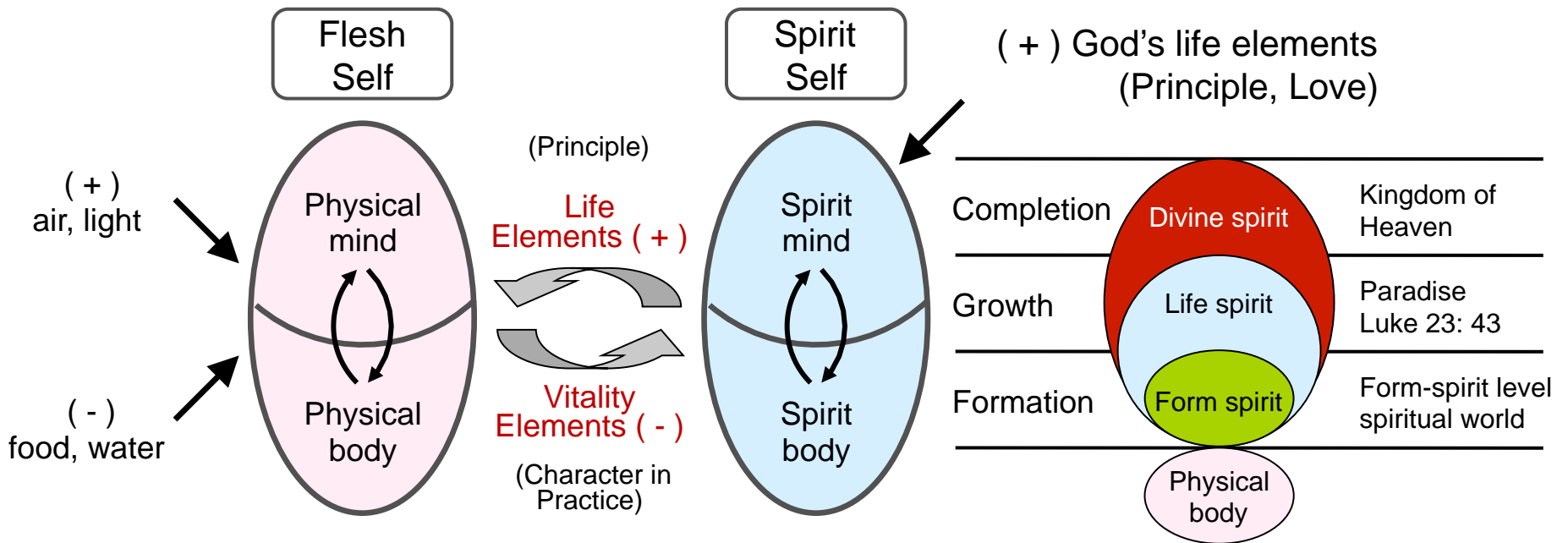

Perfection of Human Beings → Perfection of the Spirit Self →
 Perfection of the Spirit Mind → Perfection of Shim Jung (Perfection of True Love)



Perfection of Absolute Sex (Perfection of the True Blood Lineage)

1) The Importance of Physical Life

- i. The spirit self grows and matures to completion through the physical self (completes the 3 stages of growth).
- ii. Life on earth: Perfection of the 4 Great Realms of Heart
→ Experience true love (perfectly complete true love)
- iii. Release from sins must be accomplished on earth
(Liquidation by establishing conditions of indemnity)
- iv. Physical self → Birth of the spirit self (reproduction)
- v. Life on earth determines one's life in the spirit world

Practice of Physical Life { Life of Goodness → Spirit self becomes good → Heaven
Life of Evil → Spirit self becomes evil → Hell

The spirit self is the greatest masterpiece of our human lives

Conclusion Why do human beings need to live of goodness (principled life)?

→ Because the Spirit World exists

2) The Importance of the Spirit Self

- i. Owner of the spirit world (owner of love)
- ii. Subject of the physical self
- iii. Communicates with God spiritually (living in attendance)
- iv. Eternal life
- v. Same shape and appearance as the physical self
- vi. One's life is automatically recorded within the spirit self (video tape)

3) Determination of Heaven and Hell

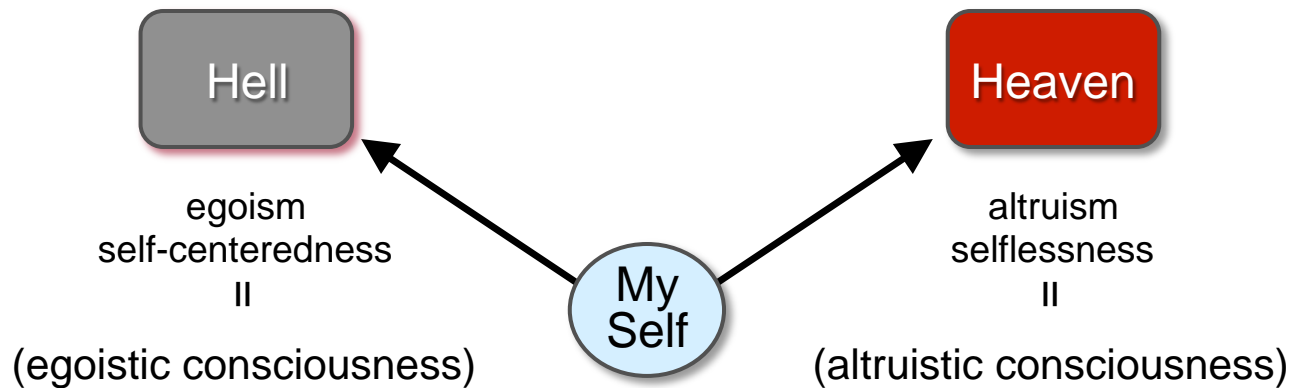

4) Is Heaven somewhere God sends you? Or somewhere you find?

A place you find

→ You first complete your spirit self to become a person of Heaven, then to live in Heaven

(1) Did you live for others?

Those who lived for themselves → Hell

Those who lived for others → Heaven

(2) Did you love your enemies?

How many people actually like or love me?

If your descendants live improperly on earth, then you too will go to hell, and your ancestors who live in the spirit world will also experience suffering.

5) The Three Stages of Judgment in Spirit World

- (1) The Judgment of Character = Love
- (2) The Judgment of Meritorious Service = Public Life (human beings are public beings)
- (3) The Judgment of Public Funds = All things are public things.

6) Three Ironclad Rules All Human Beings Must Observe

- (1) Preservation of Lineage (Purity/Chastity)
- (2) Prohibition from Violation of Human Rights
- (3) Prohibition from Plundering Public Funds

7) The Blessings of God

Inheritance of God's True Love, True Life and True Lineage
Raise up the sprouts of True Love that God has
engrafted into you.

→ "True Love, True Life, True Lineage"

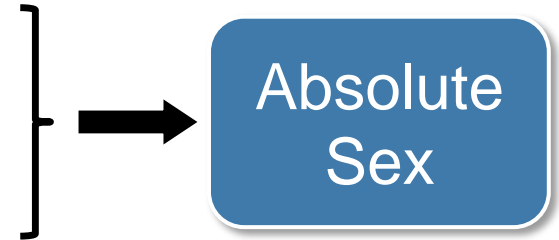

Pure Living – Pure Lineage – Pure Love – Pure
Marriage (Piety, Loyalty, Fidelity) – Pure Family
– Pure Nation – Pure World – Pure Heaven

→ (CHEON II GUK)

4. The Human Mind from the Perspective of the Relationship b/n the Spirit Mind and the Physical Mind

1) The Relationship between the Spirit Mind and the Physical Mind is like the Relationship between Sungsang (subject) and Hyungsang (object).

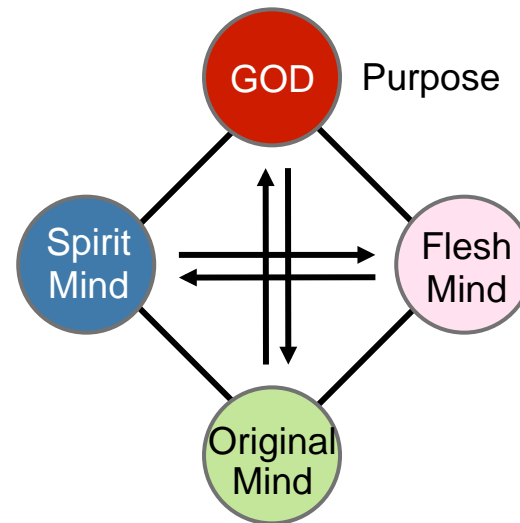
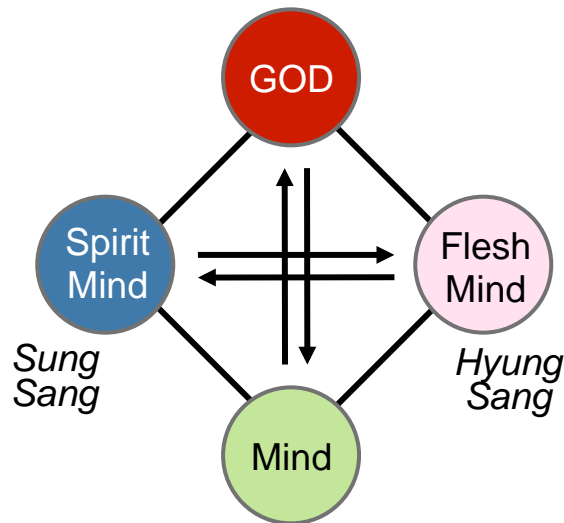

(Unified as one body)

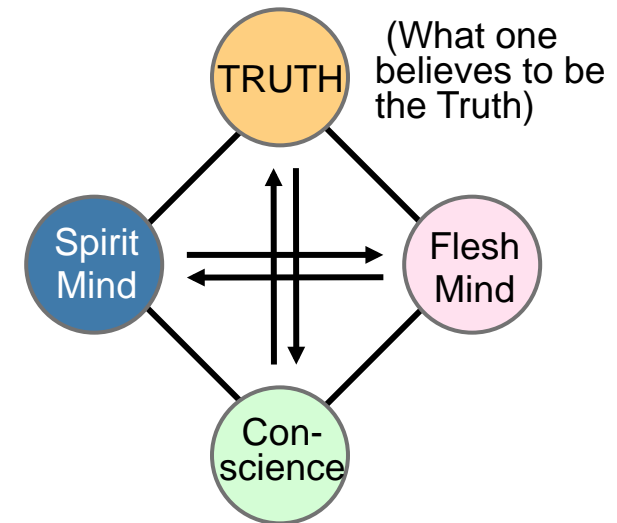

(Unified as one body)

[When united as one,
forms an active body

[Flesh mind: disappears along with the physical body
Original mind: remains within the spirit self

Fallen human beings → directional nature of the original mind leads them to do good. However, fallen humans have lost the standard of absolute truth → Each individual's standard of conscience differs centering on what that individual believes to be true. This is the reason why the direction of the conscience differs when a person's ideology or philosophy is different.

2) The Relationship Between the Original Mind and Conscience

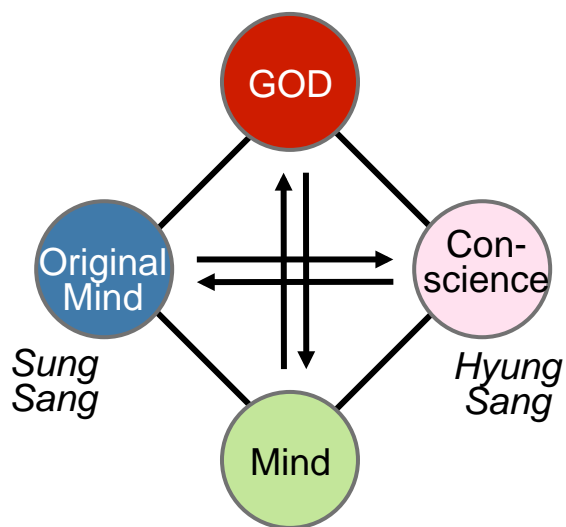

- i. Same as the relationship b/n Sungsang (internal nature) and Hyungsang (external form)
- ii. Same as inside and outside
- iii. The original mind and conscience always direct themselves to God's purpose of goodness and follow that Will.
- iv. The original mind and conscience resist the evil mind, which heads in the opposite direction to God's Will. Instead, they direct themselves towards goodness.

3) The Spirit Mind and the Flesh Mind of a Fallen Human Being

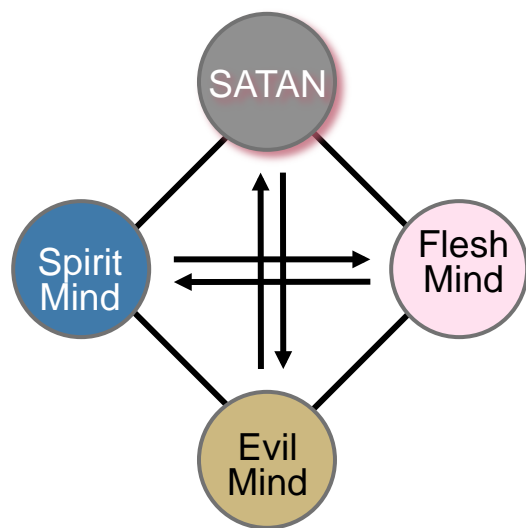

- i. Due to the fall, the spirit mind is unable to properly receive life elements from God and in its immature state resides under the influence of Satan.
- ii. In this state, the spirit mind is unable to stand in the subject position to the physical mind and is instead governed by the physical mind.
- iii. This immature spirit mind engages in give and receive action with the physical mind that is under Satan's dominion to form the unified single body that we call the evil mind.

5. Points to Remember

1) The Principle (True Father's Teaching) is Food for My Spirit Self.

- i. Food for the flesh – food and drink
- ii. Food for the spirit – Principle (God's Word) = 'True Love'
- iii. If you listen to the Principle and then forget it, the only thing remaining will be Satan's thoughts and Satan's words.

2) Prayers of Repentance are Air for My Spirit Self

- i. If you do not pray everyday, you will have no air. This is a dead person.
- ii. Prayer is conversation with God. If you do not converse with God, you will be conversing with Satan.

3) Complaint and Dissatisfaction are Poison for My Spirit Self (deadly poison)

- 4) Judgment
- i. Judgment of the Word: Did you believe in God's Word?
 - ii. Judgment of Character: Did you practice God's Word?
 - iii. Judgment of the Heart: Did you love?

Did you love God? Did you love humanity? Did you love the creation?

Let's live for the sake of others!

- End -

The Human Fall

Section 1. The Root of Sin (Original Sin)

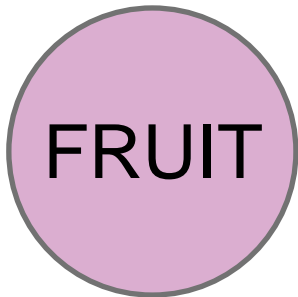

i. Literal ?

- [God's Word: Gen 2:17 **Death** more valuable than life
- [Jesus' Word: Mark 7:15, Matt 15:11 (Mouth – not sin)

ii. Symbol

What does the Fruit of G&E symbolize?

What was the fruit of the tree of the knowledge of good and evil, such that Adam and Eve could not be forgiven and that God cast them out of the garden?

(Jesus: forgiveness, love your enemy)

(1) The Tree of Life & the Tree of the Knowledge of Good and Evil

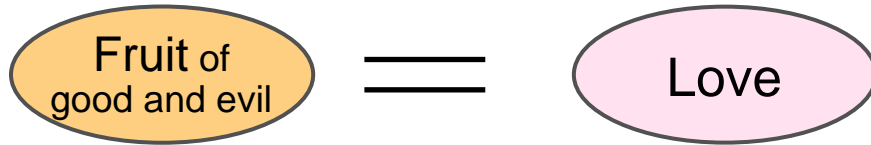

Gen 2:9 { Tree of Knowledge of Good & Evil = Perfected woman (Eve)
 Tree of Life = Perfected man (Adam)

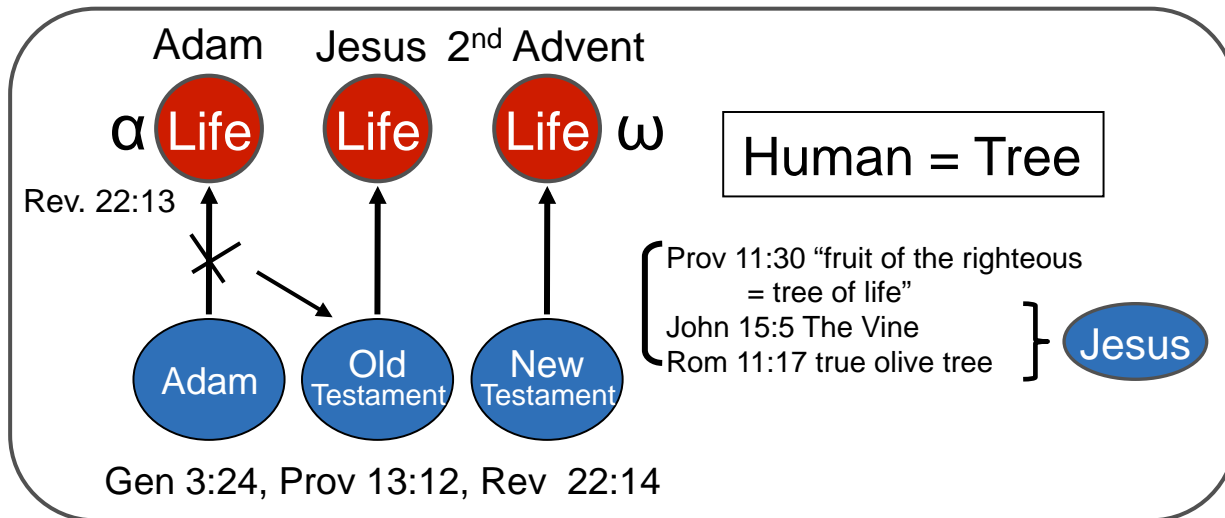
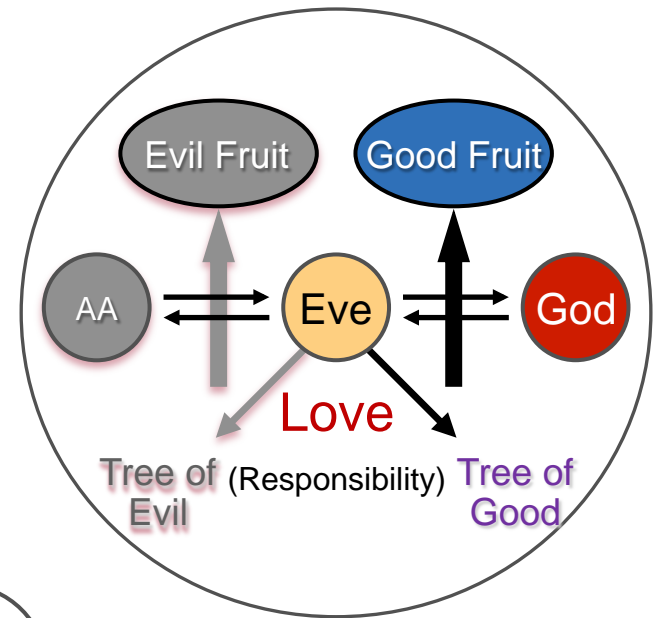

- Tree of Life = Adam who perfected the ideal of creation
- Tree of the Knowledge of Good & Evil = Eve who perfected the ideal of creation
- Fruit of the Knowledge of Good & Evil = The Love of Eve

(2) The Identity of the Serpent

- i. Conversed with humans
- ii. Knew the will of God
- iii. Tempted human beings, intellectual
- iv. Lived in heaven (Rev 12:9)
- v. Ability, power
- vi. Transcends time and space

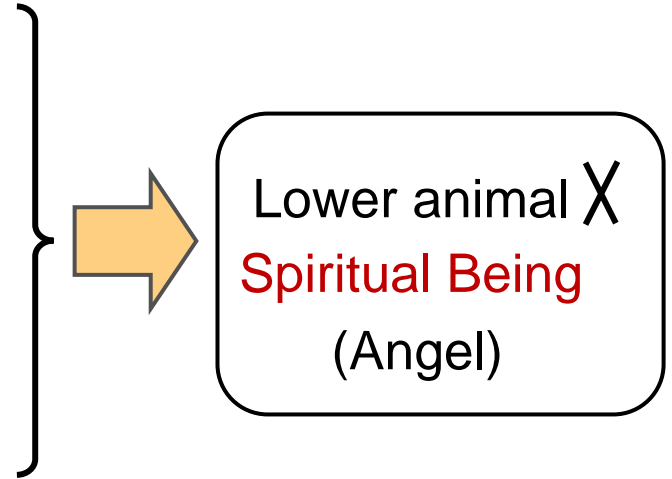

(3) The Fall of the Angel and the Fall of Human Beings

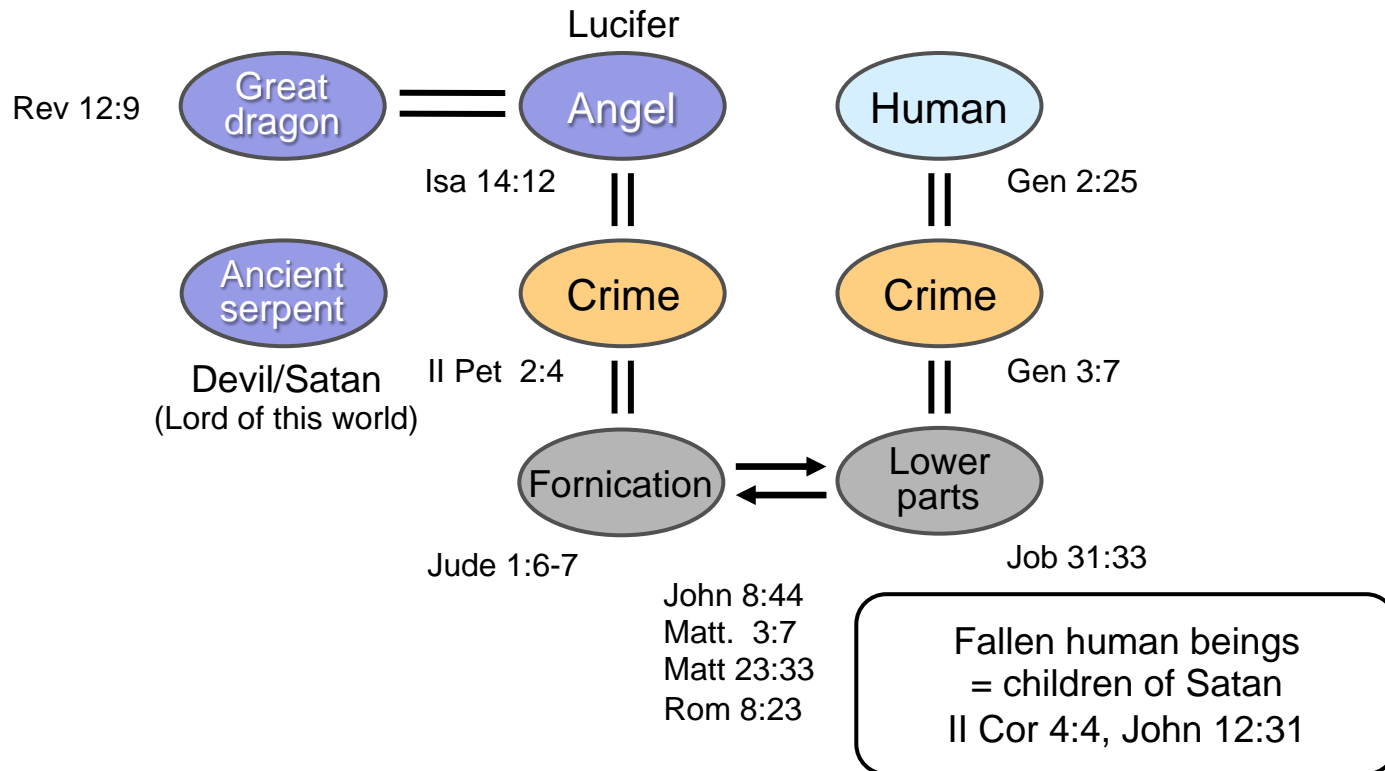

- **Snake (Satan):** Fallen Archangel Lucifer (god of this world, acting like a king)[†]
- **Root of Sin:** Immoral sexual relationship (blood connection) b/n the fallen Archangel and Eve (lust)
- **Fallen Humans:** children of Satan (inheriting the false love, life and lineage of the servant)

2. The Motivation and Process of the Fall (Why did the Fall Occur ?)

1) Purpose for which the Angels were Created

(1) The Mission of Servant (Heb 1:14, Rev 22:9)

- i. Gen 18:10 – Conveyed God’s message of blessing to Abraham
- ii. Matt 1:20, Luke 1:31 - Conveyed the message of the conception of Christ
- iii. Acts 12:7-10 - Helped Peter to escape the prison by taking the chains of his hands

(2) Praise and worship

- i. Rev 5:11 “And I beheld, and I heard the voice of many angels round about the throne and the living beings and the elders; and the number of them was ten thousand times ten thousand, and thousands of thousands.”
- ii. Rev 7:11 “And all the angels stood round about the throne, and about the elders and the four living beings, and fell on their faces before the throne and worshiped God.”

2) The Motivation and Process of the Fall

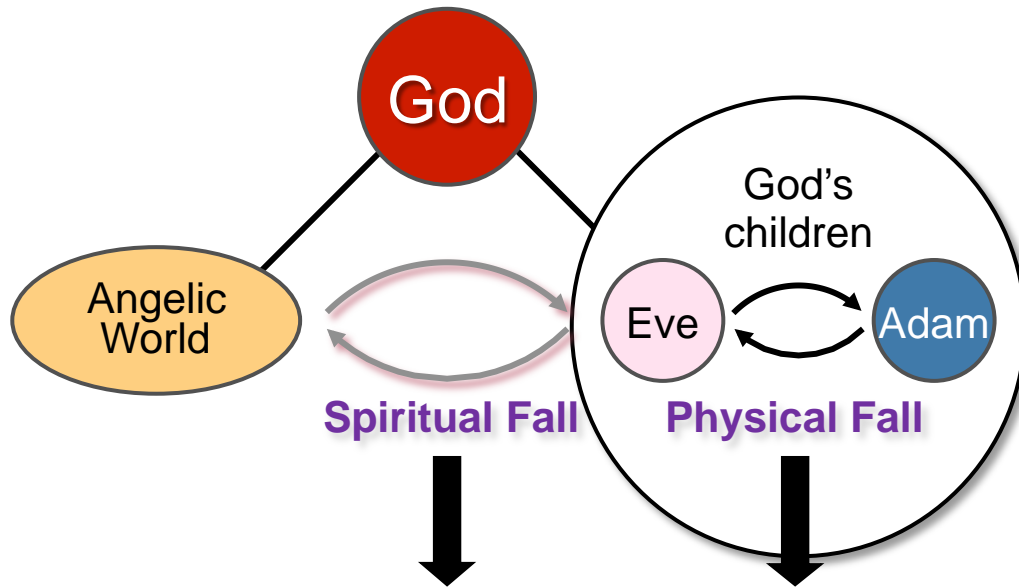

Feeling a Reduction of Love	Motivation	With the heart to return once again to God
Spiritual Fall	Process	Physical Fall
Guilty Conscience Fear, Dread, Anxiety Angel's Wisdom	Effects	Inherited the nature of the Archangel at the time of the Fall (Fallen Nature) Became children of Satan Satan becomes the master of the world

3. How was it Possible for Human Beings to Fall during the Growing Period?

1) The Power of Love and the Power of the Principle

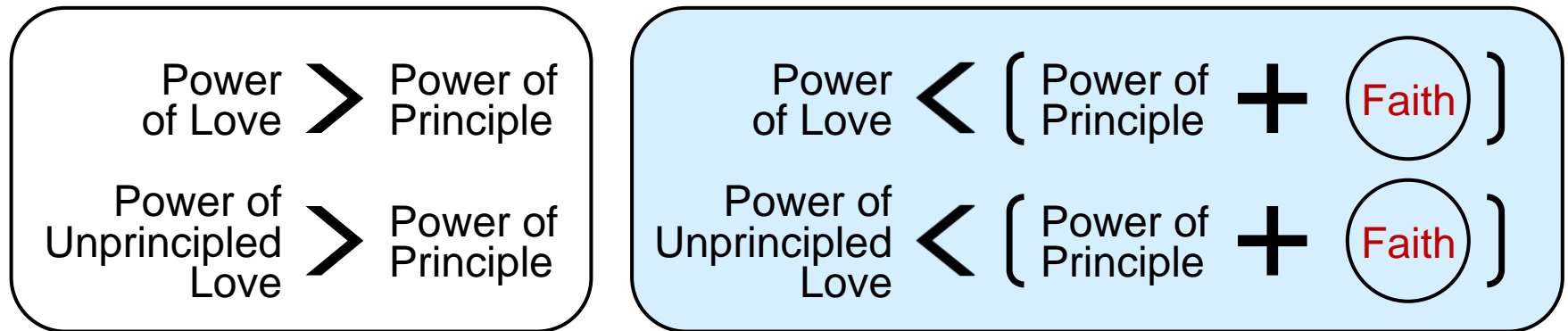

- i. During the growing period, it was possible for an immature Adam and Eve to Fall at any time if they encountered the power of unprincipled love (the angel's love).
- ii. This is similar to a situation where a train functions properly and the rail also functions properly but where the train can still be derailed if it collides with an external force coming from a non-aligned direction.

2) Why God Set Up the Commandment

God gave the Commandment in order to prevent the Fall. During the period that Adam and Eve were immature, God could not govern them directly through love alone. Therefore, if they encountered a non-Principled form of love during this period, it was possible for them to fall. For this reason, God gave them the Commandment in order to prevent them falling.

3) The Period during which the Commandment was Necessary

The Commandment was necessary during the Growing Period

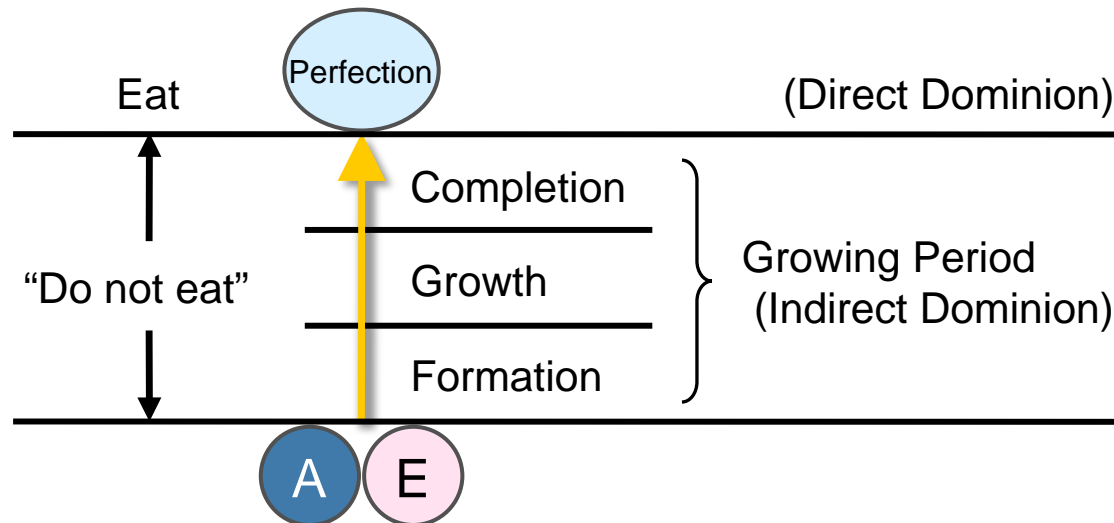

4. The Consequences of the Human Fall

1) Satan and Fallen Human Beings

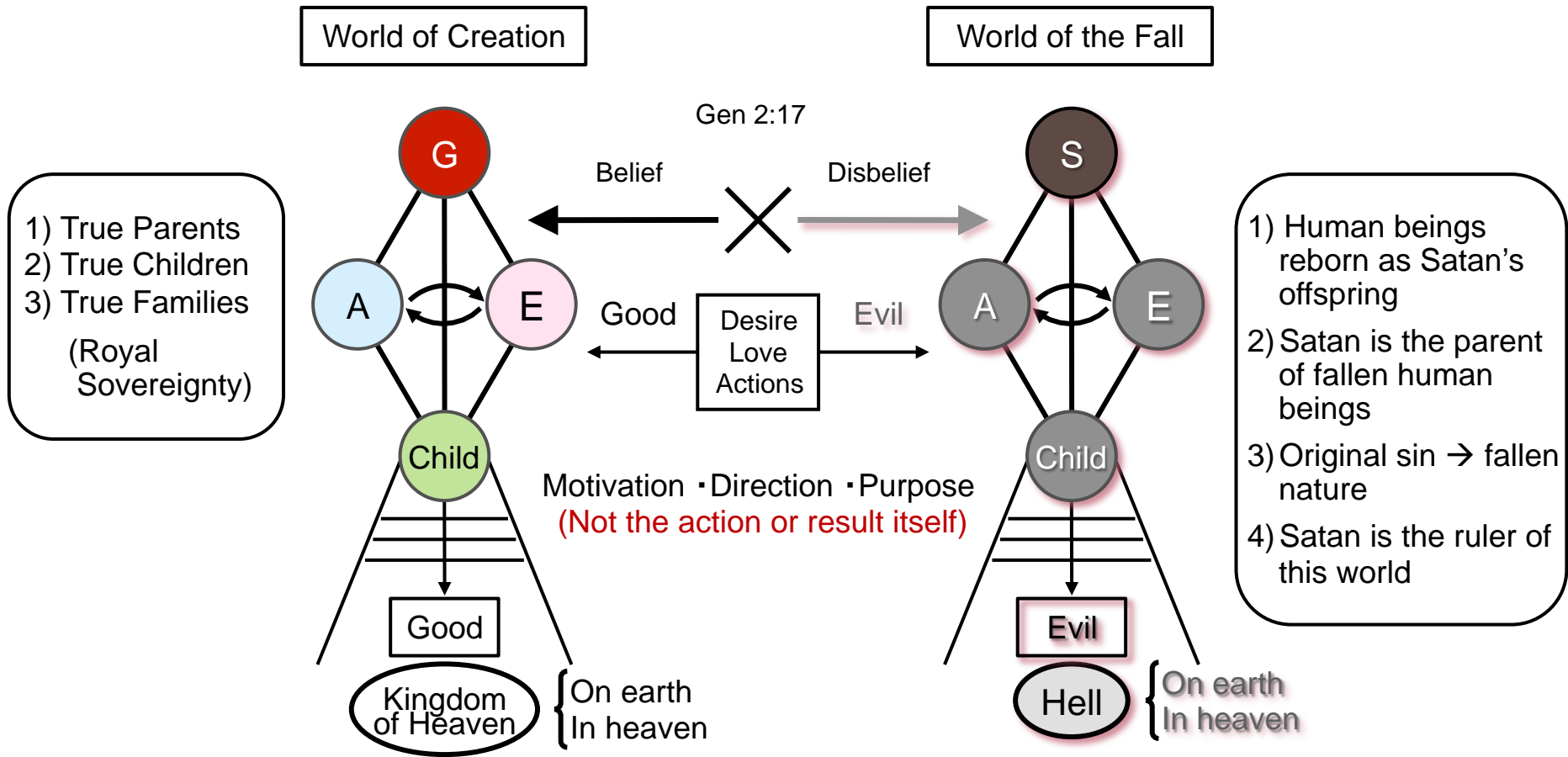

(1) The Three Great Changeovers

- i. Change of Lineage
- ii. Changeover of the Right to Ownership
- iii. Changeover of the Realm of Heart (original nature)
– practicing a life of attendance

(2) The Three Great Liberations

- i. Liberation from Satanic lineage (**eradication**) → **The Blessing**
- ii. Liberation from Satanic governance (**fallen nature**) → **Principled Life**
- iii. Liberation from Satanic lifestyle (**environment**) → ***Cheon Il Guk***

Realization of True Families (Ideal World)



Creation of God's Homeland



Cheonju Pyunghwa Tongil Geuk
(Nation of Cosmic Peace and Unity)
'Cheon Il Guk'

2) Satan's Activities in the Human World

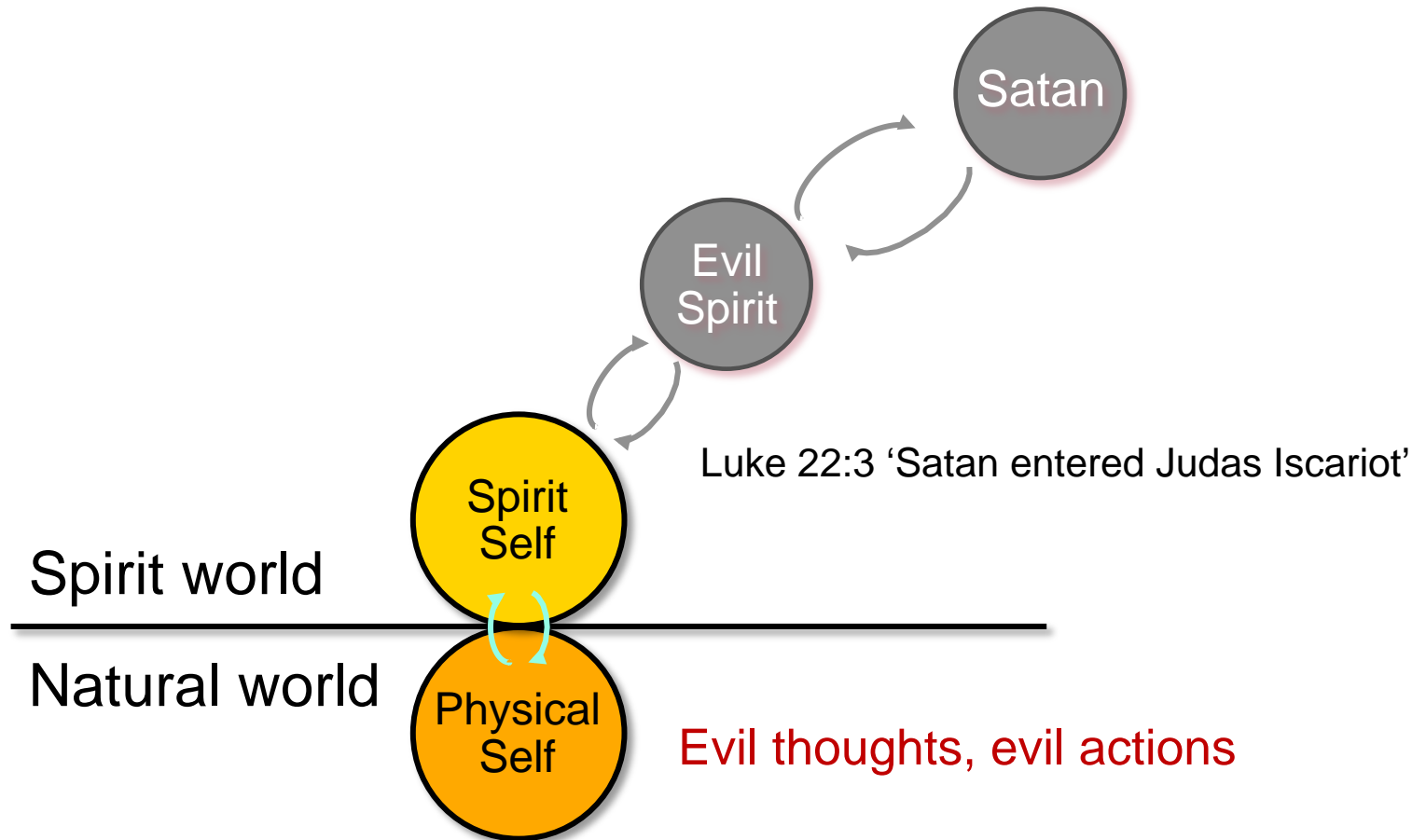

3) What is Sin?

1) Definition: Sin is a violation of heavenly law which is committed when a person forms a common base with Satan and sets a condition allowing give and receive action with him.

2) Types of Sin

- i. Individual sin (leaves)†
- ii. Collective sin (branches)†
- iii. Hereditary sin (trunk)†
- iv. Original sin (roots)†



4) Fallen Nature

When the Archangel betrayed God and formed blood ties with Eve through a sexual relationship, certain tendencies, inclinations, dispositions and temperaments incidentally arose in the Angel as a result. All these tendencies, inclinations, dispositions and temperaments were then inherited by Eve and Adam and became the fundamental nature giving rise to fallen nature.

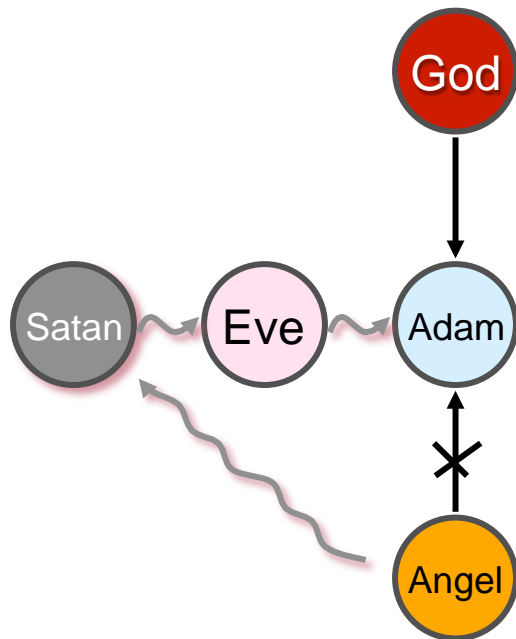

Original Nature	Fallen Nature	Restoration
i. God's Viewpoint (love)	Inability to love from God's viewpoint (jealousy, envy)	Love
ii. Position for existence (mediator)	Leaving one's 'position for existence' (rashness and intemperance)	Mediator
iii. Governance (obedience & submission)	Reversal of governance (arrogance)	Obedience & submission
iv. Multiplication of goodness	Multiplication of evil (stubbornness)	Sacrifice & offering

5. Freedom and the Human Fall

1) The Principle Perspective on the Meaning of Freedom

(1) There is no freedom apart from the Principle.

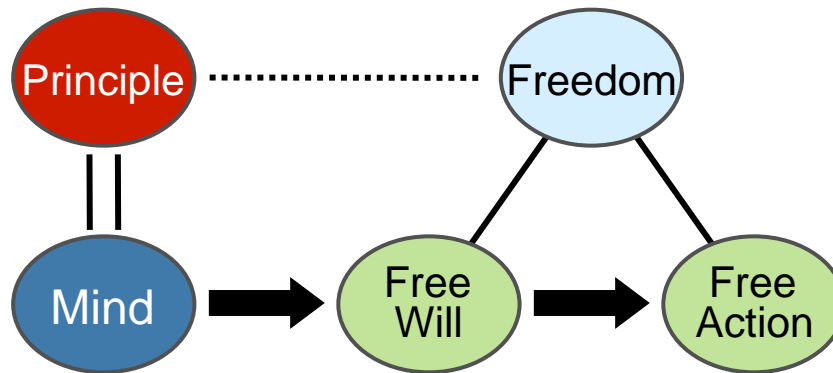

(2) There is no freedom without responsibility.

Human beings perfect themselves by completing their portion of responsibility by the power of free will. Accordingly, there is no freedom without responsibility.

Freedom without responsibility is not freedom; it is self-indulgence and dissolution.

(3) There is no freedom without accomplishment.

Through free will, the fruits of action are perfected so that human beings can obtain accomplishments that return joy.

2) The Fall was not caused by Freedom.

Human beings lost true freedom because of the Fall.

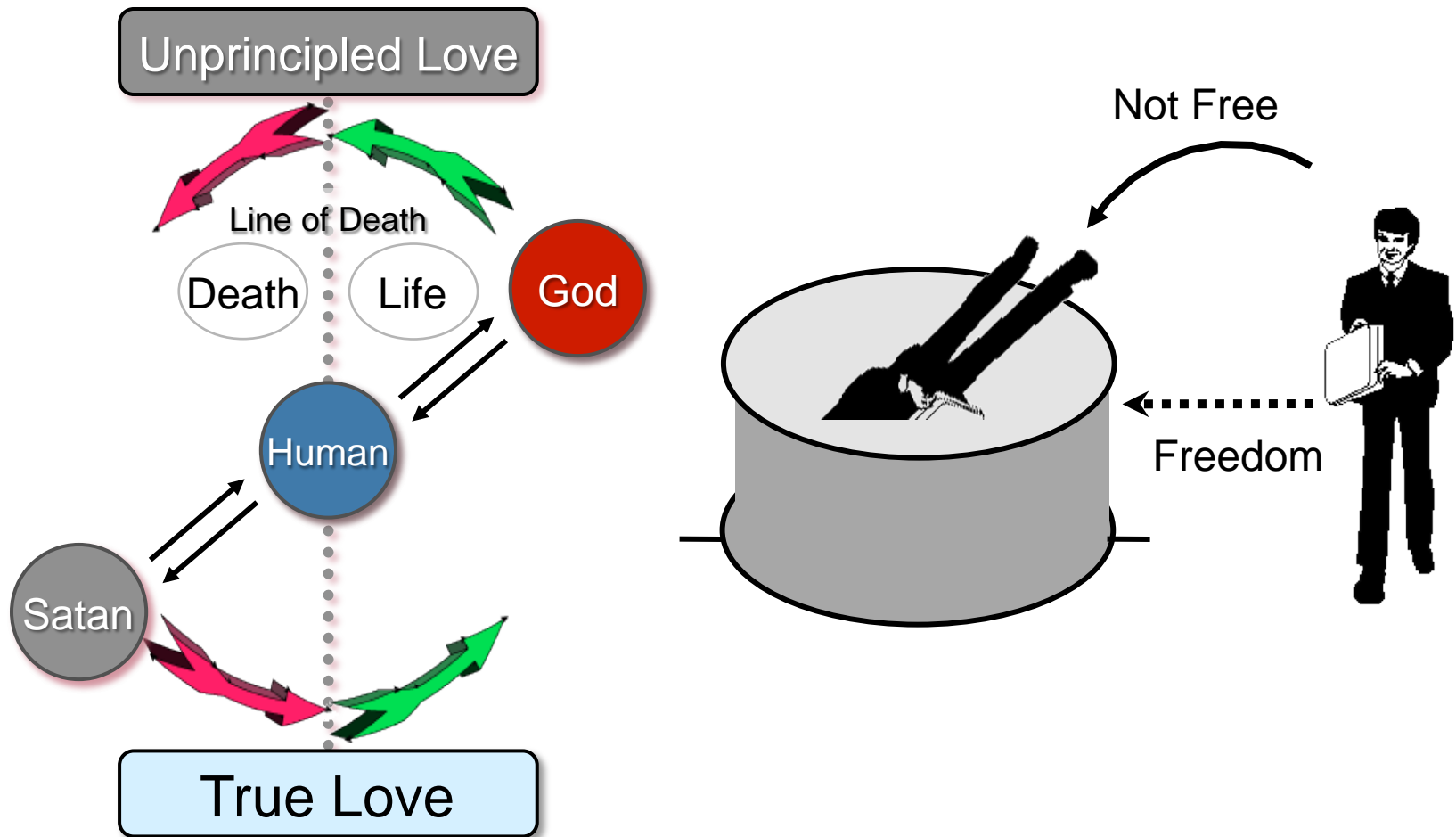

3) Reason That God Gave Humans Freedom

Freedom: Freedom moves human beings to take up the responsibility given to them through the Principle of Creation and seek substantial outcomes that bring God joy.

Free Action stemming from Free Will

→ Good Results → Bring Joy to God

4) Desire

Desire: Original Nature of Creation given by God to human beings

Purpose of Creation: Joy → Joy is experienced when Desire is fulfilled.

If human beings had no desire:

- Human beings could not experience joy
- They would not have a desire to receive the love of God
- They would not have a desire to live
- They would not have a desire to practice goodness
- They would not have a desire to develop themselves
- Neither God's Purpose of Creation or Providence of Restoration could be fulfilled
- Human society could not be sustained, nor would it develop

6. The Reason God Did Not Intervene in the Fall

1) To Maintain the Absoluteness and Perfection of the Principle

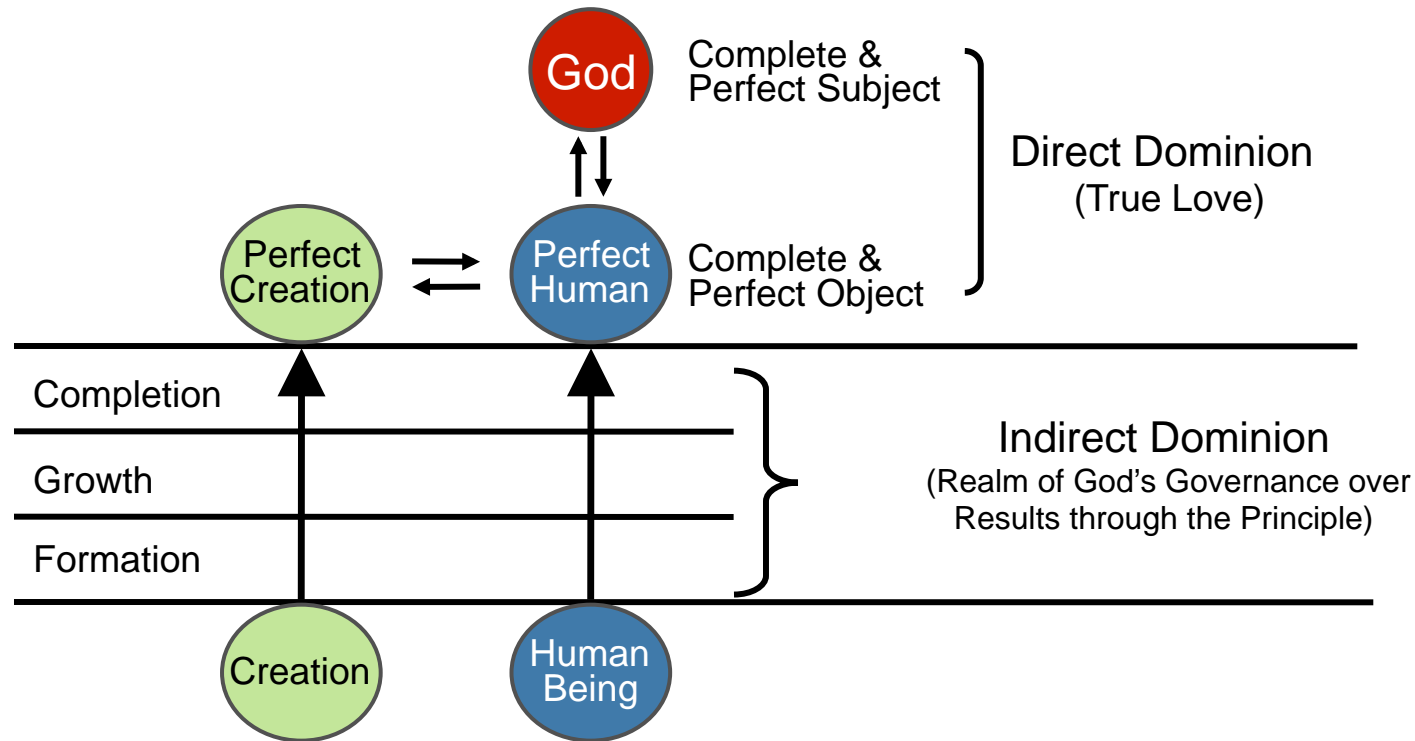

Principle [Autonomy Governance + Human Portion of Responsibility

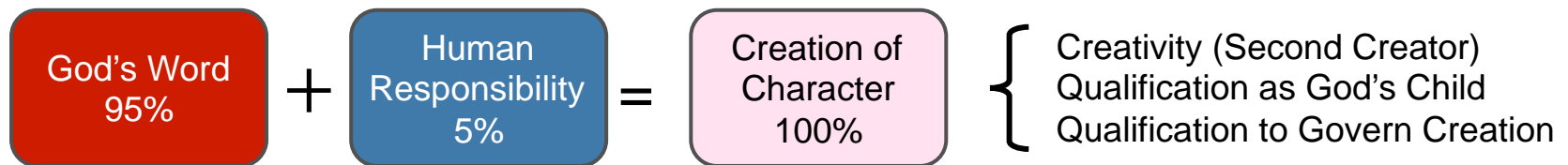

If God intervened, this would result in denial of the absoluteness and perfection of the Principle → God had no choice but to not intervene.

2) That God Alone Be Creator

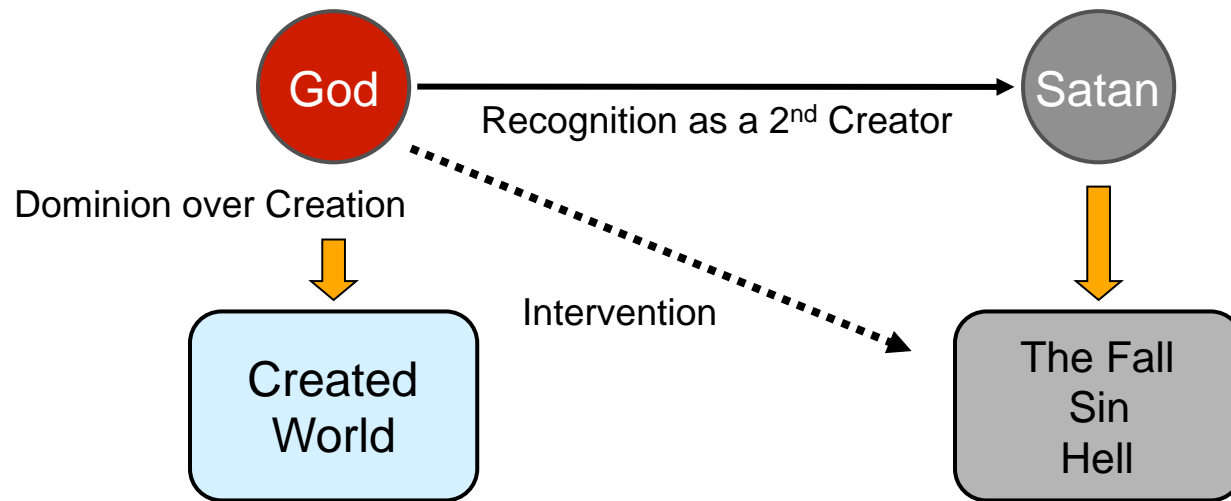

God only governs over that which has been created → If God intervened or acted to govern the Fall, it would assign creative nature to Satan.

The Fall, sin and hell are all things that Satan created.

Therefore, if God interfered with these, it would result in God recognizing Satan as a second Creator who created evil.

Accordingly, in order that God alone exists as the Creator, God had no choice but to not intervene in the Fall of human beings.

3) To Establish Human Beings in the Position to Govern over God's Creation

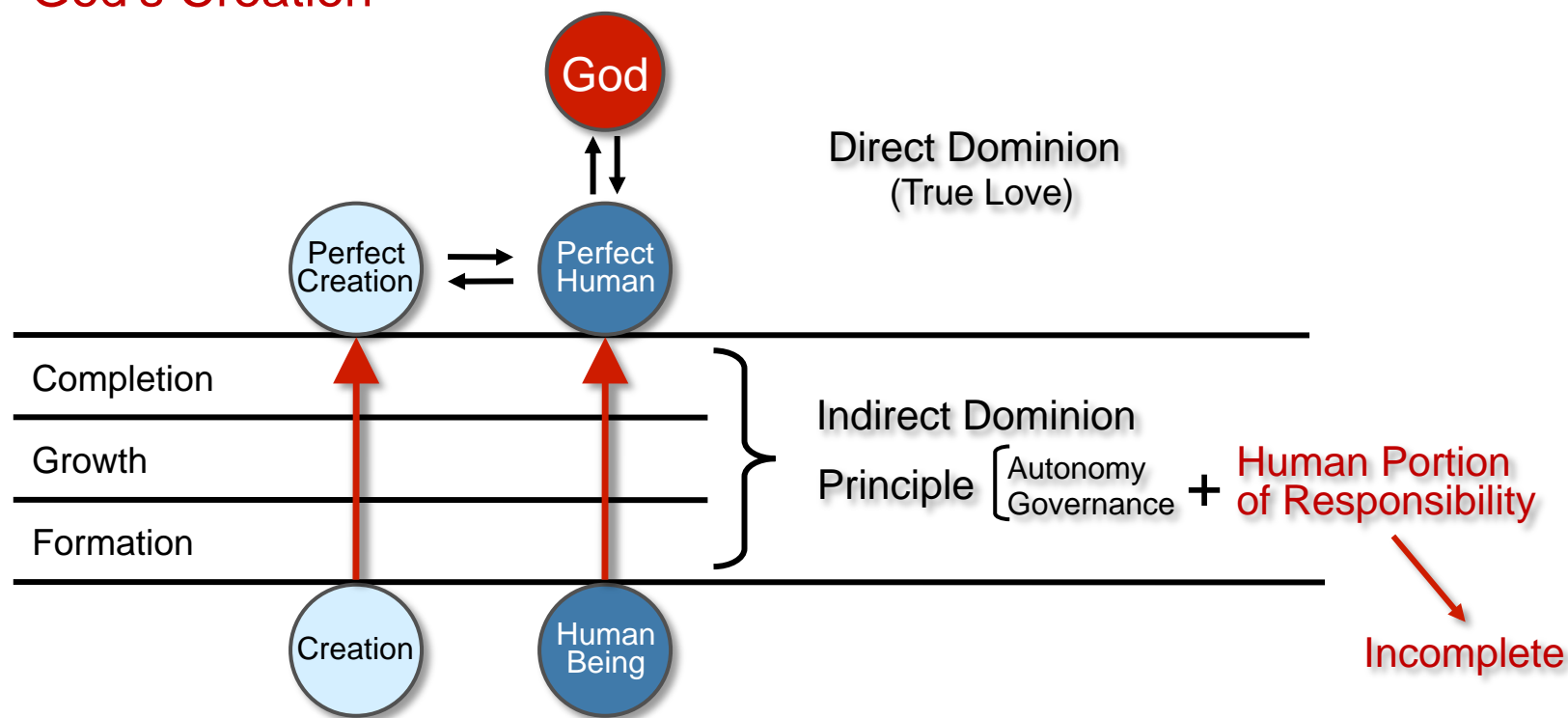

If God directly governed over human beings who are still within the realm of indirect dominion....

→ human beings would be unable to fulfill their own portion of responsibility

→ human beings would be unable to inherit the creative nature of the Creator

→ human beings would be unable to become God's children

→ human beings would be unable to attain the qualification to govern over the created world

For these reasons, God did not intervene in the Fall so that he could establish human beings as the Lords of creation.

7. The Anguish in God's Heart

1) Satan is an Adulterer (The Enemy of Love)†

(1) Satan is the Enemy of Enemies who violated the Four Great Realms of Heart.

Violation of the Four Great Realms of Heart
(daughter : sister, wife, mother, grandmother)†

(2) The *shimjung* of God, who must love the Enemy of Love

(3) The *shimjung* of God, who must love the children of the Enemy of Love more than he loves his own children

If God has the concept of 'enemy' within his *shimjung* (heart), he cannot become God, the Absolute Creator.

We have to know and understand the inexpressible heart of God and liberate Him from his anguish.

2) Why does God have to love his enemy?

(1) Because the motivation behind creation is *shimjung* (heart)

- i. This is the reason that Satan slanders God, telling him “you must love your enemy”.
- ii. During the growing period, human beings attain perfection with the assistance of the angels.
→ “How can these human beings be God’s children?”

(2) Because God is a parent of *shimjung* (heart)

Striking one’s enemy might bring momentary relief, but God cannot strike his enemy because he knows that the pain experienced in the heart of the enemy’s parents, in the heart of the enemy’s spouse, in the heart of the enemy’s children and in the heart of the enemy’s siblings and relatives would be even greater.

(3) Because striking one’s enemy means recognizing that enemy’s existence

The concept of ‘enemy’ does not exist within God’s ideal of creation.

For this reason, God cannot strike his enemy, Satan (who is the Devil) because if he were to strike Satan, it would be equivalent to recognizing Satan as his enemy.

This is why God began the providence to bring Satan to submit and surrender naturally.

3) The motivation behind the emergence of Satan

- (1) When one cannot love as God loves (feeling alienated or left out, a sense of decline or diminishment of self, feeling sorry for oneself)
 - (2) When one leaves one's proper position of existence (complaint, malcontent, dissatisfaction and discontent)
 - (3) When one strives to reverse governance (ignoring natural or principled order, doing as one pleases without regard to others)
- Live with absolute faith, absolute love, absolute obedience (submission)

4) Separation from Satan → Denial of Self

“Binding oneself using the Principle”
= Principled Life (God's way of life)
(Living for others)

- (1) Complaint, malcontent feelings, being discontent become conditions for Satan's accusation and slander, leading to an invasion by Satan.
E.g. Peter, Judas Iscariot (Luke 22:3)
- (2) Complaint and discontent are poison for my spirit self.

5) The Need for a Life of Faith

(1) Romans 7:22: Paul's lament → the realization that there are two laws at work
(the law of God, the law of Satan)

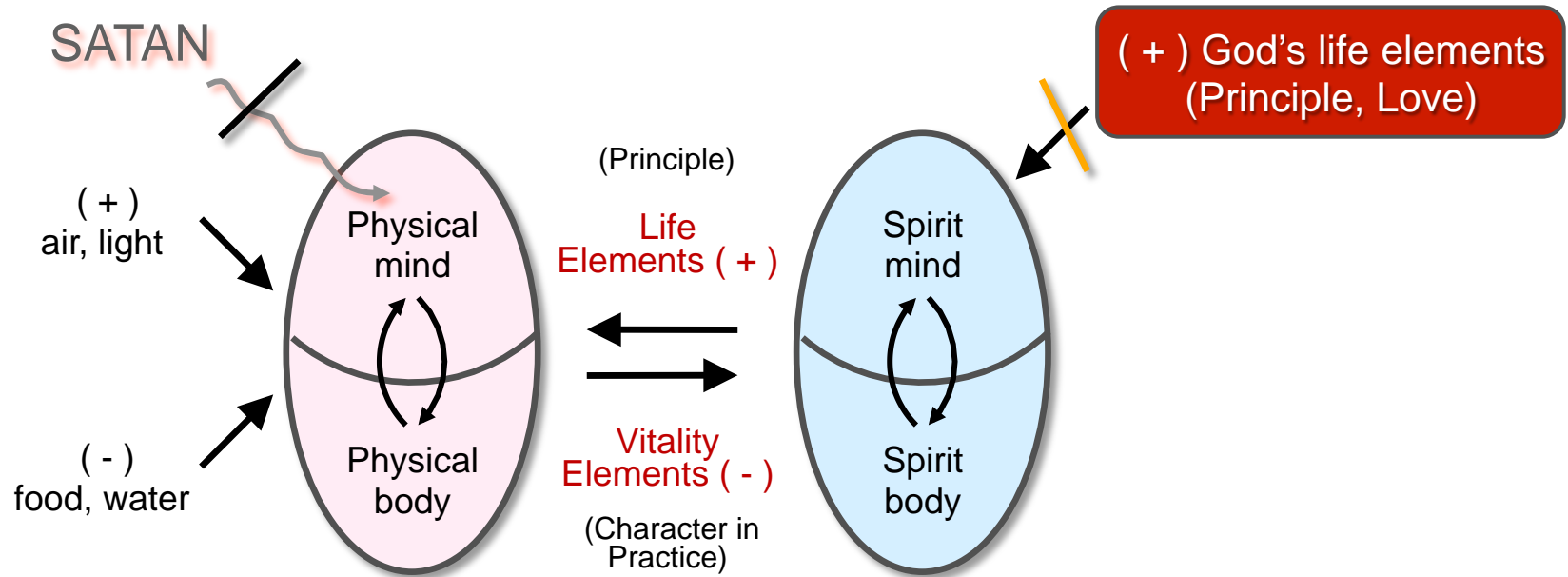

Thinking of Self (The Law of Sin)
Motivated by Self

(The Law of God) Living for Others
Motivated by God

1 John 1:8 -10

If we claim to be without sin, we deceive ourselves and the truth is not in us.... If we claim we have not sinned, we make him (God) out to be a liar and his word is not in us.

6) What we must do

- i. Become someone God can trust.
- ii. Understand and console the heart of God.
- iii. Become someone who can liberate God.

Eschatology & the End of Human History

1. The Meaning of the Last Days

(The Origin & Goal of Human History)

II Pet 3:12 heaven, earth X, fire judgment

Matt 24:29 sun, moon, stars

Thess 4:16-17 resurrection, ascend to heaven

- 1) Original history – history of goodness
- 2) Fallen history – history of sin
- 3) Salvation providence history – providence of restoration

(1) History of development of cultural spheres

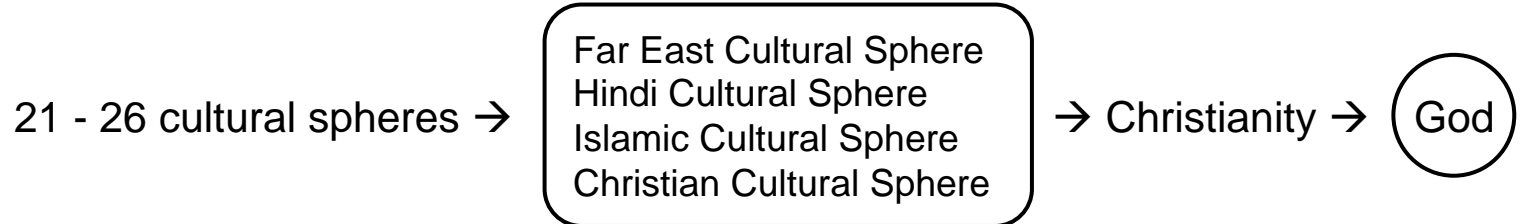

(2) Trends in religion and science

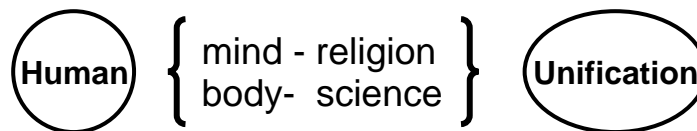

(3) Unfolding of the history of struggle

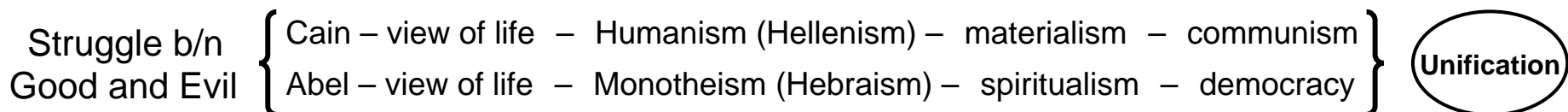

Introduction

We dwell in ignorance of history, uncertain about its origin, the direction in which it is heading, and its final destination. Concerning eschatology, or the doctrine of the Last Days, many Christians believe literally what is written in the Bible (II Peter 3:12 - heaven and earth judged by fire; Matt 24:29 - sun, moon, stars losing light, falling; I Thess 4:16-17 – resurrection, meeting with Christ in the heavens).

One pertinent question for Christians is whether these events will take place literally or whether the verses are symbolic, as are many parts of the Bible.

4) The Bible : Restoration of the Tree of Life (Gen 2:9 → Rev 22:14)

Gen 2:9

...the tree of life also in the midst of the garden, and the tree of the knowledge of good and evil.

Rev 22: 14

Blessed are those who wash their robes, that they may have the right to the tree of life and that they may enter the city by the gates.



Tree of Life

Perfected Adam
(True Father)

Garden of Eden

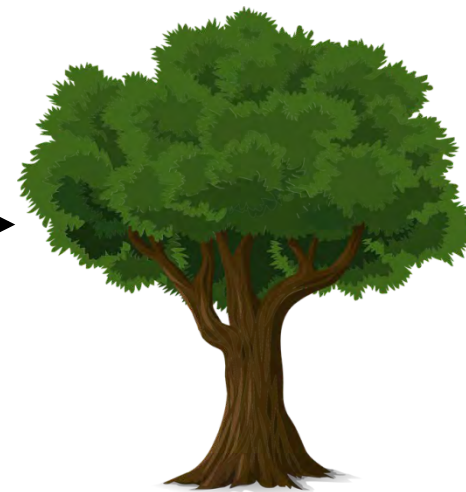

Tree of Life

2nd Coming
of Christ
(True Father)

Original World of
God's Creation

2. The Last Days

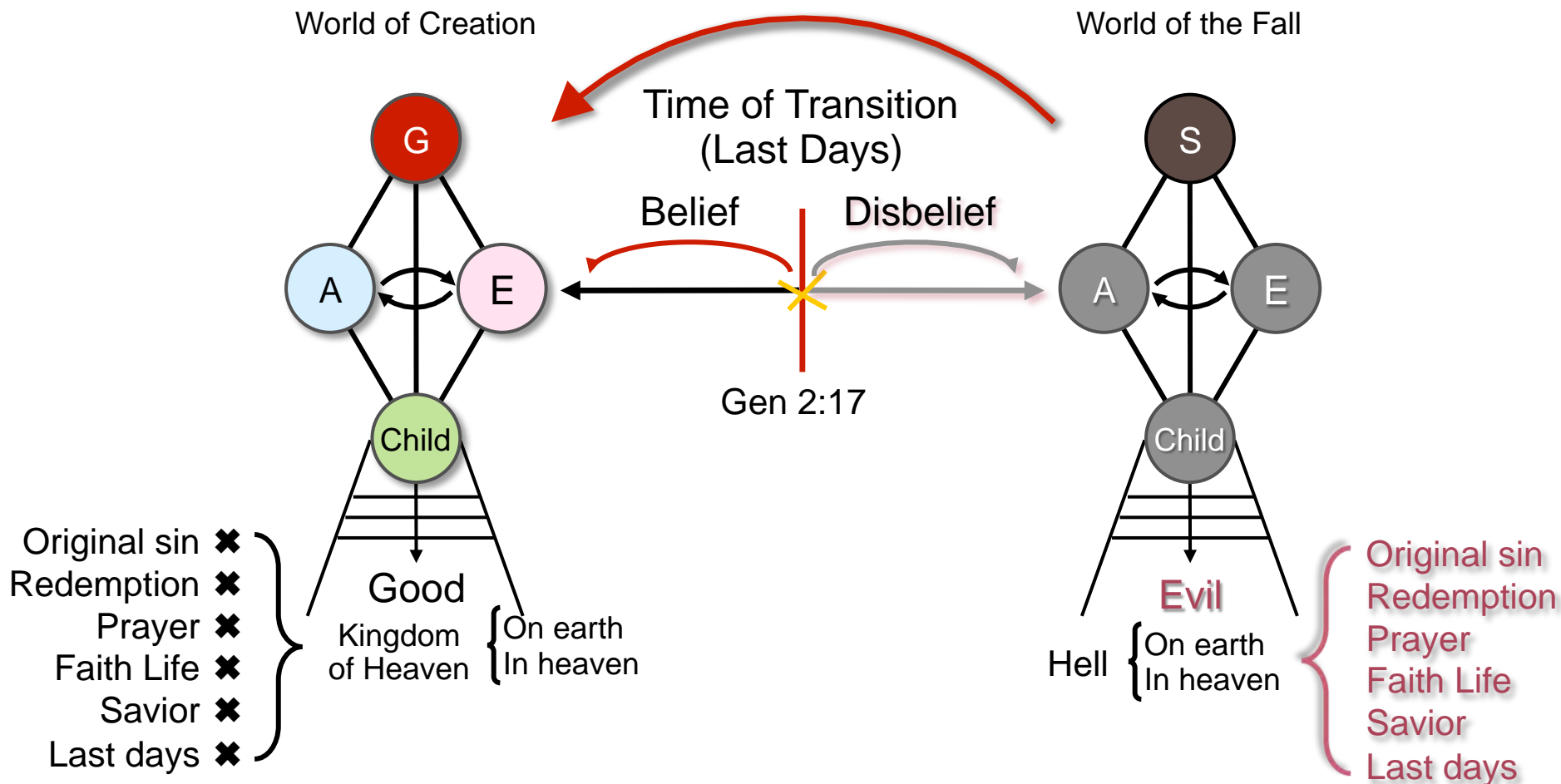

1) Meaning of the Last Days

The intersection point where the world of sin that centers of Satan (Satan's evil sovereignty) comes to an end, and the world of goodness that centers on God (God's good sovereignty) begins.

2) The Last Days Have Occurred Several Times

- i. Noah: Gen 6:13 “I have determined to make an end of all flesh; for the earth is filled with violence through them; behold, I will destroy them with the earth.”
- ii. Jesus: John 5:22, Mal 4:1
- iii. Second Coming: Matt 24:29, Luke 17:26¹ “As it was in the days of Noah, so will it be in the days of the Son of man....”

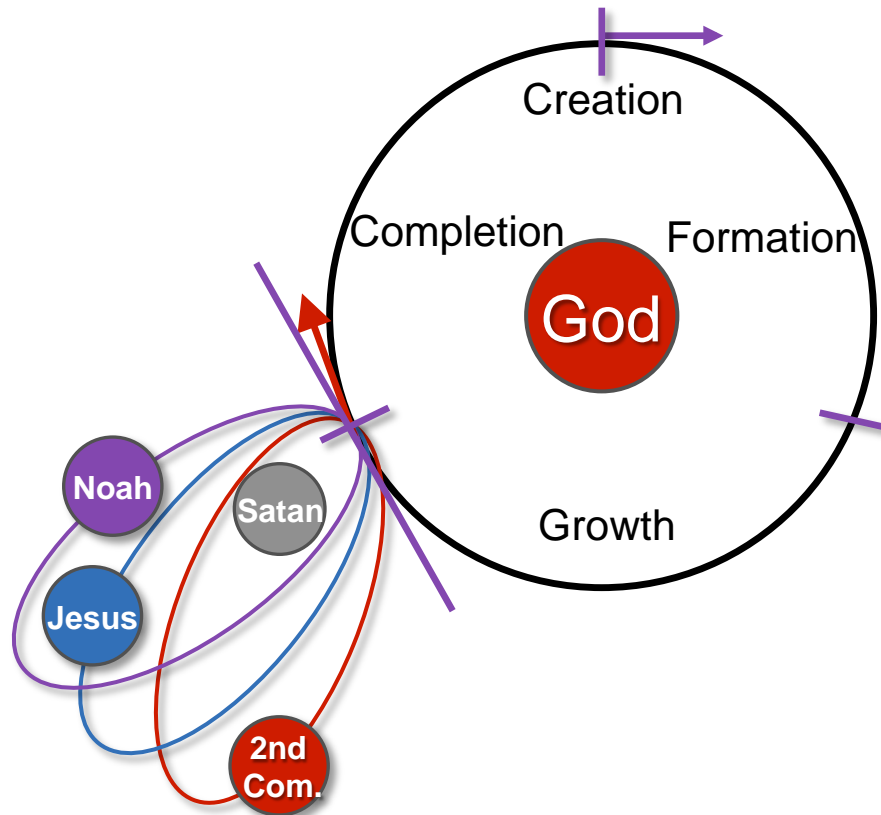

3. Scriptural Verses about Signs of the Last Days

1) The Earth Destroyed (II Peter 3:12-13)

- (1) Earth
- Literal?
 - i. Noah: Genesis 6:13 (I will destroy them with the earth) ✘
 - ii. Jesus: II Peter 3:12 (the elements will melt with fire) ✘
 - iii. 2nd Coming: II Peter 3:13 (we wait for new heavens and a new earth) ✘
 - iv. The earth remains forever:
 - Ecc 1:4 A generation goes, and a generation comes, but the earth remains for ever.
 - Isa 66:22 For as the new heavens and the new earth which I will make shall remain before me.
 - Symbolic?

Matt 6:9 Our Father, who art in heaven...
 John 3:13 ...he who descended from heaven, the Son of man...

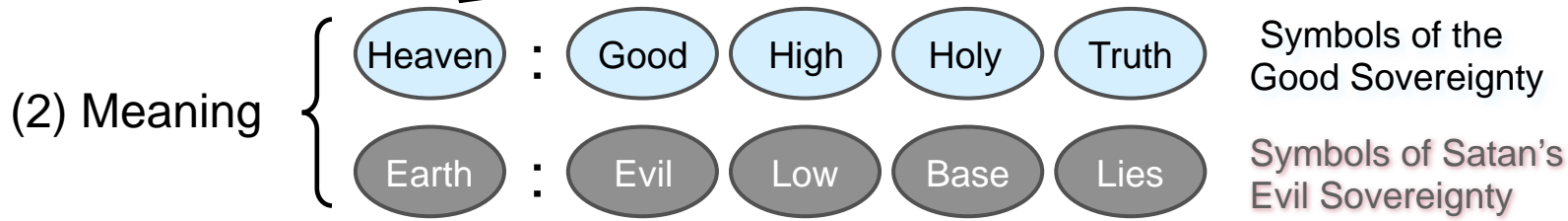

Destruction of the earth = Satan's evil sovereignty destroyed

2) Rising to Meet the Lord in the Air (I Thess 4:17)†

“...shall be caught up together with them in the clouds to meet the Lord in the air.”

(1) Rising up in the air { Literal?
Allegory : symbolic?

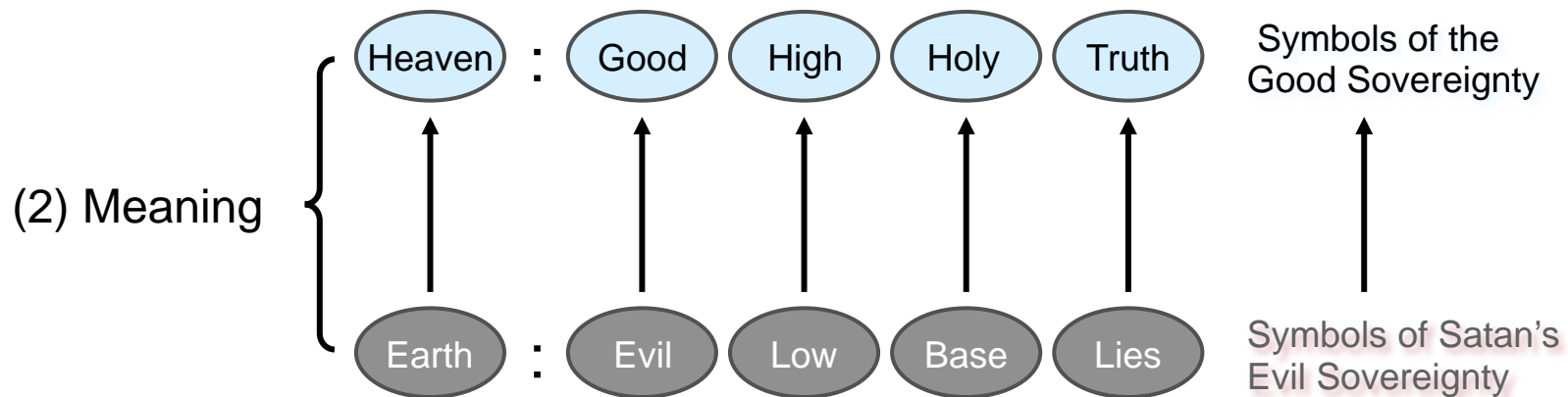

Rising up in the air = a paradigm shift, changing
fundamental sense of values

3) Judgment by Fire (II Peter 3:12)

- 1) Fire { Literal? { i. Jesus: Mal 4:1 (...so that it will leave them neither root nor branch...) ✘
ii. Second Coming: II Pet 3:12 (...the elements will melt with fire...) ✘
Allegory : symbolic?

2) Meaning

James 3:6 The Tongue = Fire

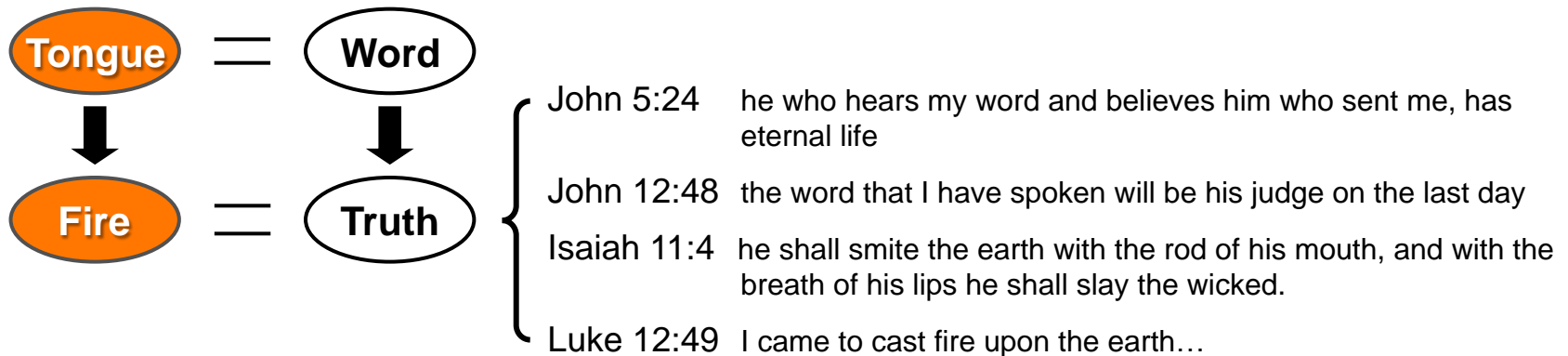

Judgment by Fire = Judgment by Truth

4) Sun, Moon, Stars

Matthew 24:29 ...the sun will be darkened, and the moon will not give its light, and the stars will fall from heaven, and the powers of the heavens will be shaken.

1) Sun, Moon, Stars { Literal?
Allegory : symbolic?

2) Meaning Gen 37:9-10 ...the sun, the moon, and eleven stars were bowing down to me.

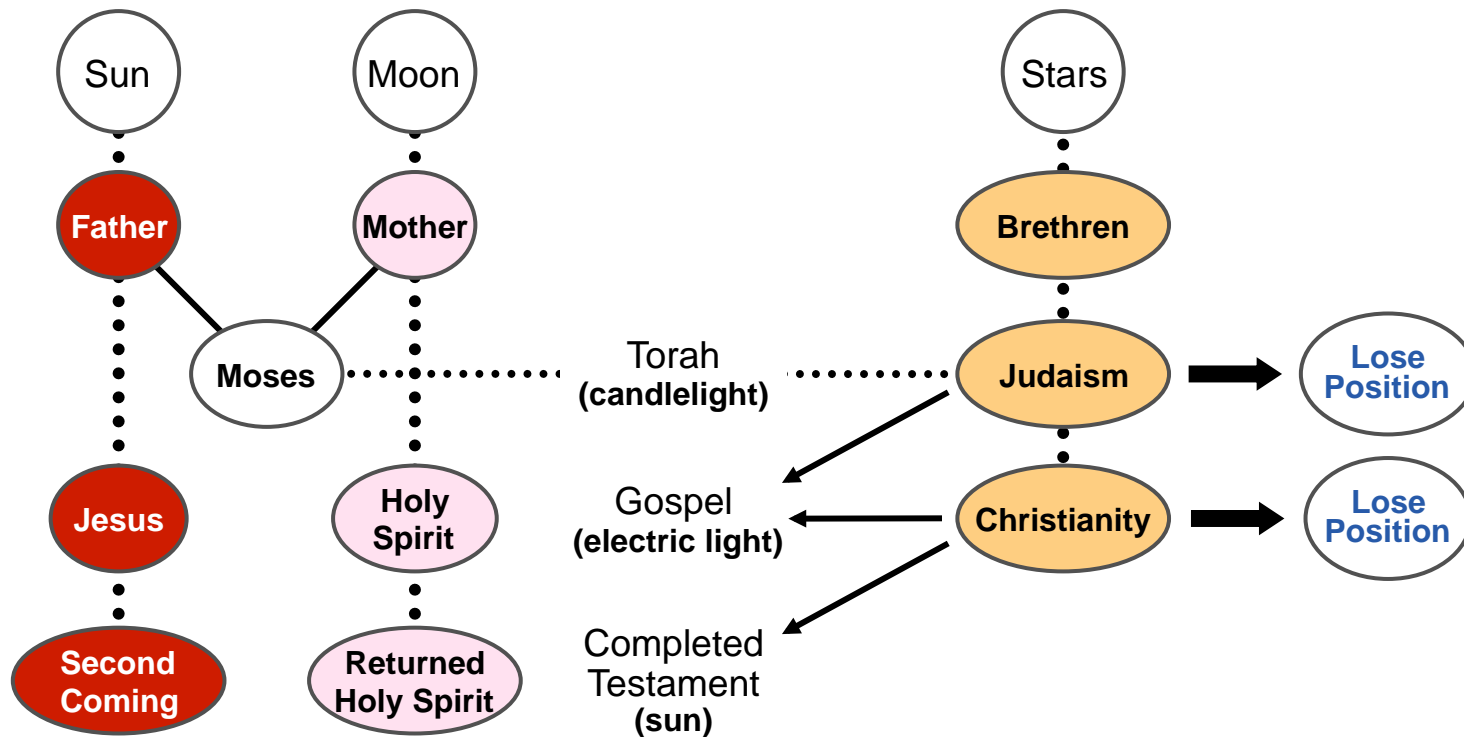

Be darkened = Foreshadows the end of the mission of the teaching
 Stars falling = Foreshadows possible failure if providential responsibility not fulfilled

4. Our Present Time is the Last Days

Matt 24:32 'fig leaves'

1) Perspective 1: From Restoration of the Three Blessings

(1) Indications that the First Blessing is being restored (Perfection of the Individual)

Original World of Creation	Indications	Current Times
Oneness of <i>shimjung</i> (direct communication b/n God and Humans)	Recovery of spirituality	Increasing number of clairvoyants, spiritualists
Freedom of the original mind	Recovery of the original mind's freedom	Pursuit of original freedom Revolution of society in pursuit of freedom
Noble, worthy; Cosmic value	Restoration of the original value of human beings	Groundswell towards democracy; pursuit of the value of individuality; movements for securing human rights (liberation)
World bound together through the love of God	Restoration of original love	Philanthropy; pursuit of true nature of love

(2) Indications that the Second Blessing is being restored (Perfection of the Family)

	Original World of Creation	Current Times
History of the development of cultural spheres	One world family centering on God	One cultural sphere centering on Christianity
History of the rise and fall of nations	World of God's Sovereignty	Democratic world & communist world Division → Unified World

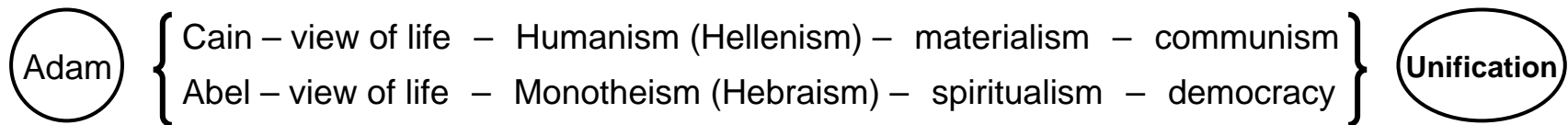

(3) Indications that the Third Blessing is being restored (Restoration of Governance)

{

 Internal – Religion, Philosophy, Ethics – Restoration of Spirit – Conservation of Nature
 External – Scientific and Technical Development – Economic Growth – Comfortable Environment

Conclusion: Signs that the Three Blessings are being restored indicate to us that our current times are the Last Days.

2) Perspective 2: From Social Phenomena

1) You reap what you sow.

Fall of Adam and Eve in the Garden of Eden → Illicit sexual relationship

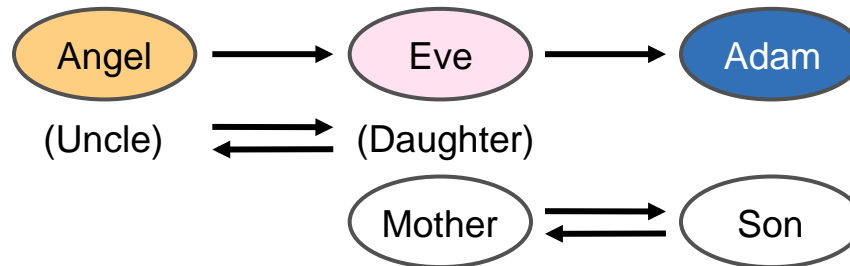

2) Close correlative relationship → Incestuous relationship

Phenomena in society indicate to us that our current times are the Last Days.

5. Our Attitude and The Last Days



1) The Final Days: Liquidation of the old era → Start for the providence of the new era

2) Chaos & Confusion
(Conflict & Contradiction) [Internally: anxiety · dread · chaos & confusion
Externally: discord · struggle

3) Our Stance and Attitude

- (1) With a humble heart and mind, we should make the utmost effort to perceive God's mystical presence through prayer.
- (2) We must not fixate or cling to conventional concepts but rather endeavor to be receptive to God's spirit and guidance.
- (3) In this way, we must seek the new expression of truth that can guide us to the providence of this new era.

- End -

The Advent of the Messiah and the Purpose of the Second Coming

Introduction

'Messiah' is a Hebrew word that means "the one anointed", in particular signifying a king. The chosen people of Israel believed in the Word of God as revealed through the prophets, which promised that God would send them a savior as king who would bring salvation to Israel. This belief became the messianic thought of Israel. God sent this Messiah in the person of Jesus Christ. Here, the expression 'Christ' is the Greek word with the same meaning as 'Messiah', and is generally understood to signify the Savior.

1. The Providence of Salvation through the Cross

Christ → Savior → Jesus – at age 33 (†) resurrected and ascended to heaven.
 Christianity → Church of the Cross → Faith in the cross (salvation through the blood)

1) The Purpose of Jesus' Coming as the Messiah

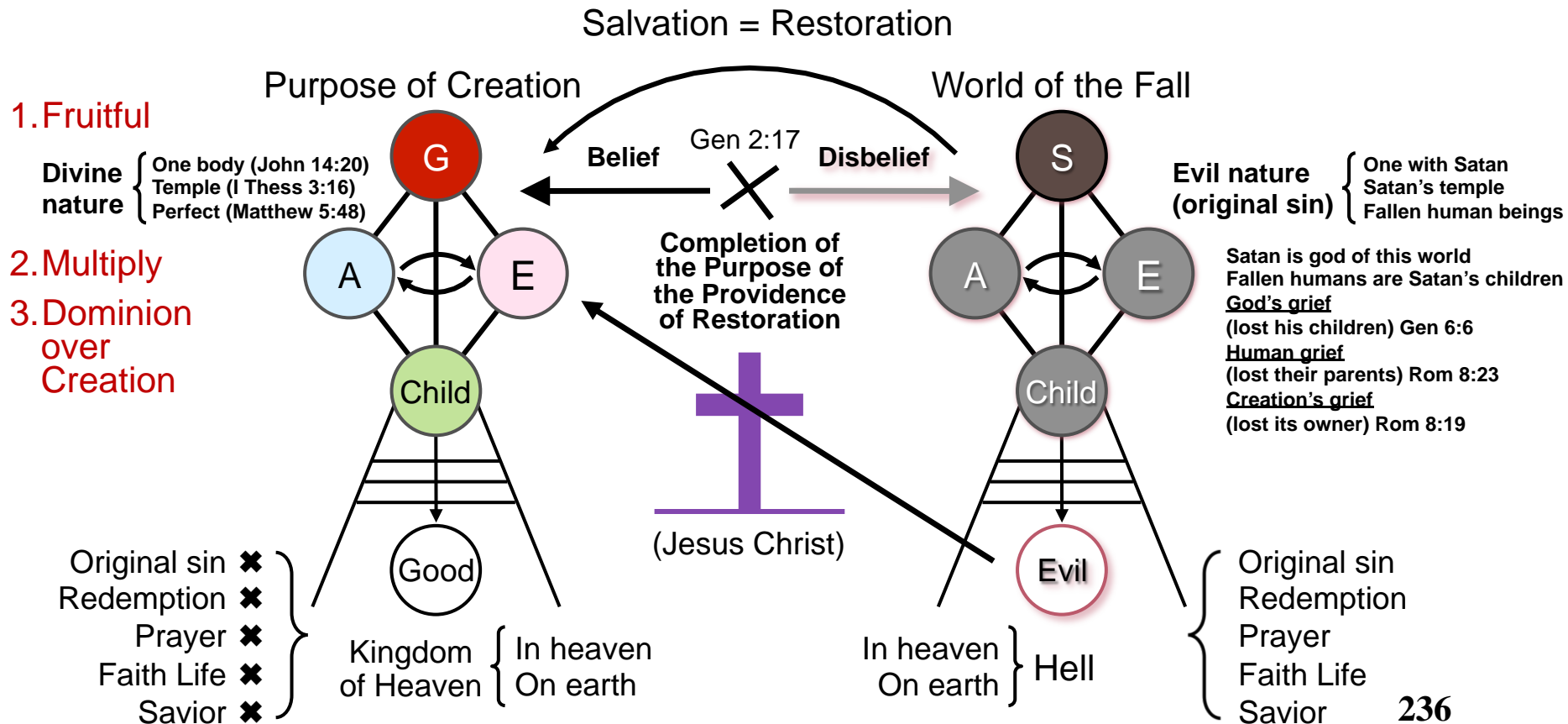

2) Was the Providence of Salvation Completed through the Redemption of the Cross?

(1) Conclusion: The providence of salvation was not completed.

(2) Why was it not completed?

→ Because Jesus Christ died on the cross

(3) The purpose of the providence of salvation was not accomplished.

- Liquidation of original sin ✘ (Rom 7:23, I John 1:8-10)
- Restoration of original human nature ✘
- Prayer, faith still required for indemnity (I Thess 5:17)
- Descendants still need salvation, life of faith (Rev 22:14)

3) Was Jesus' Death on the Cross a Pre-determined

Outcome?
(1) From the perspective of God's providence

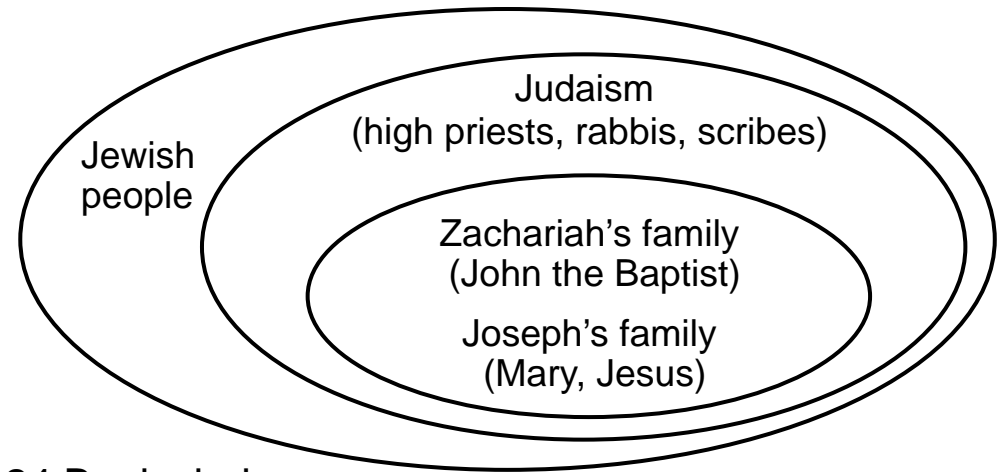

(2) **Jesus' words and deeds**

(John 6:29, John 10:38)

authority to do miracles → Matt 12:24 Beelzebub

(3) **Heart of indignation**

{ Matt 23:37 'as a hen', John 5:39-40 'you study the scriptures'

{ John 5:43-46 'in my Father's name', Matt 23:36 foretells of wrath

(4) **Testimony of the Disciples**

{ Stephen: (Acts 7:52-53 And they killed those who announced beforehand the coming of the Righteous One, whom you have now betrayed and murdered, you who received the law as delivered by angels and did not keep it.)

{ Paul: (I Cor 2:8 None of the rulers of this age understood this; for if they had, they would not have crucified the Lord of Glory.)

Jesus' death on the cross = the result of ignorance and disbelief
Jesus' death on the cross was not a pre-determined fact.
We receive a "limited salvation".

4) The Limits of Salvation through the Cross and the Purpose of the Second Coming of Christ

If faith in Jesus prevailed

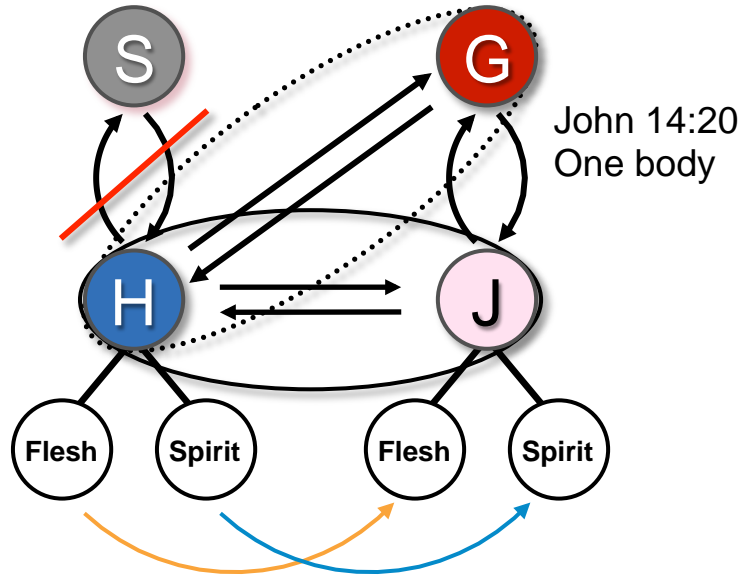

(Isa 9:6, Matt 16:27)†

If disbelief in Jesus prevailed

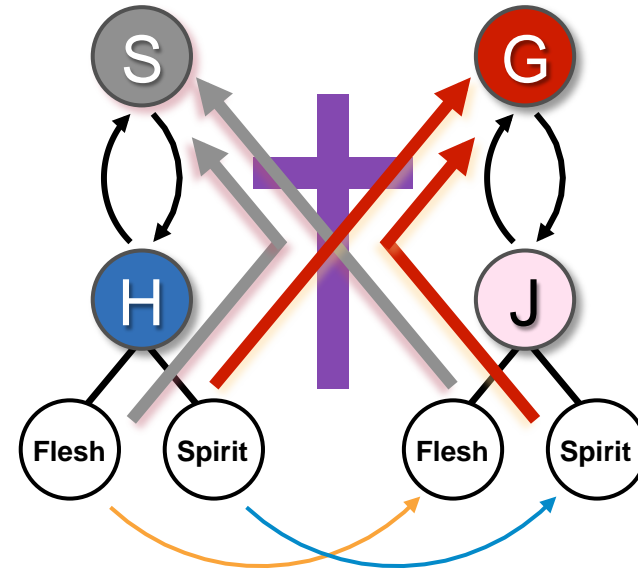

(Rom 7:23, I John 1:8-10, 1. Thess 5:17)†

Physical body invaded by Satan	→	Physical salvation failed	} →	Christ returns to complete salvation of both the spirit and flesh.
Foundation for spiritual victory formed	→	Spiritual salvation completed		

5) Dual Prophecies Concerning the Cross

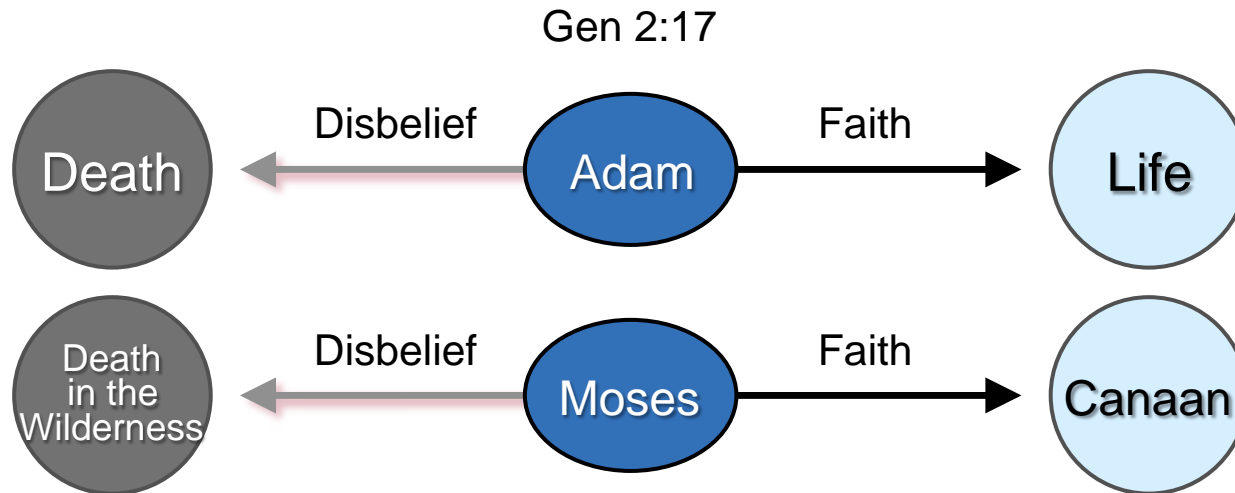
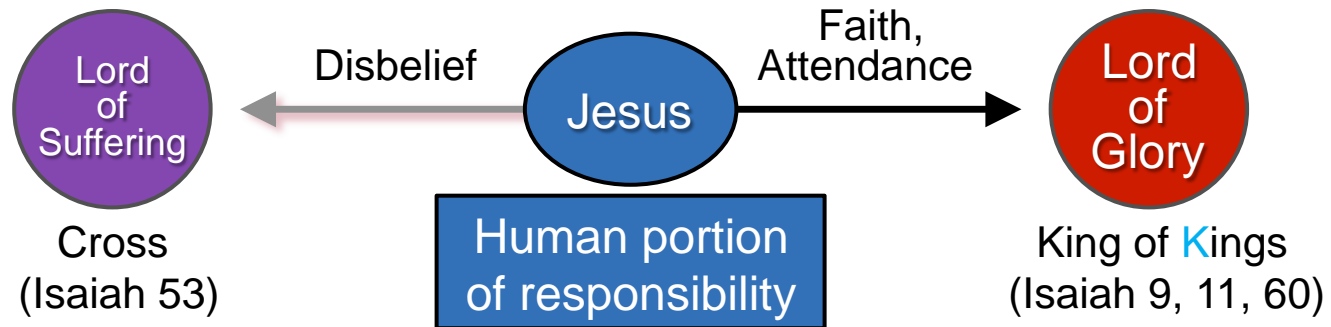

6) Elucidating Passages in Scripture which Appear to Indicate that the Crucifixion was Inevitable

(1) John 3:14

And as Moses lifted up the serpent in the wilderness, so must the Son of man be lifted up...

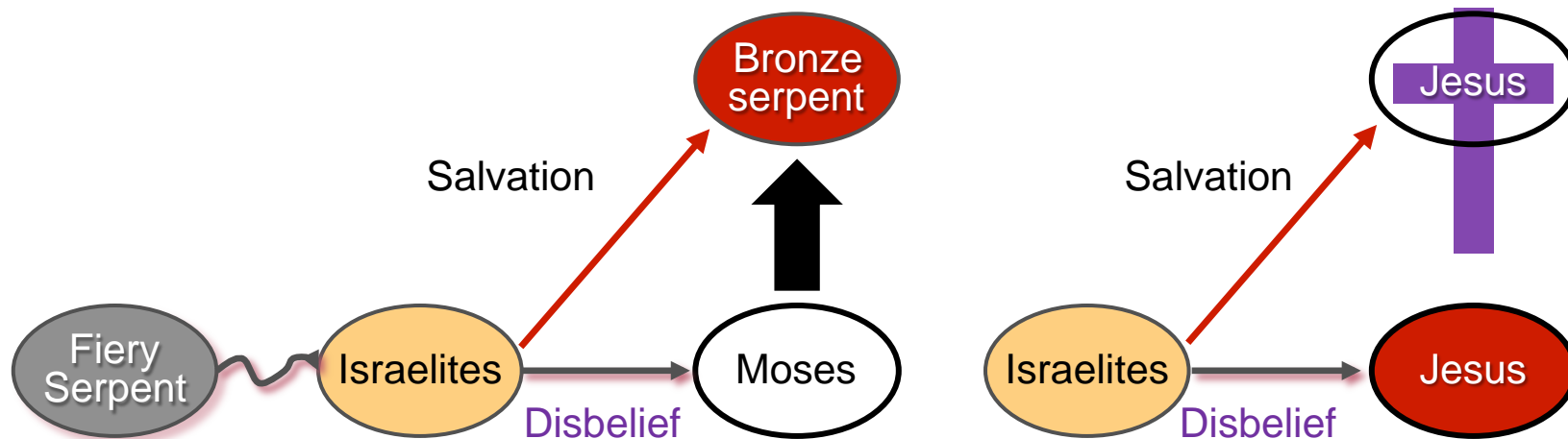

(2) **John 19:30 “It is finished”**

Jesus asked his disciples “Who do men say that I am?”

Simon (Peter) said “The Son of God.”

However, Peter betrayed Jesus in the courtyard of Caiaphas’ house.

(Luke 23:43) { The thief on Jesus’ left did not have faith.
The thief on Jesus’ right acknowledged Jesus as
the Messiah → Paradise.

Meaning of the words “It is finished”:
i. Received testimony as the Messiah
ii. Accomplished spiritual salvation

These words by Jesus do not mean that
he accomplished the entire Will of God.

(3) Matt 16:23 Jesus words to Peter: “Get behind me, Satan!”

Luke 9:30 “And behold, two men talked with him, Moses and Elijah, who appeared in glory and spoke of his departure, which he was to accomplish at Jerusalem. Now Peter and those who were with him were heavy with sleep, and when they wakened they saw his glory and the two men who stood with him. And as the men were parting from him, Peter said to Jesus, ‘Master, it is well that we are here; let us make three booths, one for you and one for Moses and one for Elijah’ - not knowing what he said.”

At this time, it was decided to forgo physical salvation, pursue the path of spiritual salvation and that Jesus’ body would go to the cross.

Satan then entered Peter with the intention of blocking even the way to spiritual salvation.

In the end, Satan enters Judas to betray Jesus.

Conclusion

Jesus did not come in order to die on the cross. Rather, his death on the cross was a result of the disbelief of the Jewish people and the faithlessness of his disciples.

2. John the Baptist and the Second Coming of Elijah

1) The Direction of the Mind of the Jewish People

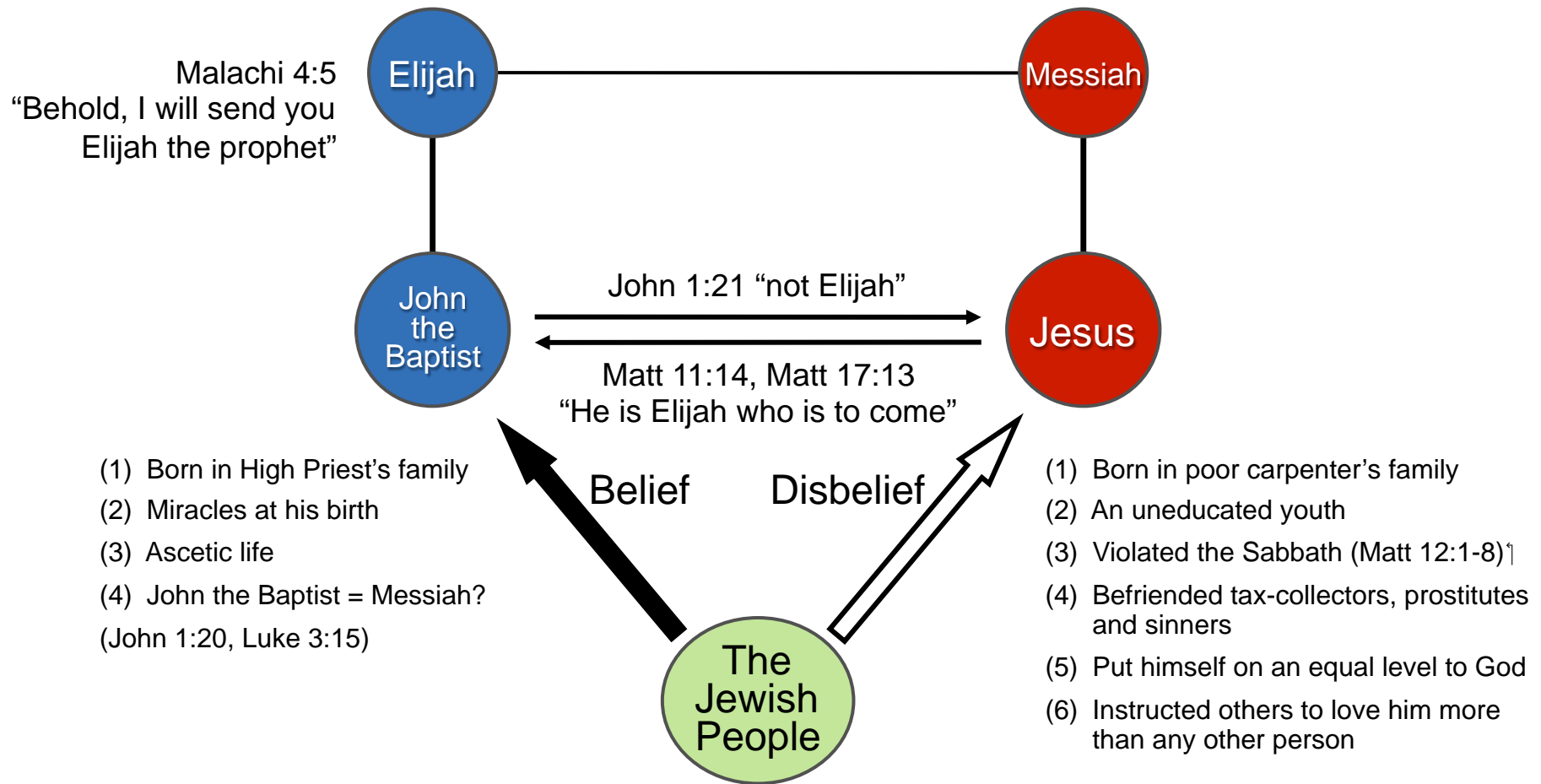

(The path the Jewish people would go)

2) The Mission of John the Baptist

(1) The Mission to Testify { John 1:23 : 'Make straight the way of the Lord'
John 1:33 : Testify to Jesus at the Jordan river

(2) The Mission to Attend: "...to serve him ... in holiness and righteousness before him all the days of our life." Luke 1:75

Disbelief of
John the Baptist



Disbelief of the Jewish
people as a whole



The Crucifixion
of Jesus

3) Causes behind the Disbelief of John the Baptist

- (1) Ignorance concerning God's Will and providence (Matt 11:17)
- (2) Evaluated Jesus from his own viewpoint
- (3) Mistaken view of what the Messiah is
- (4) Lack of faith in Jesus' words and deeds
- (5) Worried about his social prestige, reputation
- (6) Believed the Old Testament in a literal way

4) Christ's Reproaches towards John the Baptist

"Among those born of women there has risen no one greater than John the Baptist. Yet even the least in the kingdom of heaven is greater than he." Matt 11:11

5) Conversations between John the Baptist and the Disciples

- (1) In relation to Jesus, John the Baptists says “He must become greater; I must become less.” (John 3:22-30)

Many saints have understood these words to show how both humble and great John the Baptist was. This viewpoint, however, comes from a misinterpretation of the scripture. Actually, if the teacher is to increase, then his disciple and follower will also increase. Thus, these words by John indicate that he had chosen to go a path different from the path of Jesus.

- (2) “When John, who was in prison, heard about the deeds of the Messiah, he sent his disciples to ask him, “Are you the one who is to come, or should we expect someone else?” (Matt. 11:2-3) In response to this, Jesus replied, “Go back and report to John what you hear and see: The blind receive sight, the lame walk, those who have leprosy are cleansed, the deaf hear, the dead are raised, and the good news is proclaimed to the poor. Blessed is anyone who does not stumble on account of me.” (Matt. 11:4-6)
- (3) Observing how the ruler of Israel, Herod, had married his younger brother’s wife, Herodias, John the Baptist said “it is not lawful for you to have your brother’s wife.” In response to this, Herod had John seized and thrown into prison (Mark 6:17-28).

We need to view the Scripture from a new perspective.

6) The Reason why John the Baptist was Elijah

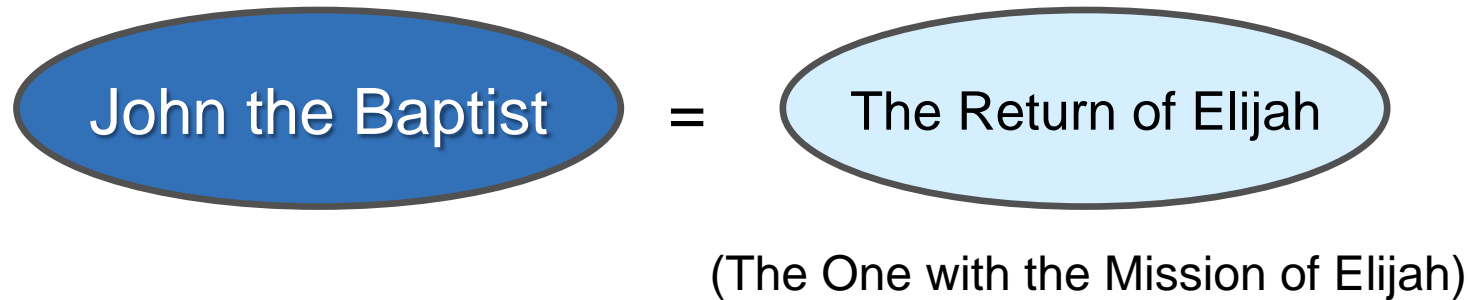

Luke 1:17

“...and he will go before him in the spirit and power of Elijah, to turn the hearts of the fathers to the children, and the disobedient to the wisdom of the just, to make ready for the Lord a people prepared.”

7) Our Attitude Towards the Holy Bible

Heavenly
Secrets



No one knew
these secrets

The ignorance and disbelief of John the Baptist towards Jesus brought about disbelief by the Jewish people, and this disbelief by the Jewish people is what eventually forced Jesus to walk the path of the crucifixion.

Why? Because we have always read the Bible based on the predication that John the Baptist is and was unconditionally a great and successful prophet.

- (1) We have to put aside and separate ourselves from conventional customs and concepts of faith based in habit.
- (2) We have to consistently invest ourselves to practice a faith that is internally correct in both spirit and in truth.

Resurrection

Introduction

If we accept the prophecies of the Holy Scripture literally, we have no choice but to expect that when Jesus returns, the bodies of all the saints who have already died, who were buried and whose flesh has decomposed, will come back to life with their bodies reconstituted to their original state (I Thess. 4:16, Matt. 27:52).

Do we have to believe in these prophecies literally? To answer this question, we must first of all examine the true meaning of resurrection.

1. The Meaning of Resurrection

- 1) General View of Life and Death { Life = The functions of the physical body are active.
 Death = The functions of the physical body cease; the body is a corpse.
- 2) The Scriptural Concept of Life and Death

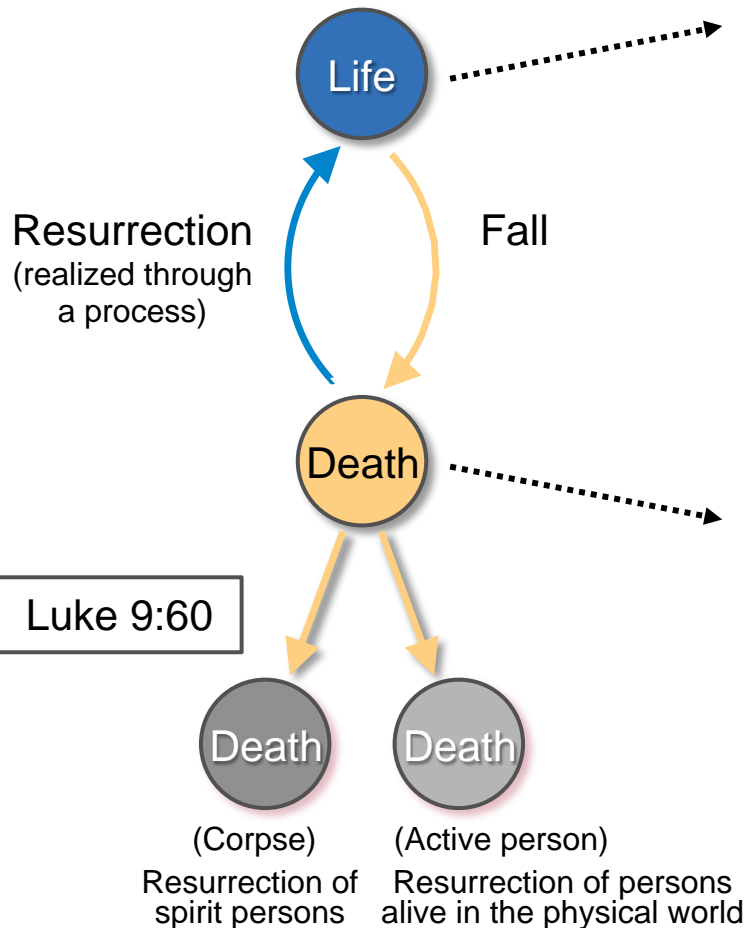

One in heart with God (*Shimjung ilche*)
 (God's love is the source of life, state of dwelling within God's true love)

John 11:25 'he who believes in me – shall live, whoever lives and believes in me – shall never die'
 John 5:24 "he who believes has – eternal life' (who hears my word and believes in him who sent me)

State where the *shimjung* relationship with God has been severed
 (Departed from the realm of God's love, State of dwelling under Satan's sovereignty, where true love is unavailable)

Rev 3:1 'name of being alive – but dead'
 I John 3:14 'he who does not love – abides in death'
 Rom 6:23 'wage of sin – death'
 Rom 8:6 'set the mind on the flesh – death' 'set the mind on the spirit – life and peace'

3) The Meaning of Resurrection

As a result of the Fall, human beings fell into a state where they are governed by Satan. Resurrection is the phenomenon and process in which a person is restored from the realm of Satan's control into the realm of God's direct governance by the means of God's providence of restoration. Accordingly, to the extent that I repent of my sins and become a better person than I was yesterday, that's the extent to which I have resurrected.

4) What Kind of Changes does Resurrection bring about in Human Beings?

{ Outwardly - No significant change
Internally - Spiritual change (from dwelling of Satan to a temple of God)

E.g.) The disciples of Jesus

There was no external change from before they became disciples.

5) The Death Caused by the Human Fall

The reason we need resurrection is because of the death caused by the Fall. What then is the death that was caused by the Fall of the first human ancestors?

- (1) Gen 2:17 "...in the day you eat of it (the tree of the knowledge of good and evil), you shall surely die."

These words in scripture do not refer to the death of the flesh.

Even after Adam and Eve ate the fruit of good and evil, they bore children and continued to live actively for more than 900 years. This means that the death brought about by the Fall was not the death of their fleshly bodies, but rather was the death of their spirits, as they were separated and severed from the love of God.

Physical death is not a result of the Fall of man.

- (2) According to the Principle of Creation, no physical living being can live on forever.

Consider the fact that God created the spirit world. If the physical body could live forever, there would be no need for God to create the spiritual world in the first place. According to the Principle of Creation, human beings were originally created to grow old and for their bodies to eventually 'return to dust' (Ecclesiastes 12:7).[†]

The death caused by the Fall = falling from the realm of God's governance of goodness into the realm of Satan's evil dominion.

2. The Providence of Resurrection

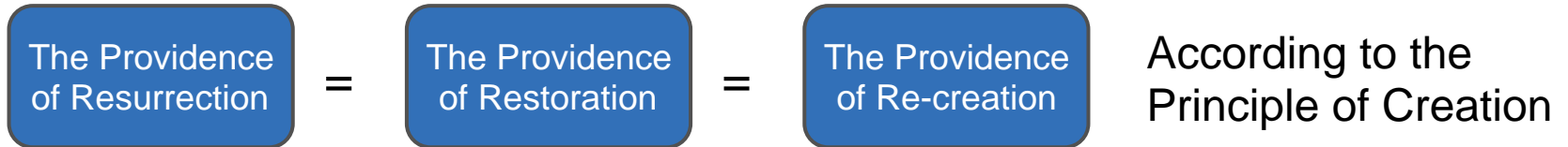

1) The Fundamental Laws of the Providence of Resurrection

(1) Belief in the Word and Practice of the Word

$$\begin{array}{ccccc} \text{Completion of} & & \text{God's} & & \text{Human} \\ \text{the Providence} & = & \text{responsibility} & + & \text{responsibility} \\ \text{of Resurrection} & & \text{(Word)} & & \text{(Belief \& Practice)} \end{array}$$

(2) The Spirit Self grows to completion - on the basis of the physical body.

(3) In accordance with the merits of the era

(4) Resurrection is completed through three orderly stages.

2) The Providence for Resurrection of People on Earth

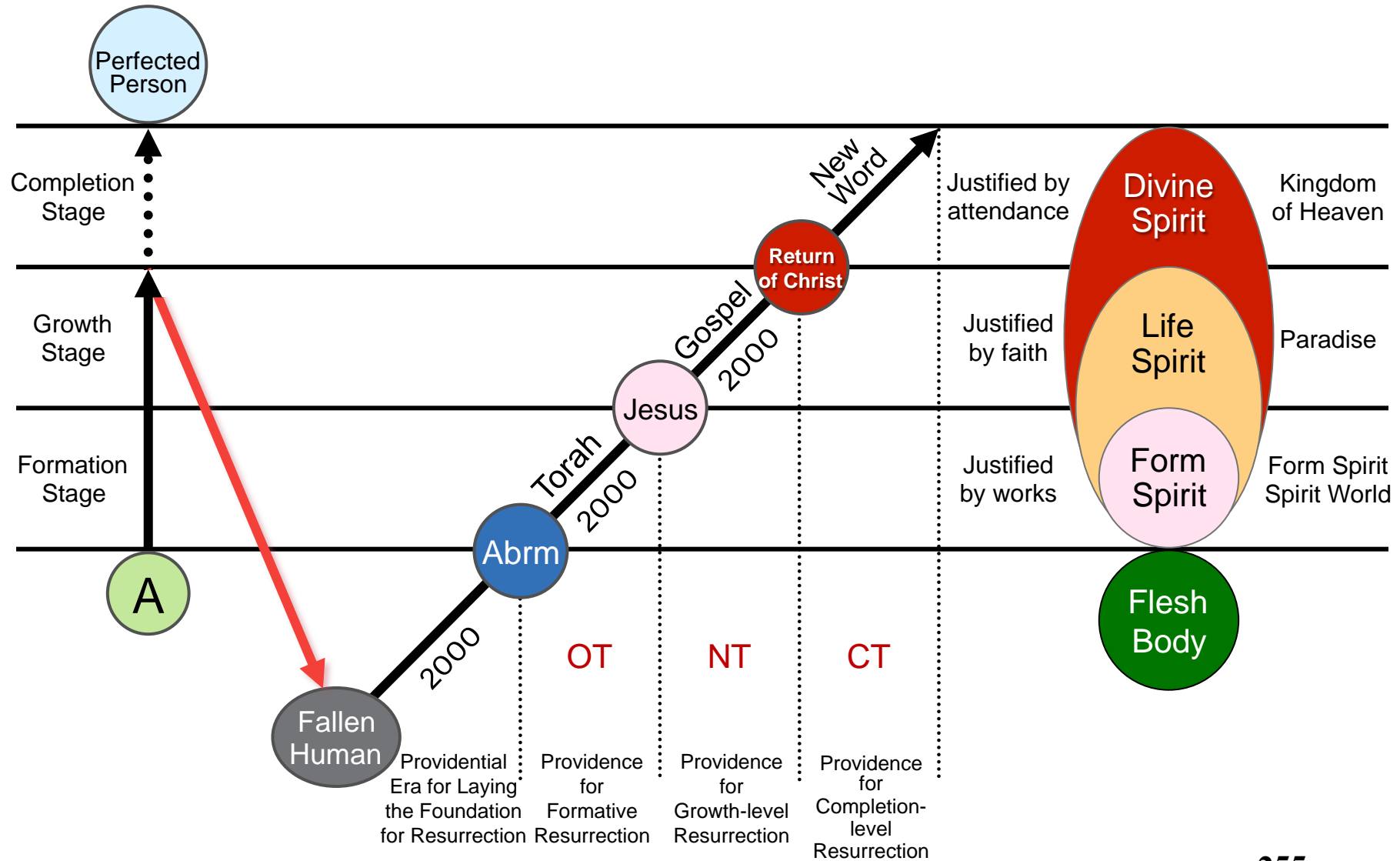

(1) Spiritual Phenomena in the Last Days

Reason that God promised to pour out His Spirit in the last days (Acts 2: 17): The period just before the first human ancestors fell was a time when they could communicate directly with God the Creator. The Last Days is the era when this period is restored all around the world.

- i. “You are the Lord” { Rulers of Creation
Persons assigned the mission to represent the Second Coming of the Lord in that era
- ii. “You are the best”
The spiritual standard of each individual varies, with the result that the level of spirit world that each person can communicate with differs accordingly.
 - a) Focused only on their individual vertical relationship with God; not aware of the horizontal relationships between them. This is the reason why a spiritually communicating person may receive the revelation that ‘you are the best’.
 - b) The meaning of the revelation is that this person is the best one suited for their particular field of activity; it is not meant ‘in reference to all human beings’.
- iii. Spiritually sensitive people will encounter confusion and trials due to conflicting views between them.

(2) The First Resurrection (the sealed 144,000)

The ‘first resurrection’ refers to the resurrection in which human beings are cleansed of the original sin for the first time since God began the providence of restoration. This will be accomplished through the grace and work of the Second Coming and will allow human beings to restore their original selves and fulfill, for the first time, the purpose of God’s creation.

$$12 \times 12 = 144,000$$

3) The Providence for Resurrection of Spirit Persons

- 1) Reason for this providence
 - i. The spirit self can only grow and reach completion through a relationship with the physical body.
 - ii. Without a physical body, no resurrection can occur.
- 2) Method of resurrection
Form a standard for interaction with the spiritual activities of people living in the physical world.
- 3) The resurrection of spirit persons who believed in God when on earth

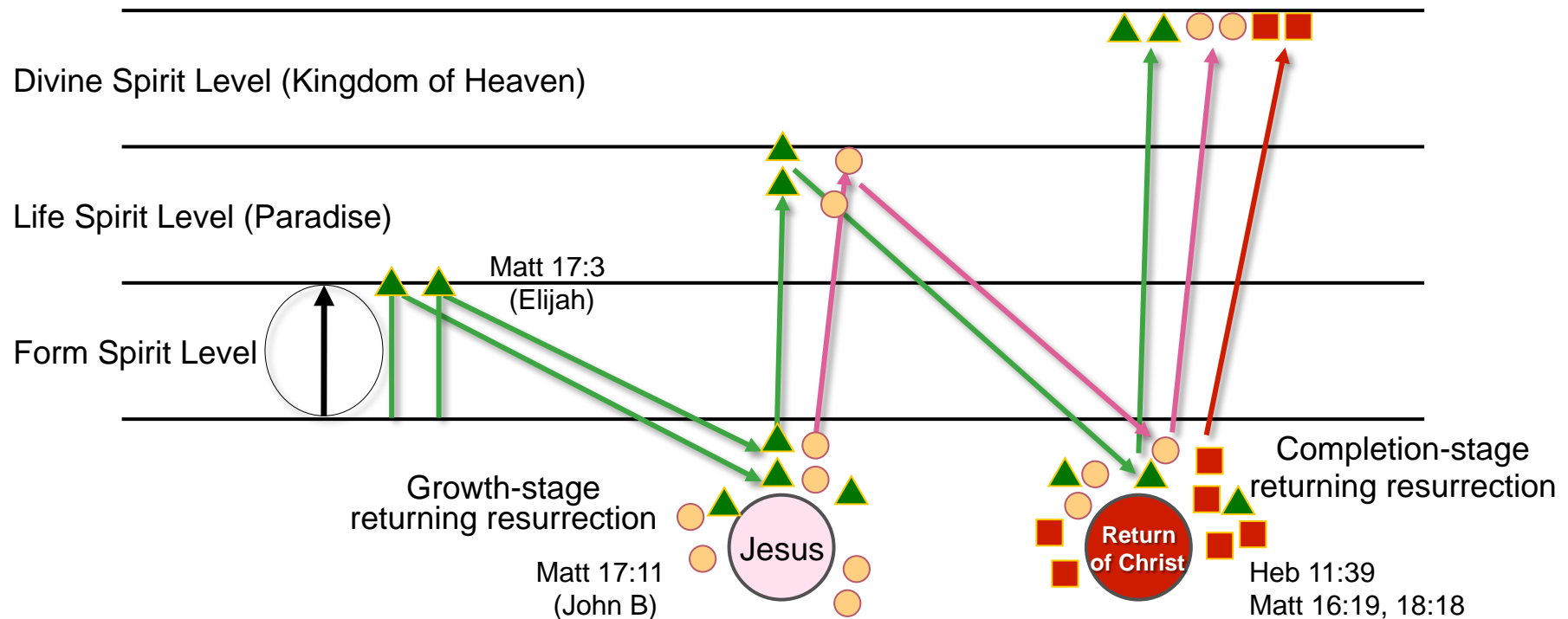

4) Returning Resurrection of Spirits Who Abide Outside Paradise

Spirit world

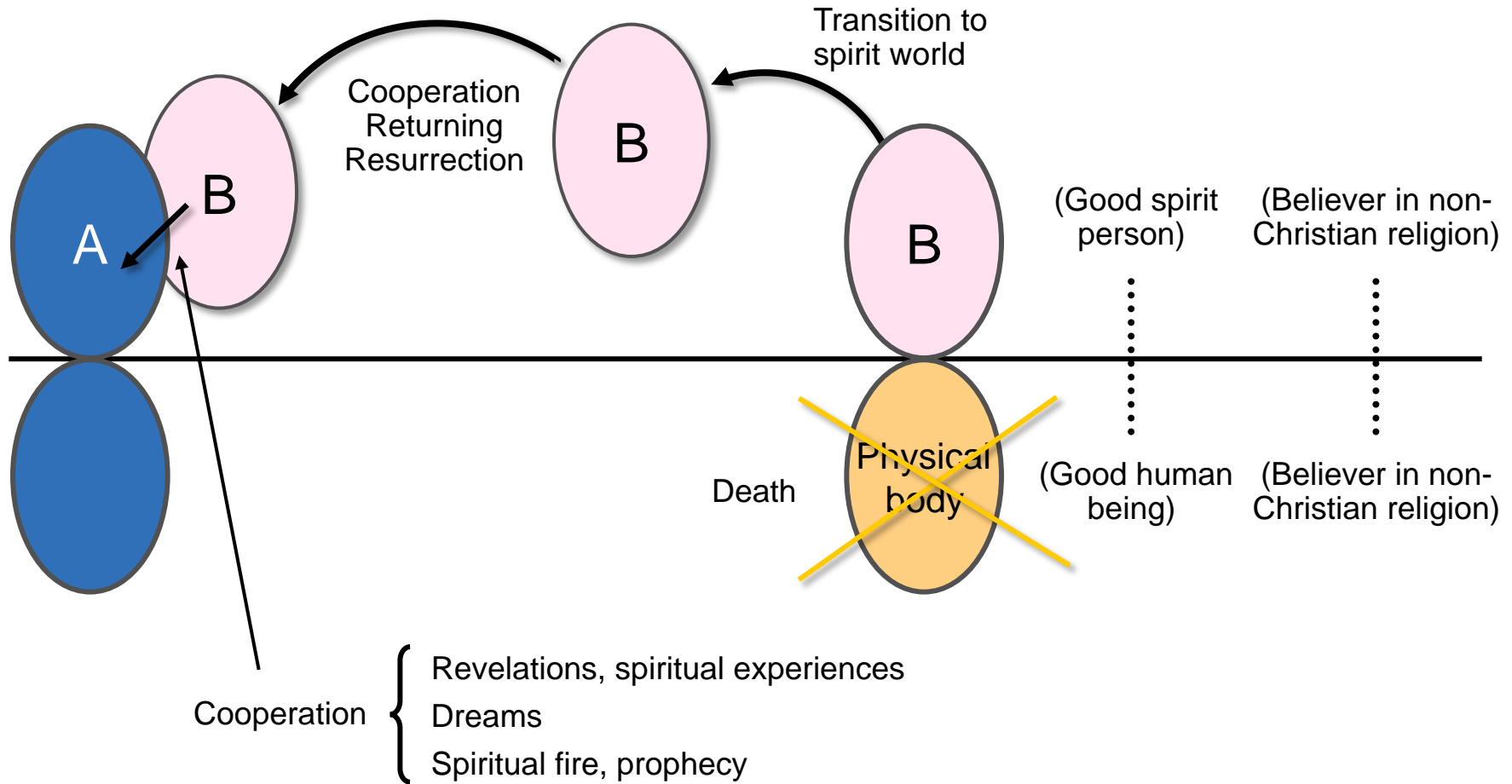

Physical world

(5) The Death Caused by the Human Fall

i. The work of returning resurrection of evil spirit persons

Because evil people transition to the spirit world after sinning during their lives, they are unable to relate directly to God, who is the original substance of goodness. Nonetheless, God must save everyone, even evil spirit people.

In the spirit world, there is no mechanism by which evil spirit persons can indemnify the sins they committed on earth. For this reason, they must establish indemnity conditions on earth to remove their sins. Accordingly, the evil spirit persons set up their indemnity conditions as a punishment for the sins committed by people on earth. From the viewpoint of that person on earth, that condition is a punishment. Accordingly, only when the works of the evil spirit person establishes an indemnity condition for the person on earth to liquidate the sin they have committed does the evil spirit person receive the benefits of resurrection. When they receive the grace of resurrection, they are liberated from the realm of spirit world in which they reside.

For this to happen, the person on earth has to repent of his or her sin, have faith in God and practice good in their daily life. Thus, the work of changing the person on earth is not carried out by God directly, but is carried out by the evil spirit person on behalf of God.

In this way, because the evil spirit person establishes a condition that results in the liquidation of the sins of people on earth, in place of God for the accomplishment of the Will, it becomes possible for the evil spirit person to receive the grace of resurrection.

Because an indemnity condition in the form of a punishment is established to liquidate the sins of people on earth, as per God's desire, the evil spirit persons come to receive the grace of resurrection.

ii. There are two types of returning resurrection work carried out by evil spirit persons.

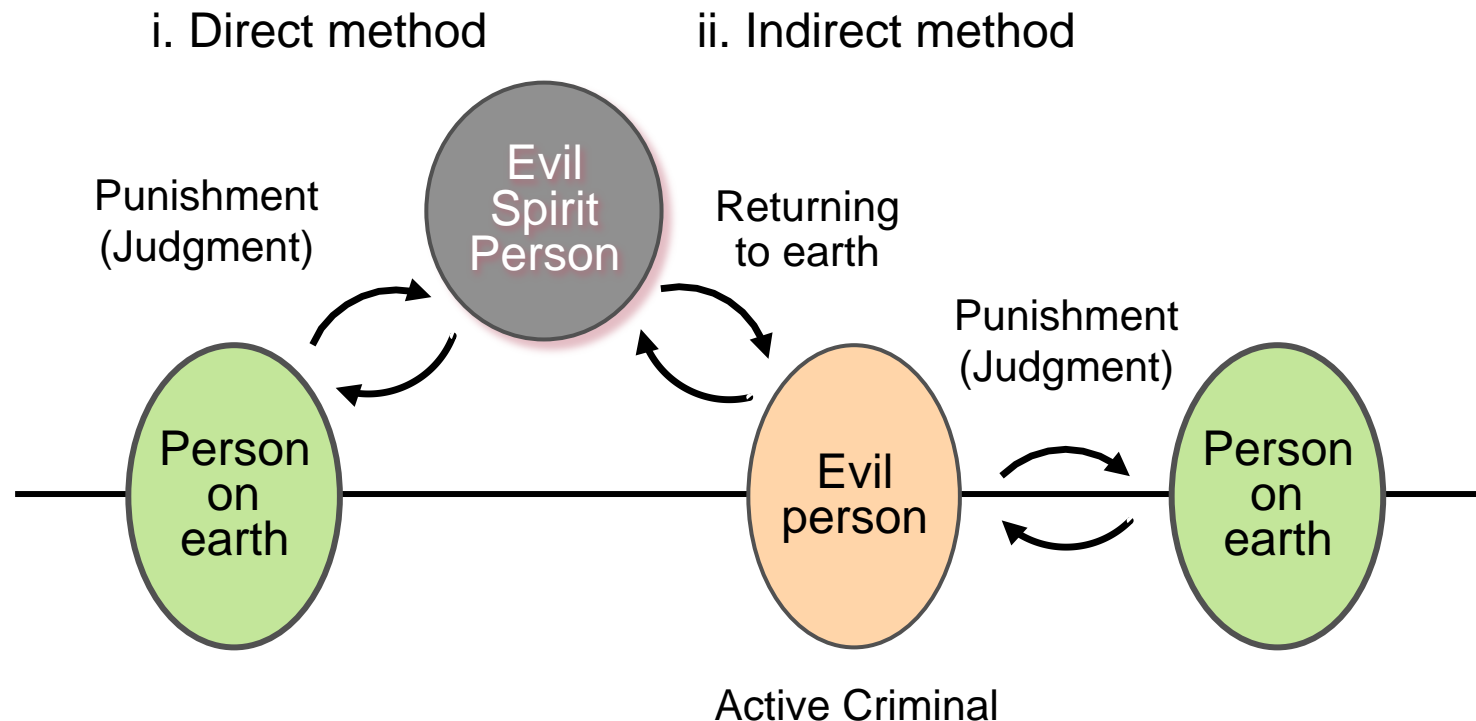

4) The Theory of Reincarnation in Light of the Principle of Returning Resurrection

(1) Returning Resurrection

Spirit persons who were unable to complete their mission during their earthly life must 'return' to people on earth who are similar to themselves and who have the same type of mission. They must then cooperate with those people on earth in order to accomplish God's Will.

In this way, the cooperation helps the person on earth to fulfill his mission as well as the mission of the supporting spirit person. Thus, from the viewpoint of 'mission', the physical body of the person on earth stands in for the body of the cooperating spirit person.

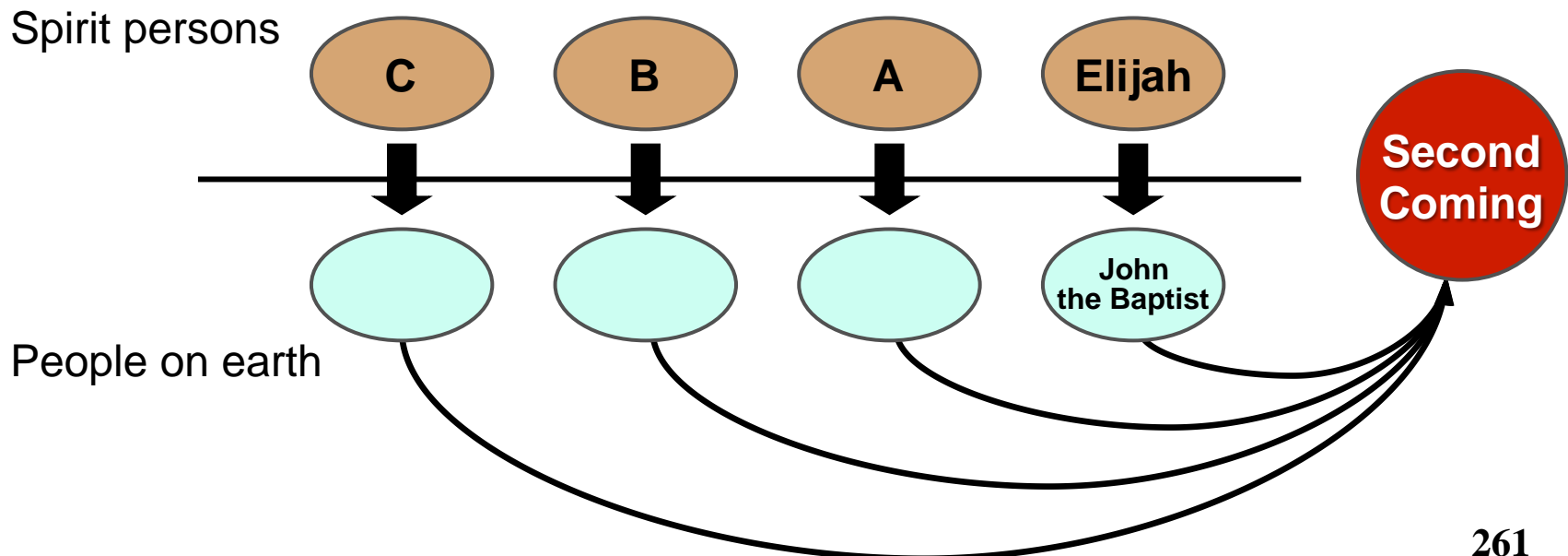

(2) The Theory of Reincarnation

Continuing up to the present day, Buddhism has taught the doctrine of reincarnation and many Buddhist followers have believed that if one lives a good and virtuous life on earth, he or she will be reborn as a human being, but if one lives in an unvirtuous manner, he or she will be reborn as an animal.

This approach to faith is incorrect.

Human beings were created as the children of God, and only human beings have a spirit self. It is incorrect to think that if a person lives in bad way and then departs to the spirit world, that person's spirit self will change from human into an ape or some other animal. The spirit world is a world of light. Hell, the realm of darkness, exists in the lowest realms of the spirit world, and the Kingdom of Heaven, the realm of light, exists at the top.

The spirit persons who reside in Hell do not have a defined or definite form. For this reason, they may appear as animals, depending on what form they take. The idea that human beings reincarnate as animals derives from observation of this reality. From the perspective of the Principle, 'reincarnation' is synonymous with 'returning resurrection'.

3. The Unification of Religions brought about by Returning Resurrection

Spirit persons from different religions

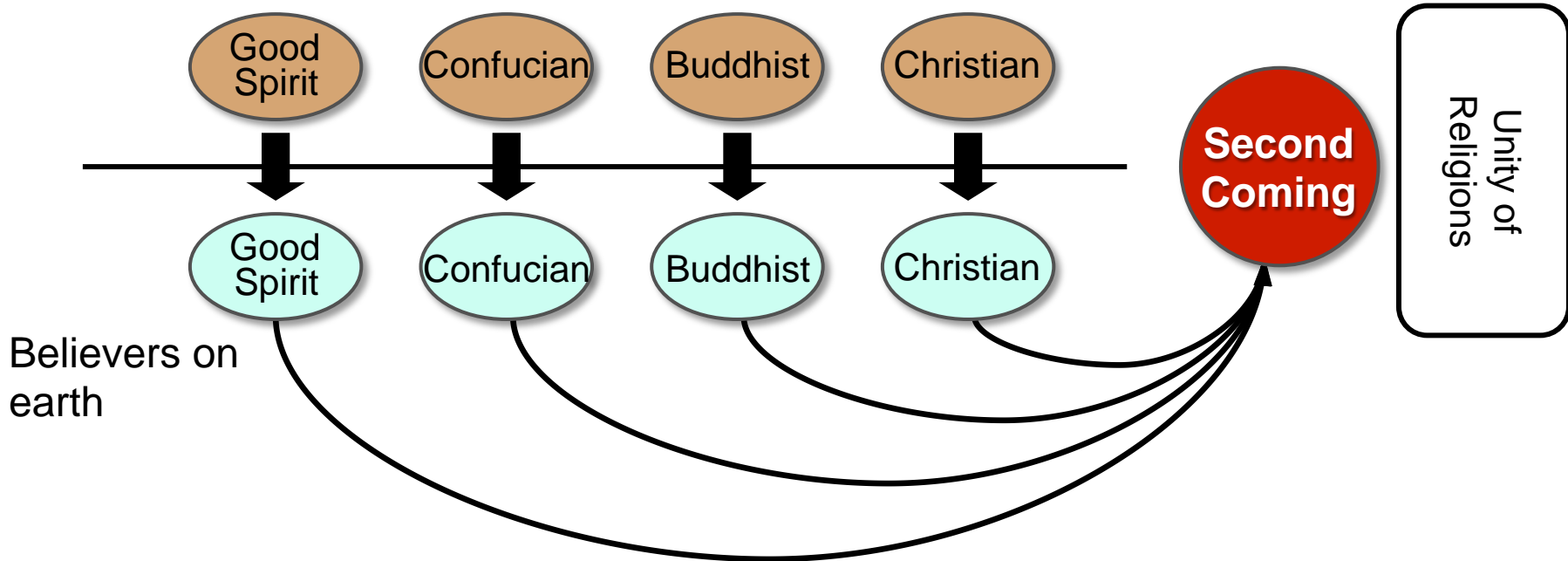

- End -

Predestination

Introduction

The Issue of Predestination

Prosperity and decline in human life, fortune and misfortune
Salvation of damnation of fallen human beings
The rise and fall of nations

For	Against
Rom 8:29~30 Those whom He predestined, He also called...	Matt 7:7 Ask and it will be given to you.
Rom 9:15~16 I will have mercy on whom I have mercy...	James 5:14 Is any one of you sick? He should call the elders of the church to pray over him.
Rom 9:21 Has the potter no right over the clay?	Gen 2:17 But you must not eat from the tree of the knowledge of good and evil.
Rom 9:11~13 Yet, before the twins were born.... "Jacob I loved, but Esau I hated."	Gen 6:6 The Lord was sorry that He had made man on the earth.

1. Predestination of God's Will

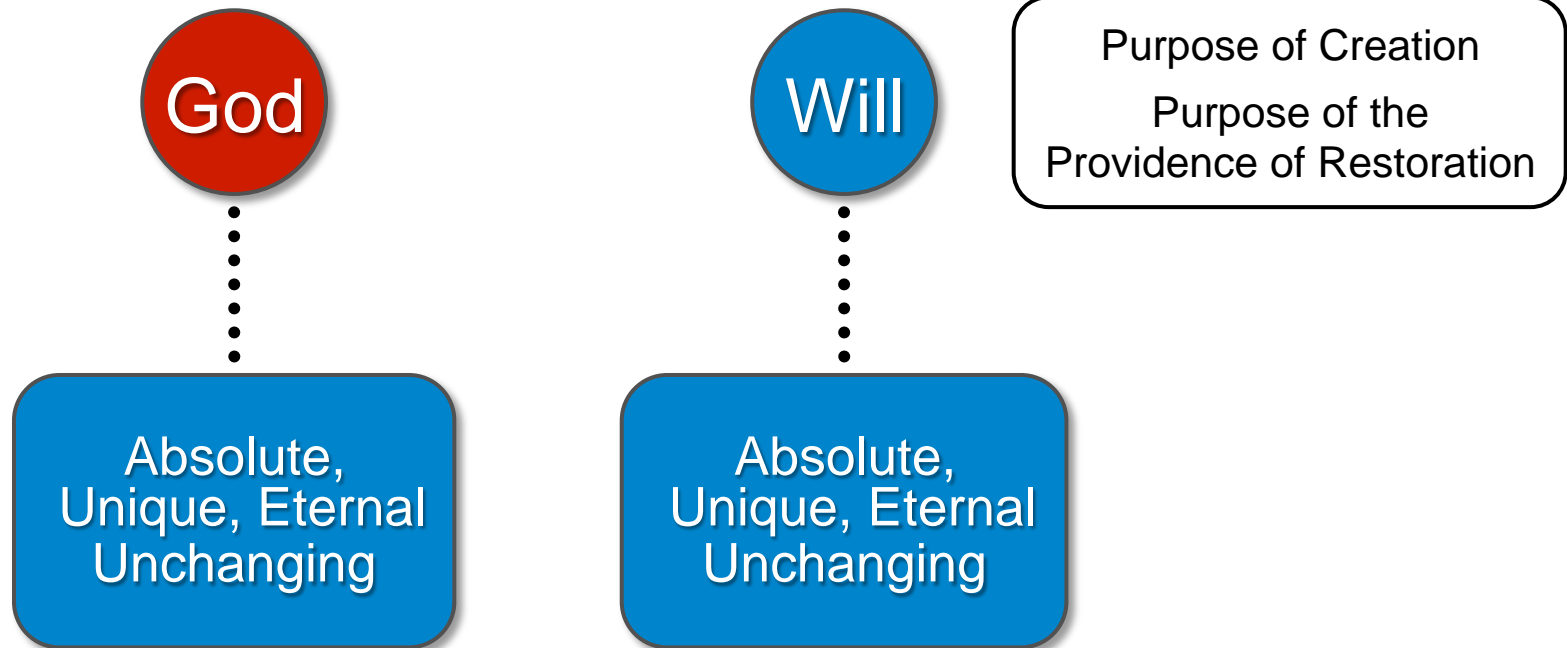

Predestination of God's Will = Absolute

2. Predestination of Accomplishment of God's Will

The Will Absolute

Purpose of Creation
(Providence of Restoration)



Matt 7:7 Ask and it will be given to you

James 5:14 Is any one of you sick? He should call the elders of the church to pray over him

Gen 2:17 But you must not eat from the tree of the knowledge of good and evil

Gen 6:6 The Lord was sorry that He had made man on the earth

Predestination of Accomplishment of the Will = Conditional

3. Predestination of Human Beings



Conditions the Central Figure must possess

- (1) Member of the chosen people
- (2) A descendant of ancestors with a track record of many good deeds
- (3) Innate disposition
- (4) Conditions formed during life
- (5) The time and place required by Heaven

Human Responsibility

- Fulfilled → Predestined individual completes mission → Will Accomplished ✓
- Unfulfilled → Predestined individual fails mission → Will Not Accomplished ✗

Example: Acts 1:15~26 Judas Iscariot → Matthias

Predestination of Human Beings = Conditional

4. Explanation of Biblical Verses that Underlie the Concept of Predestination

Rom 8:29~30

This verse omits any reference to the human portion of responsibility.

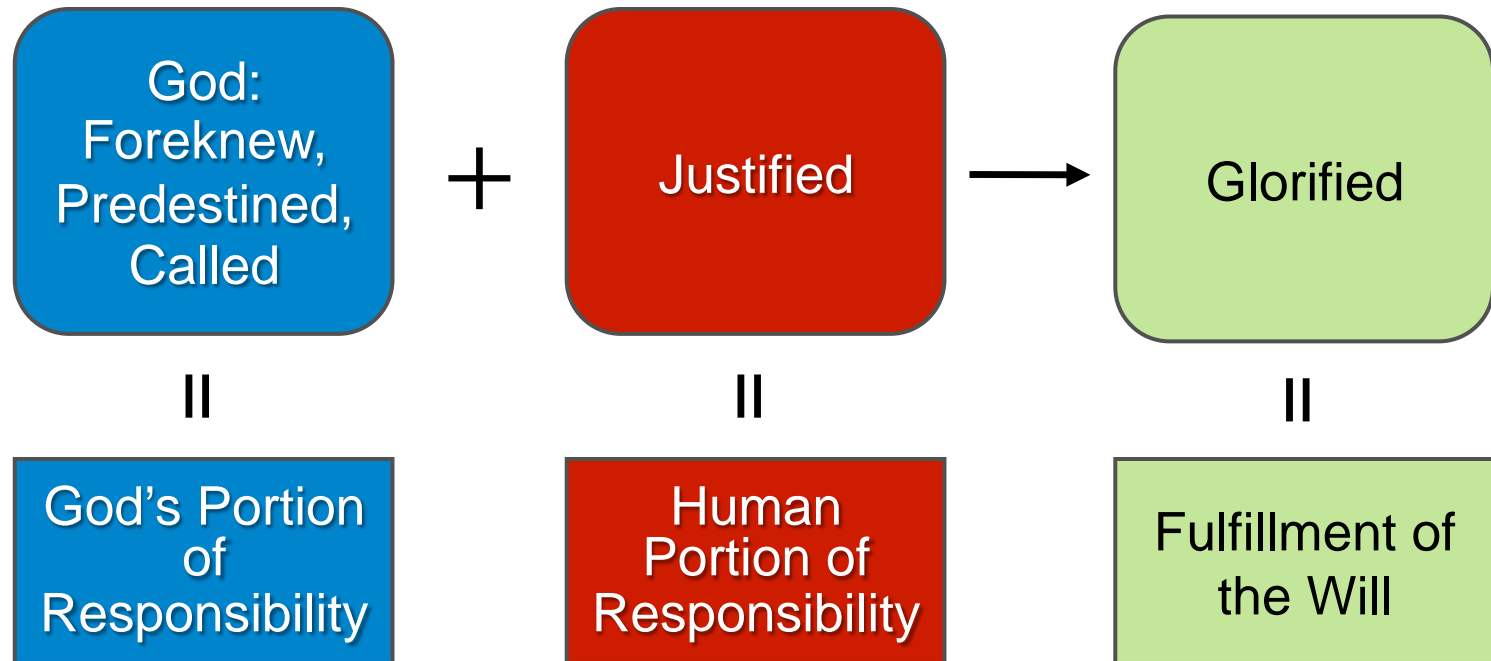

- 1) **Rom 8:29~30** “For those whom He foreknew He also predestined...”
 An individual is predestined to be glorified by God only when that individual fulfills his responsibility. Because the scripture verse omits any reference to the human portion of responsibility, people have interpreted as signifying that God’s glorification depends only on His absolute predestination, and nothing else.
- 2) **Rom 9:15~16** “I will have mercy on whom I have mercy...”
 This scripture was given in order to emphasize God’s complete authority and grace.
- 3) **Rom 9:21** “Has the potter no right over the clay...”
 This scripture has the purpose of teaching us that, because human beings fell and became like garbage, fit to be thrown away, we have no right or basis to complain, regardless of how we are dealt with by God.
- 4) **Rom 9:11** God favored Jacob over Esau from before they were born.
 God’s relationship with Jacob and Esau was set up so that a certain course in the providence of restoration could take place.

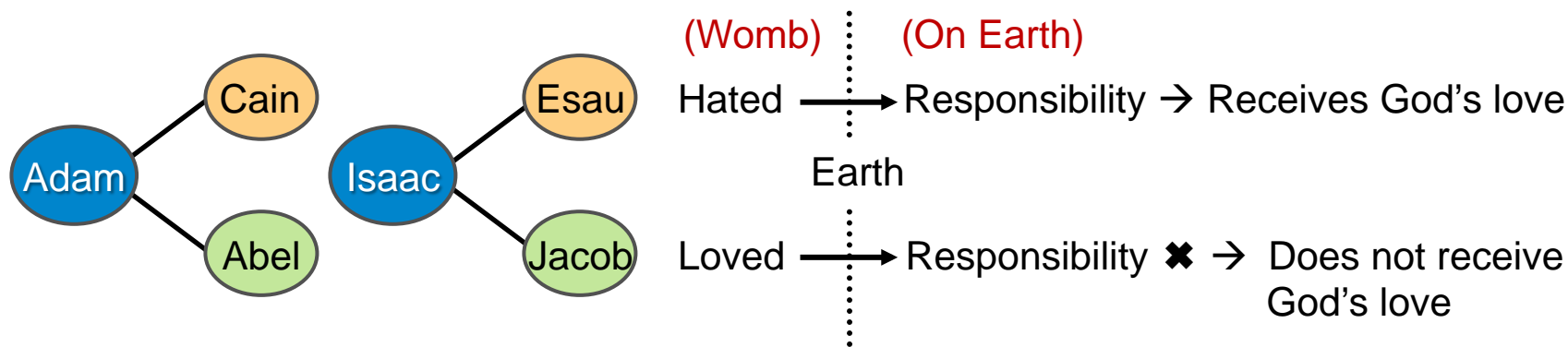

Christology

Introduction

For fallen human beings who seek salvation, there are many problems and questions to resolve. Some of the most important of these are questions concern Christology, including questions about the relationship between Jesus Christ, the Holy Spirit and God, the relationship between Jesus Christ, the Holy Spirit and fallen people, and questions about rebirth and the Holy Trinity, etc.

Up until this time, no one has been able to obtain clear and definitive answers to these questions, with the result that the unresolved issues have caused a lot of confusion in both Christian doctrine and in the practice of Christian faith.

Is Jesus God Himself?
What is Rebirth?
What is the Trinity?

1. The Value of a Person Who has Realized the Purpose of Creation

1) The 'Dual Characteristics'-type Relationship between God and a Perfect, Complete Person

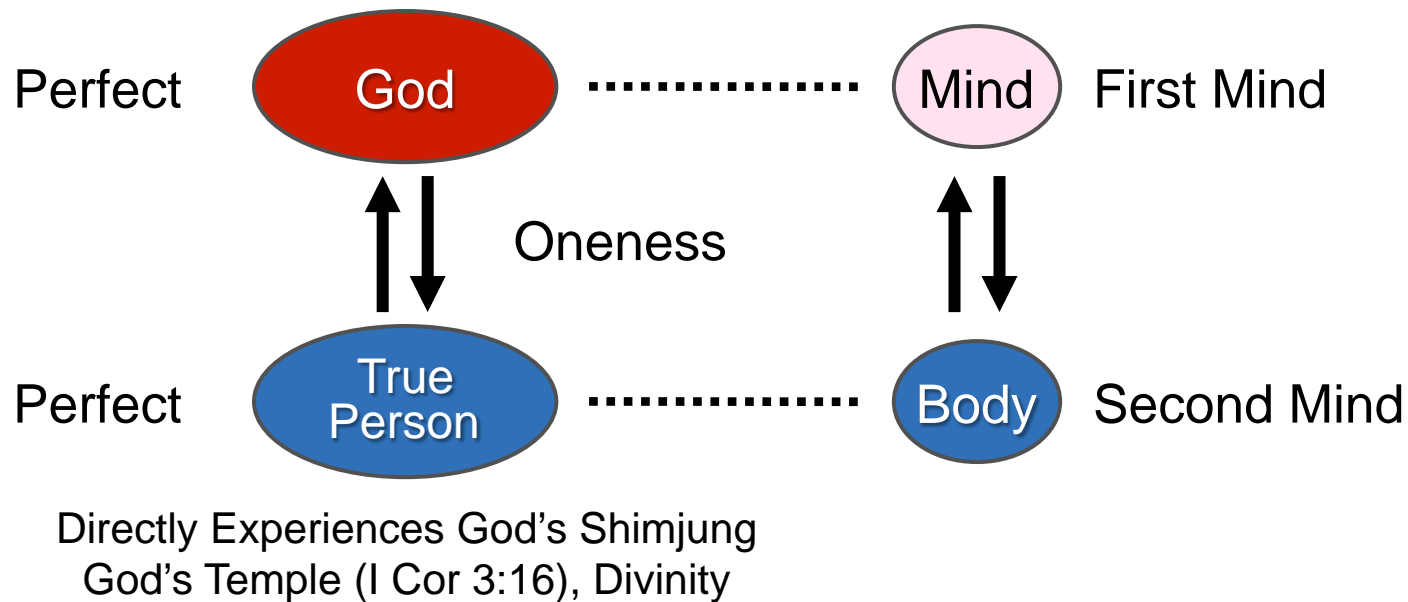

Perfect Person: Divine Value
Eternal Value

2) Consideration of the Purpose for which God created Human Beings

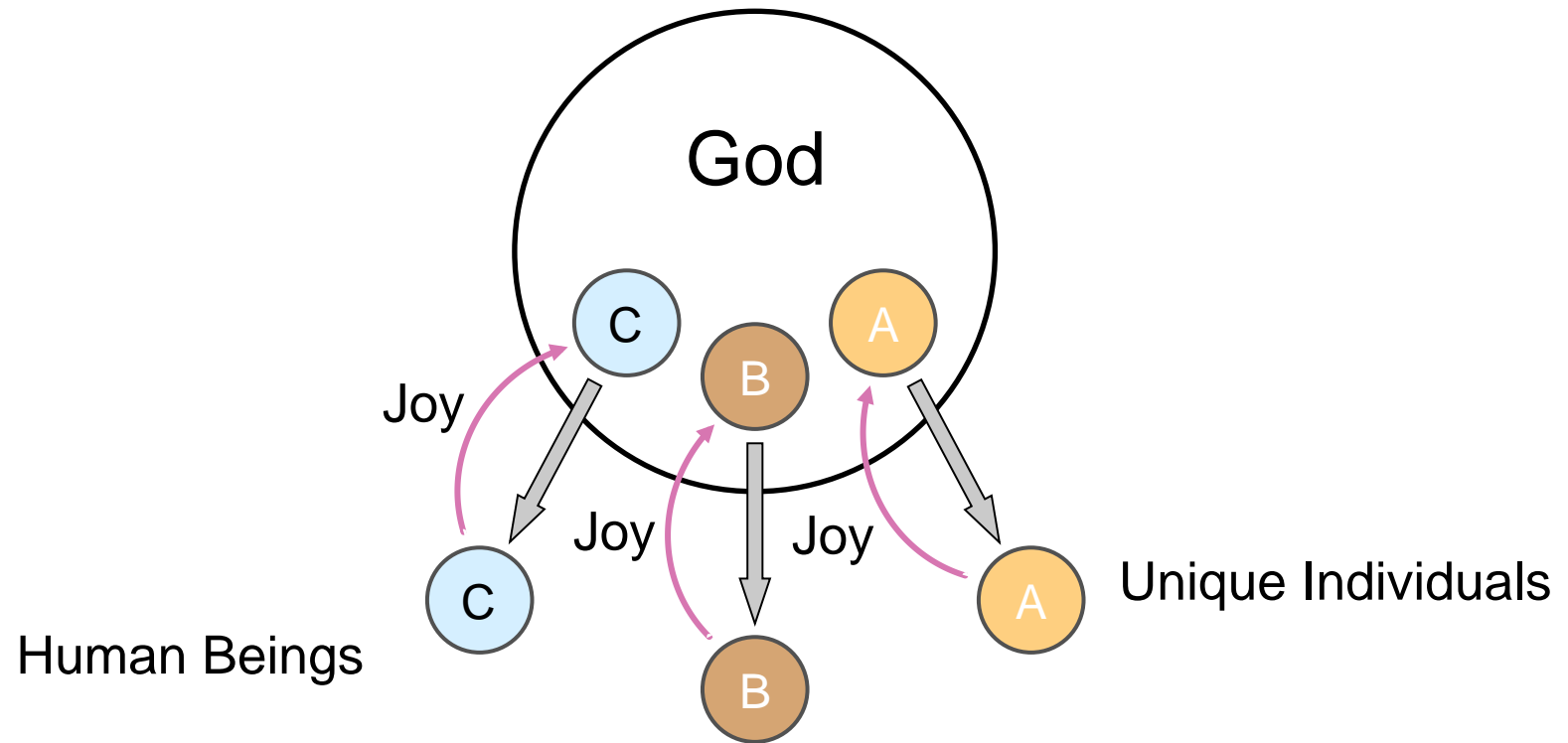

Perfect Person = Unique, Irreplaceable Value

3) Relationship between Human Beings and the World of Creation

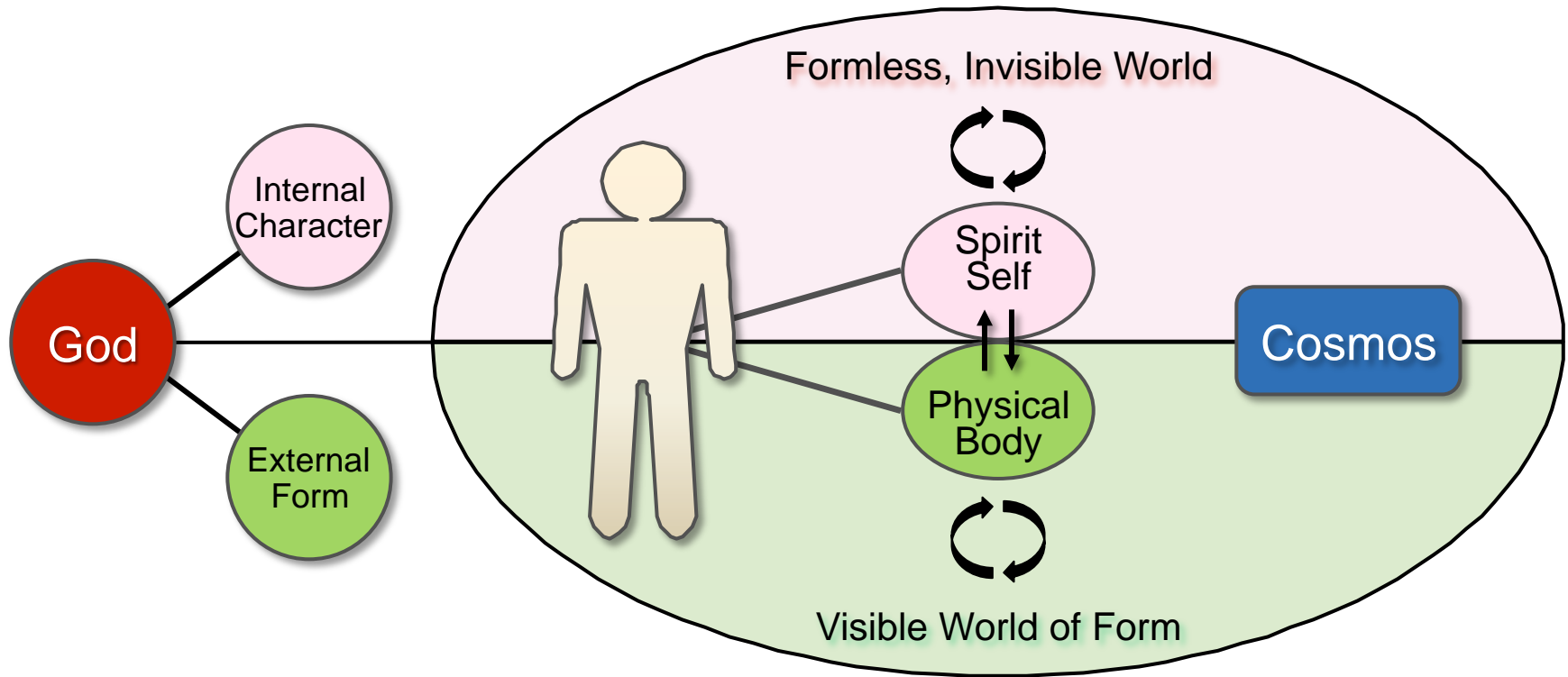

Perfected Person = Cosmic Value

2. Jesus Christ and the Human Who has Realized the Purpose of Creation

Value of a Perfected Man

=

Value of Jesus Christ

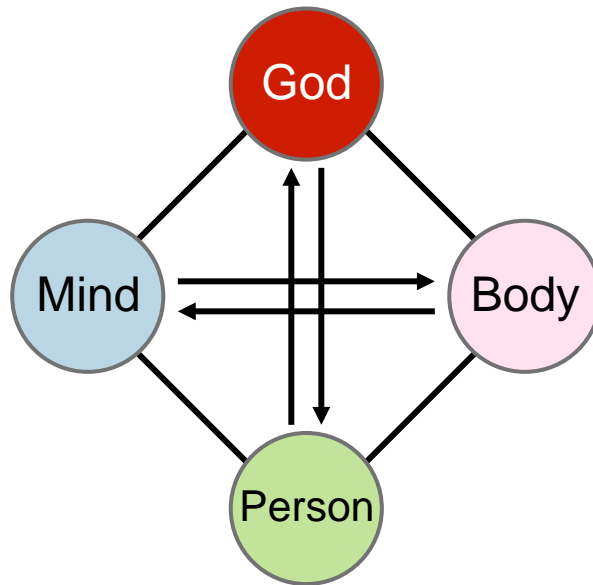

- i. Divine Value
- ii. Eternal Value
- iii. Unique Value
- iv. Cosmic Value

=

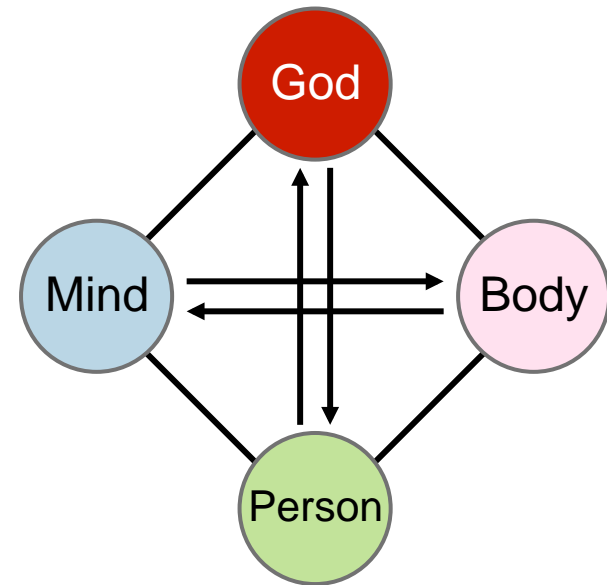

- i. Divine Value
- ii. Eternal Value
- iii. Unique Value
- iv. Cosmic Value

Jesus Christ = Human Being (Human Being who has Completed the Purpose of Creation)

1) Perfected Adam and Jesus Christ from the perspective of Restoring the Tree of Life

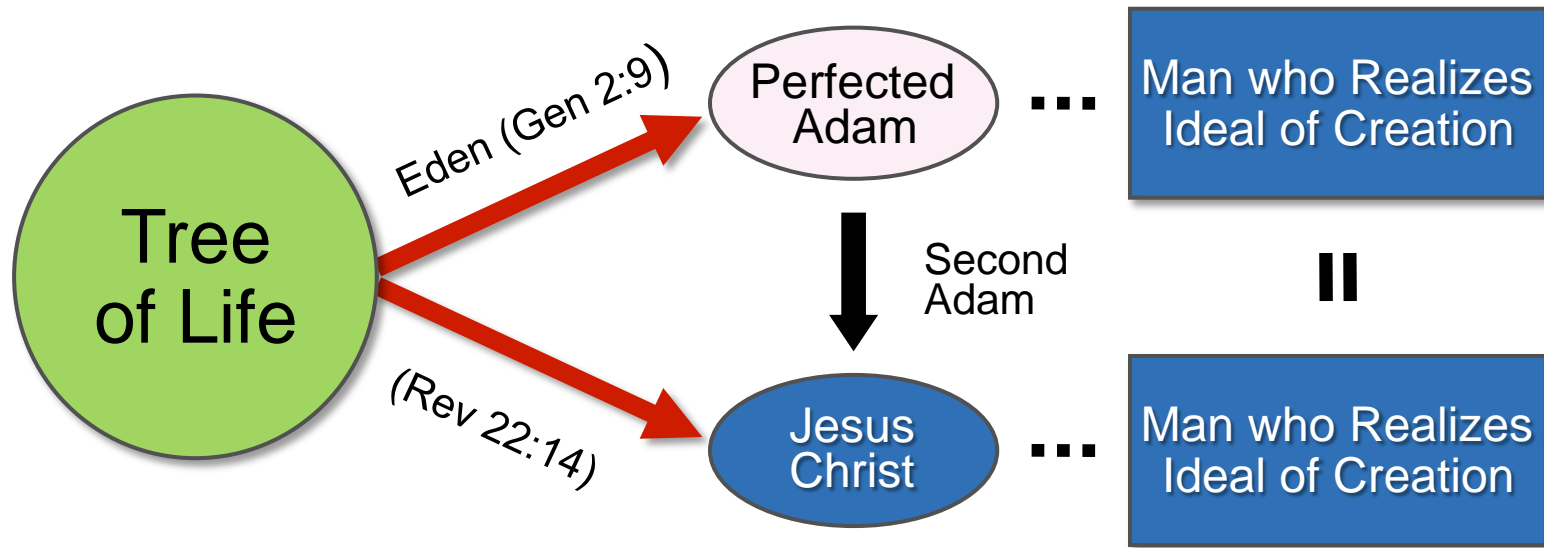

Jesus Christ = Human Being (Human Being who has Completed the Purpose of Creation)

2) Is Jesus Christ God Himself?

(1) John 14:9-10 “He who has seen me has seen the Father...”

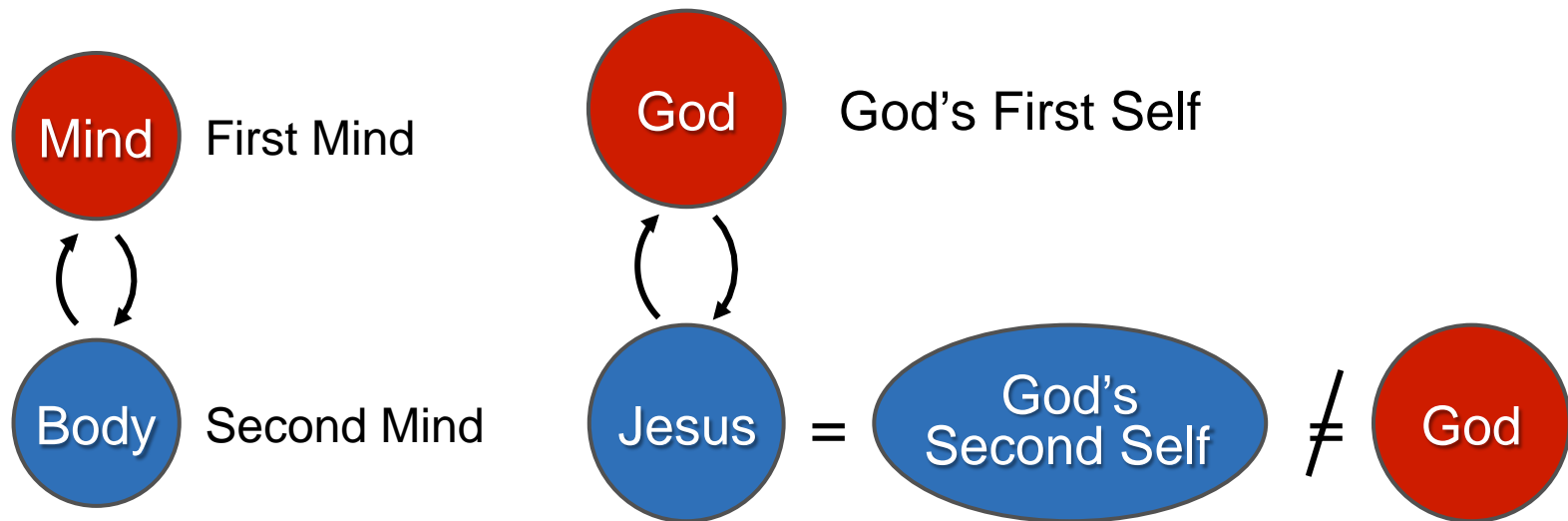

The Body is not the Mind itself

- i. Rom 8:34 Christ Jesus is at the right hand of God...
- ii. Matt 27:46 “Eloi, Eloi, lama sabachthani?”
- iii. John 17:1 After Jesus said this, he looked toward heaven and prayed
- iv. Jesus was tempted by Satan and died on the cross

Jesus Christ = Not God Himself

2) John 1:10 “and though the world was made through him...”

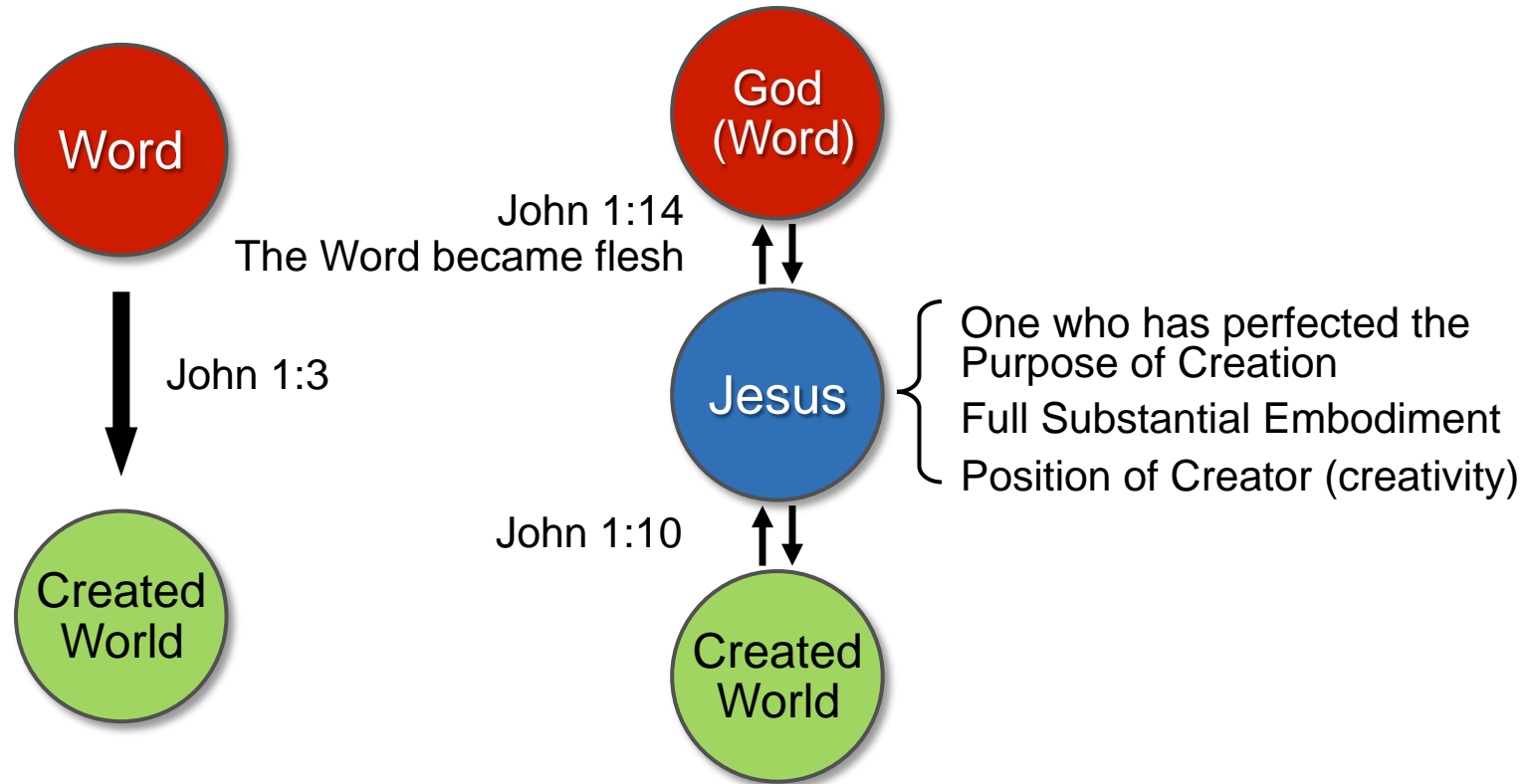

The value of God creation is realized and fulfilled through the agency of the perfected human being. From this perspective, we can truly say that the World was created through Jesus.

Jesus Christ = Not God Himself

3) John 8:58 “Before Abraham was born, I am...”

From the viewpoint of Lineage

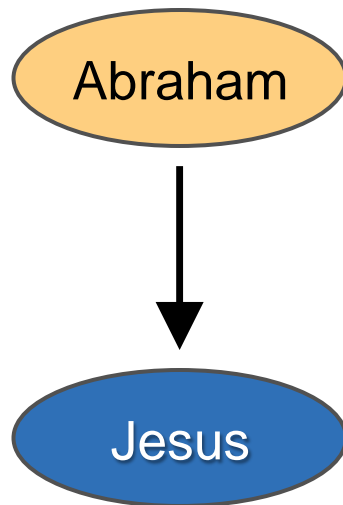

Descendent

From the viewpoint of the Providence of Restoration

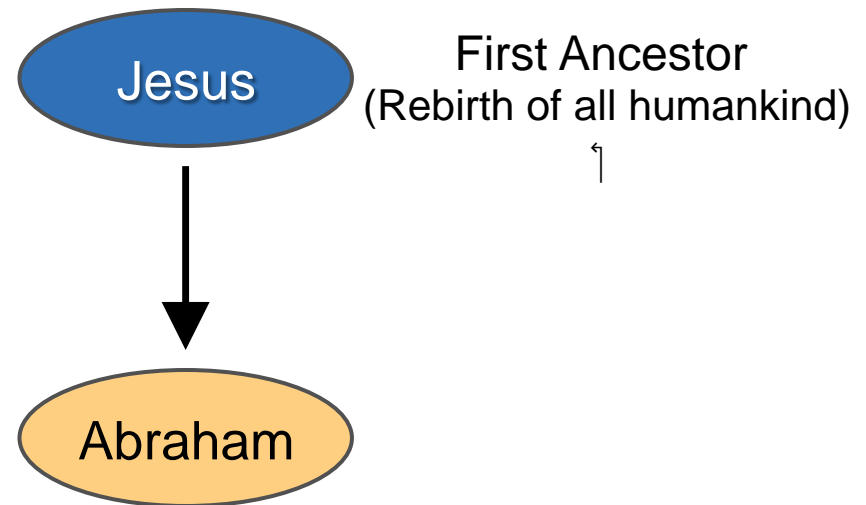

Jesus Christ = Not God Himself

3. Jesus Christ and Fallen Human Beings

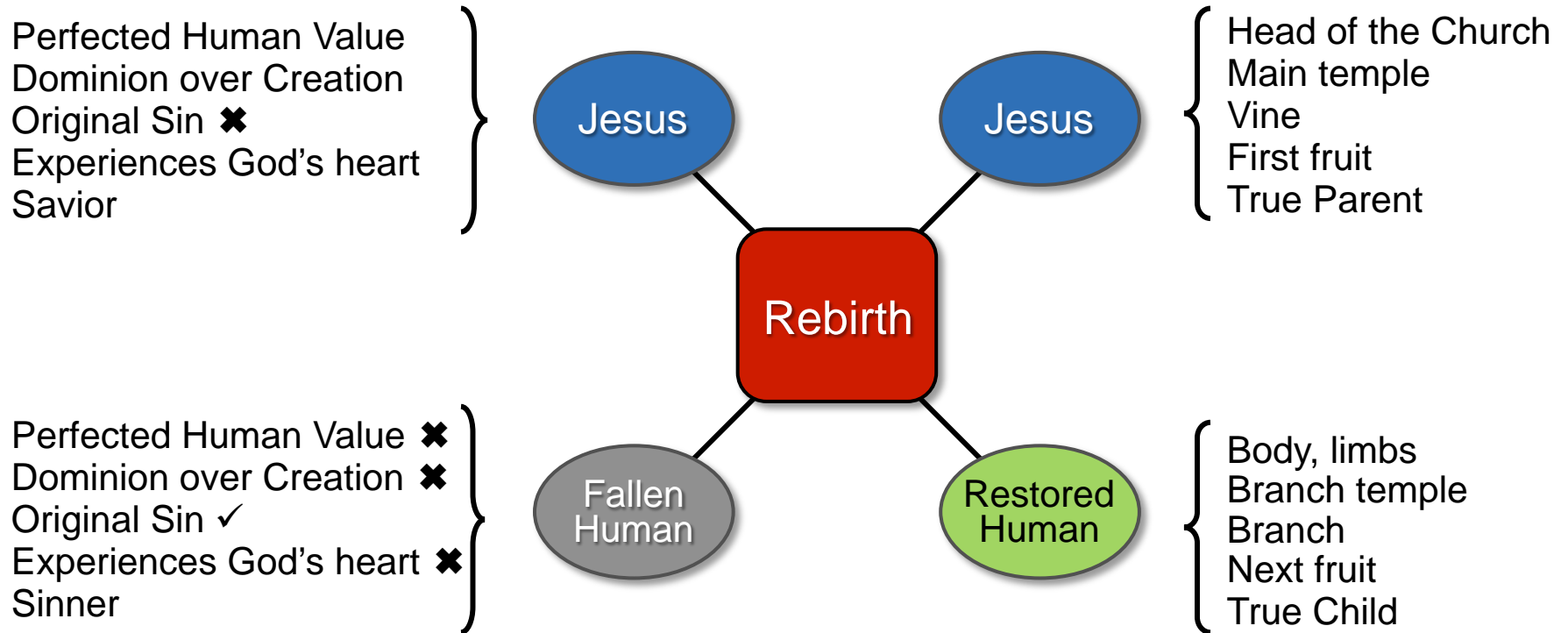

4. The Concepts of Rebirth and Trinity

1) The Concept of Rebirth

(1) Jesus Christ and the Holy Spirit and Their Mission to Give Rebirth

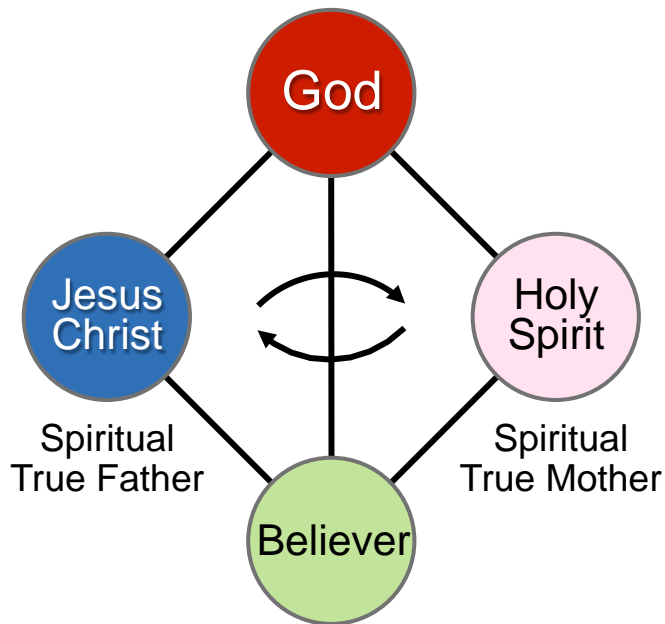

Ecc 7:28 One upright man, One upright woman

- i. God's Mother nature, 2nd Eve (Female God)[†]
- ii. Comforts and moves the hearts of believers
- iii. Works to cleanse believer's sin
- iv. Works in the earthly realm

(2) Jesus and the Holy Spirit from the Perspective of the Dual Characteristics of God

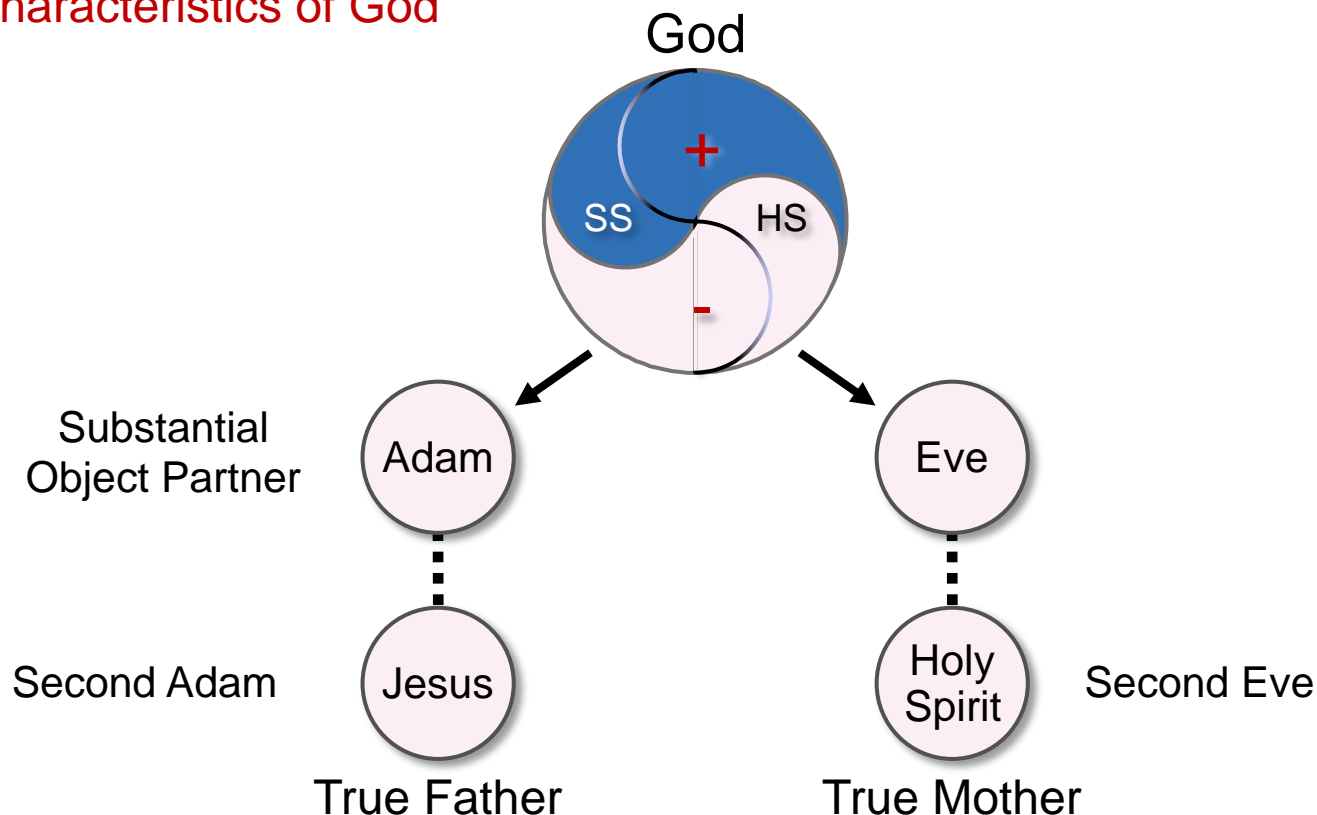

Jesus Christ came as the Second Adam and the True Father of humankind to be united in substance with the True Mother of humankind as the Second Eve. However, Jesus was unable to be married with a Second Eve in the flesh on Earth and died on the Cross. As a result, Jesus stands in the position of the Spiritual True Father to be united with the Holy Spirit as the Spiritual True Mother, and works on earth through the Holy Spirit. For this reason, we say the Holy Spirit is our Spiritual True Mother.

(3) Spiritual Rebirth through Jesus and the Holy Spirit

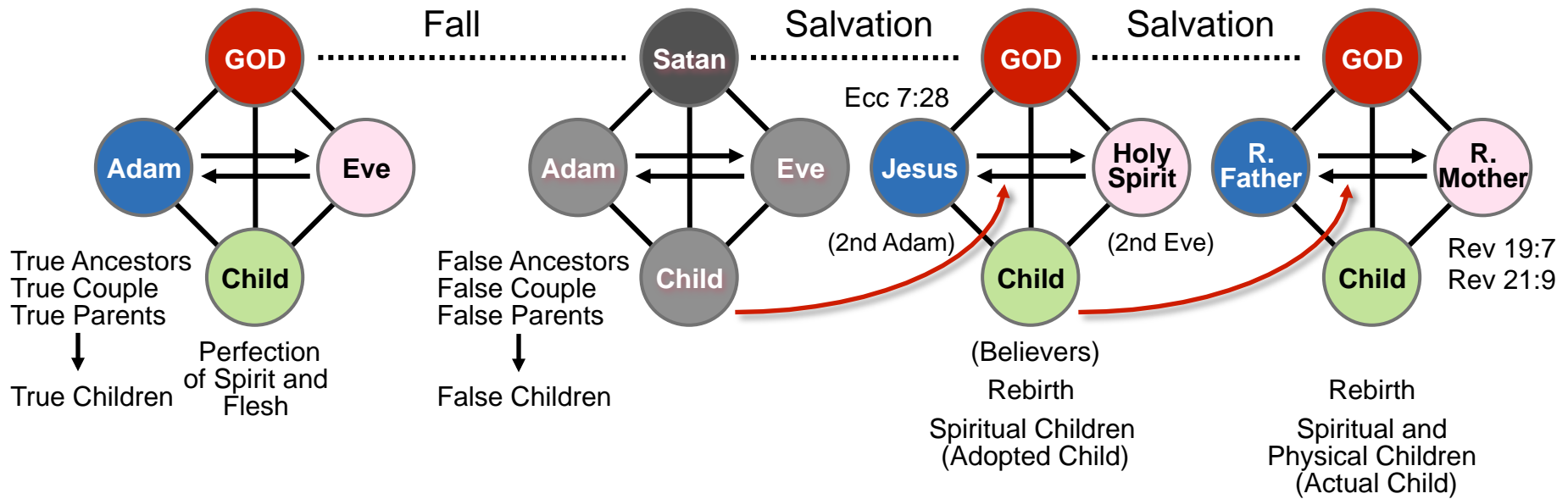

Ecc 7:28 "While I was still searching but not finding – I found one upright man among a thousand, but not one upright woman among them all."

Rev 19:7 "For the wedding of the Lamb has come, and his bride has made herself ready."

Rev 21:9 "Come, I will show you the bride, the wife of the Lamb."

(4) Liquidation of Original Sin and Actual Rebirth of Spirit and Flesh through the Blessing of the True Parents

Christ at the Second Coming comes as the True Parent, and together with the Holy Spirit made substance, will carry out the Marriage of the Lamb. When this happens, then for the first time in history, God's ideal of True Parents will be manifested, in substance, in the flesh.

When Adam and Eve fell in the Garden of Eden, they failed to become true parents and instead gave birth as false parents to a world of sexual corruption and immorality, in both spirit and flesh, centering on Satan. When Christ the True Parent comes, he will complete, conclude and finalize the providence for restoring the fallen world that the false parents created, and through his victory as the substantial True Parent, he will perfectly manifest and embody the invisible, formless True Father through True Parents.

In this way, having been spiritually reborn through Jesus Christ and the Holy Spirit, humankind will have their original sin removed through the Blessing of the victorious and substantial True Parents. Humanity will inherit the Lineage of God, be reborn in both spirit *and* in flesh, and then proceed to grow towards completion of God's Ideal of Creation by living in direct attendance to the True Parents, finally to be completely restored as human beings perfecting the original nature that God endowed them with at the Creation.

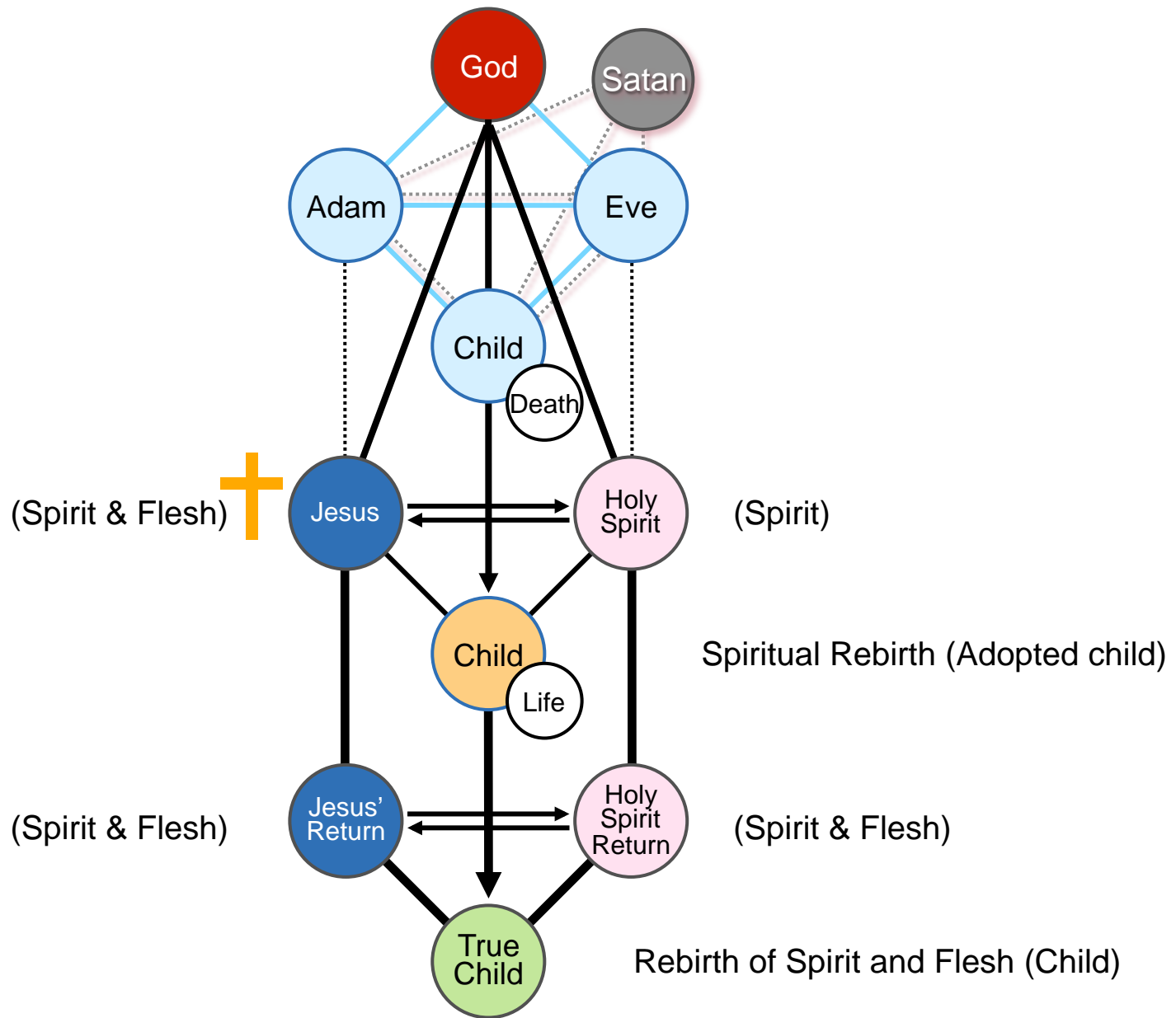

2) Concept of The Trinity

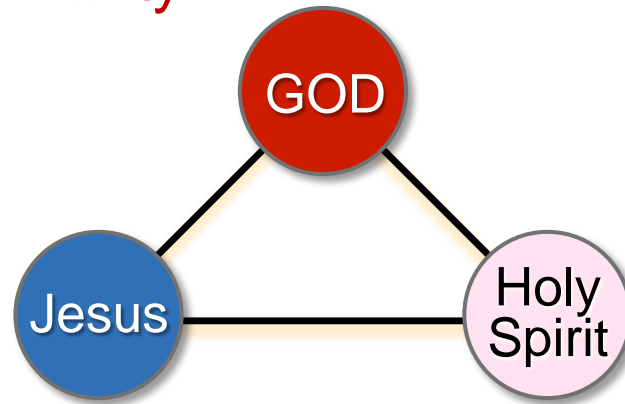

In order to accomplish God's Purpose of Creation, Jesus and the Holy Spirit must form a four-position foundation centering on God.

In this process, Jesus and the Holy Spirit become one in unity centering on God, and this oneness is what we call the Trinity.

Original Trinity

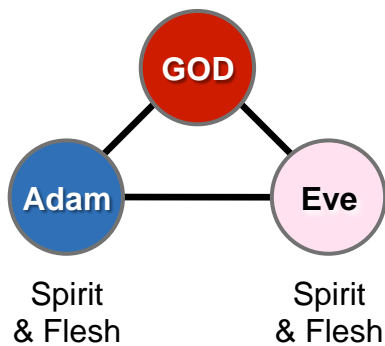

Fallen Trinity

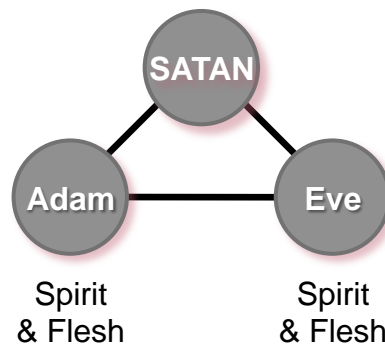

Restored Trinity
(In Spirit)

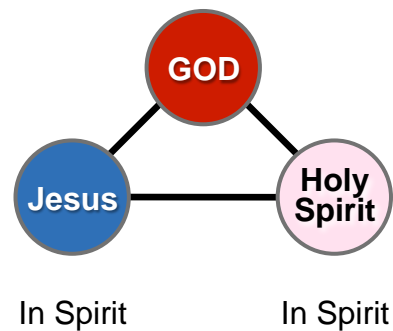

Restored Trinity
(In Spirit and Flesh)

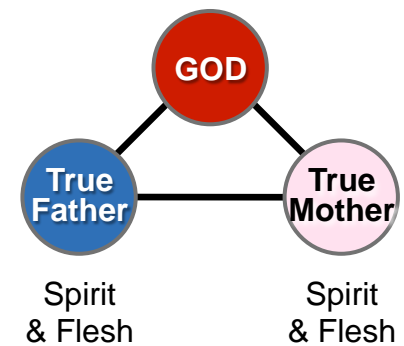

The Trinity from the Viewpoint of The Will

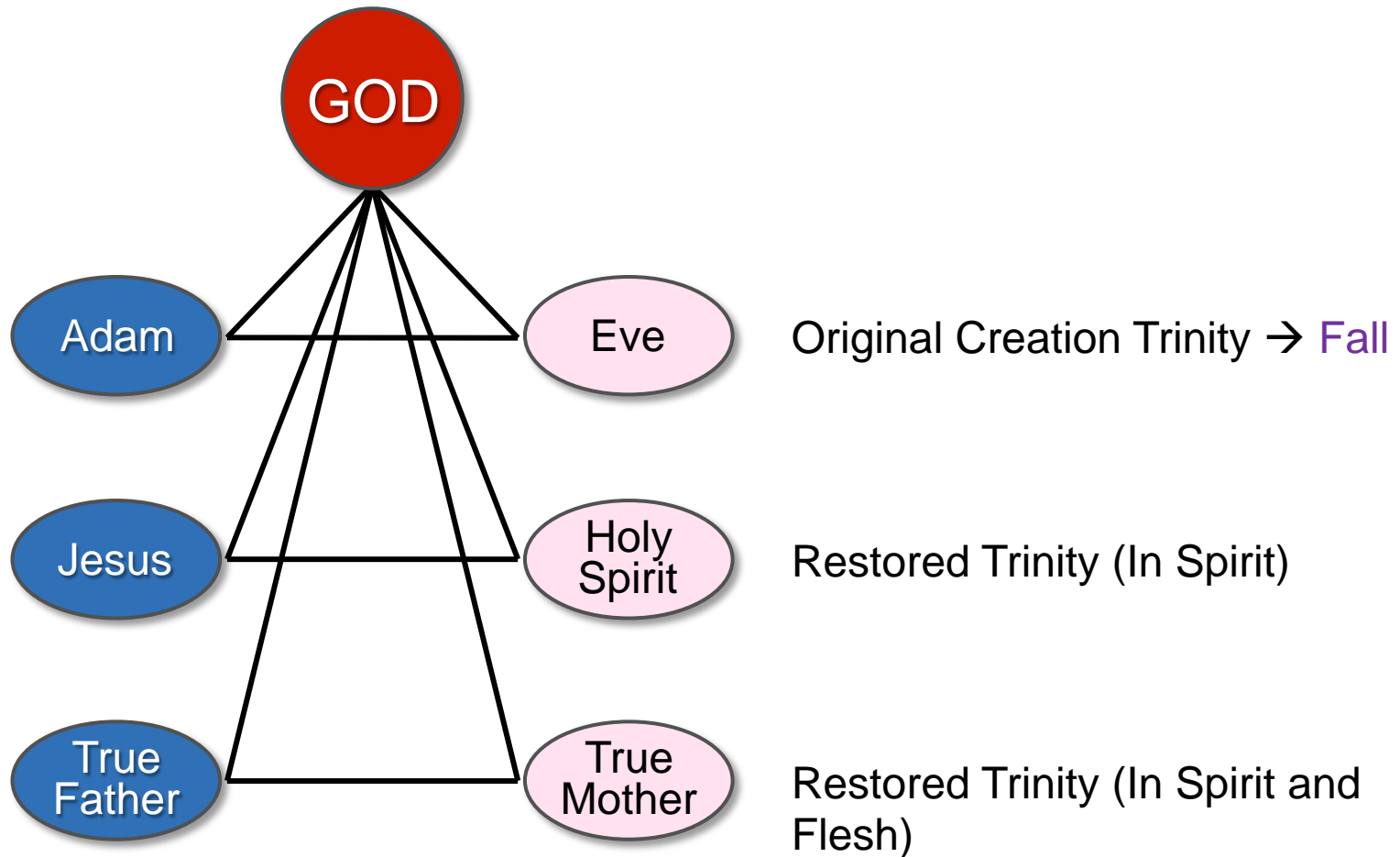

- End -

The Principle of Restoration

Introduction

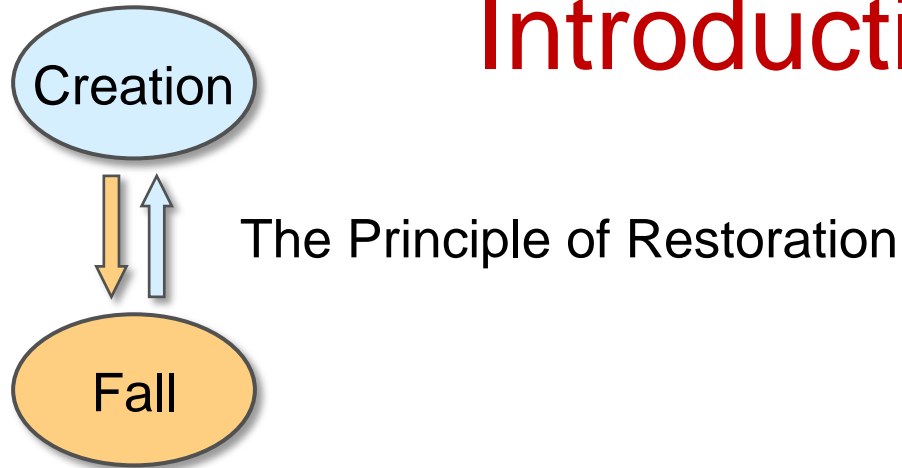

Human history is the history of God's providence of restoration.

Because the providence of restoration is the providence of re-creation that God pursues in order to recover the purpose of His creation, God conducts this providence according to His Principle. Thus, the Principle for this providence is called the Principle of Restoration.

The Principle of Restoration explains the providence of God through which fallen human beings are restored to their original created state.

Accordingly, unless fallen human beings know the contents of the Principle of Restoration they will ultimately be unable to find the path to Life.

This is the reason why we must clearly know and understand the Principle of Restoration.

I. The Providence of Restoration and the Messiah

1. The Providence of Restoration

1) The Position of Human Beings as They Were Originally Created and the Position of Fallen Human Beings

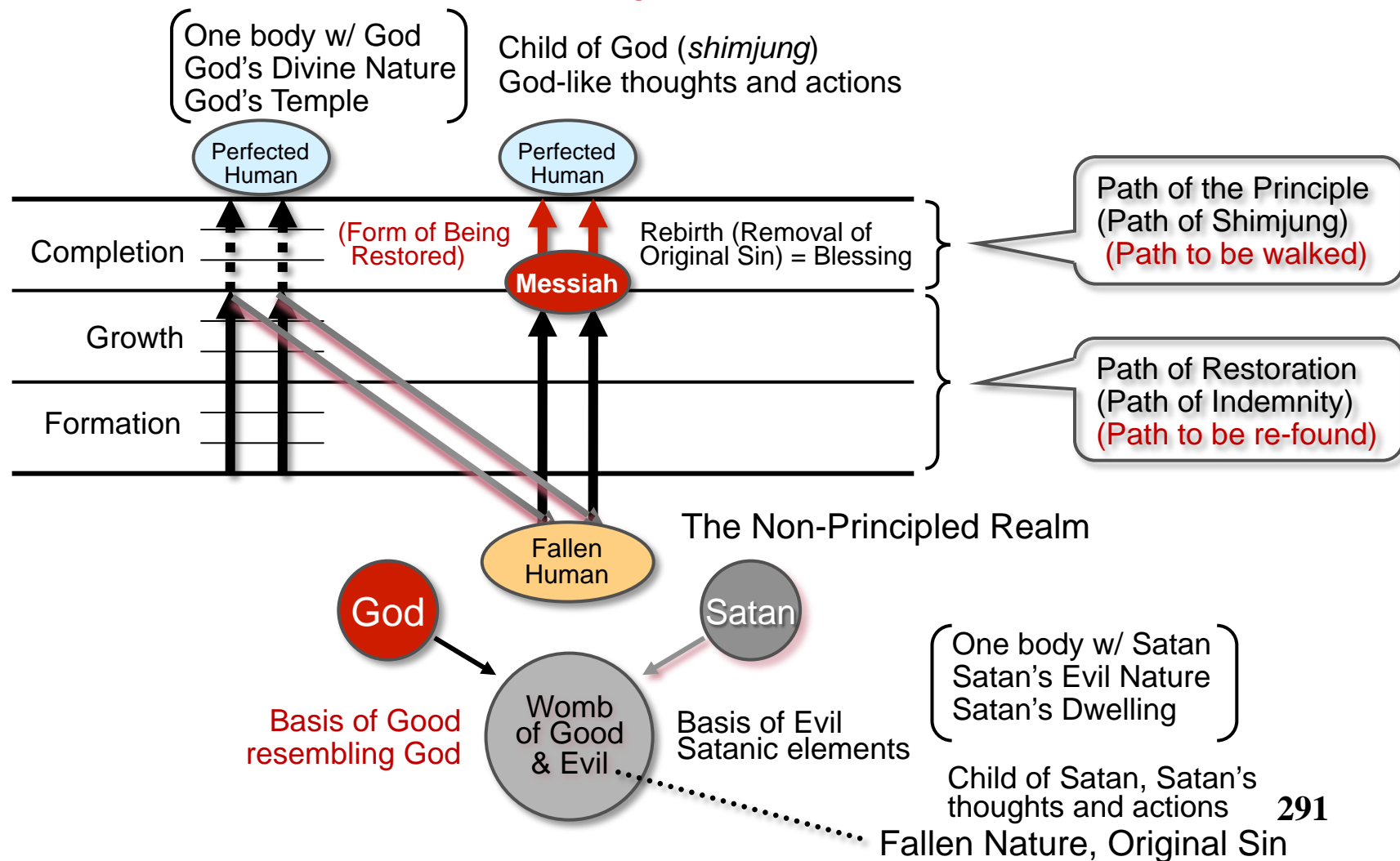

2) The Womb (Origin) of Good and Evil

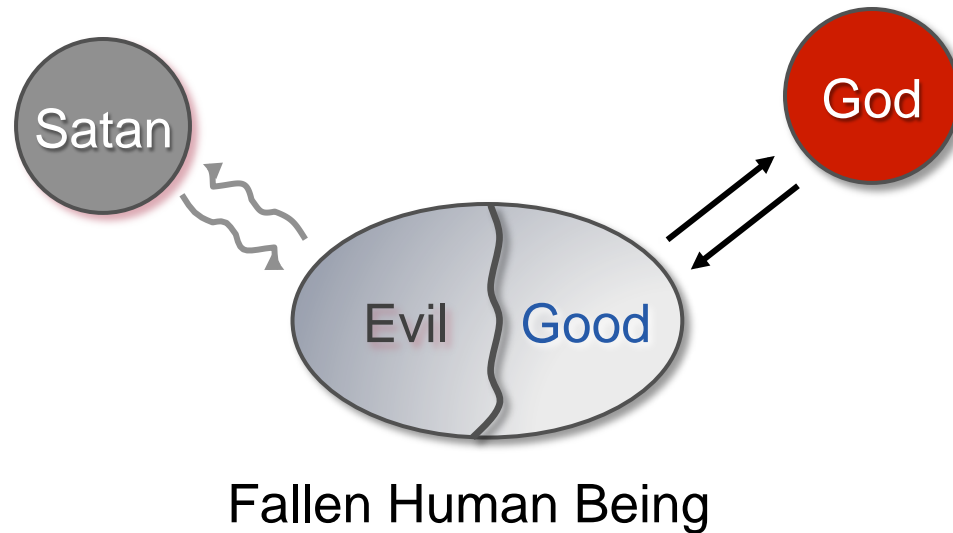

Good and evil do not act or function to the same degree within human beings.

In the case of a fallen human being, **the basis of evil is a completed, decisive element**, and for this reason, it is easily triggered into action and easily expressed.

On the other hand, in fallen human beings, **the basis of good is as yet imperfect, and without a conscious effort** to encourage and develop it, it cannot easily bear fruit.

3) The Restoration of Fallen Human Beings

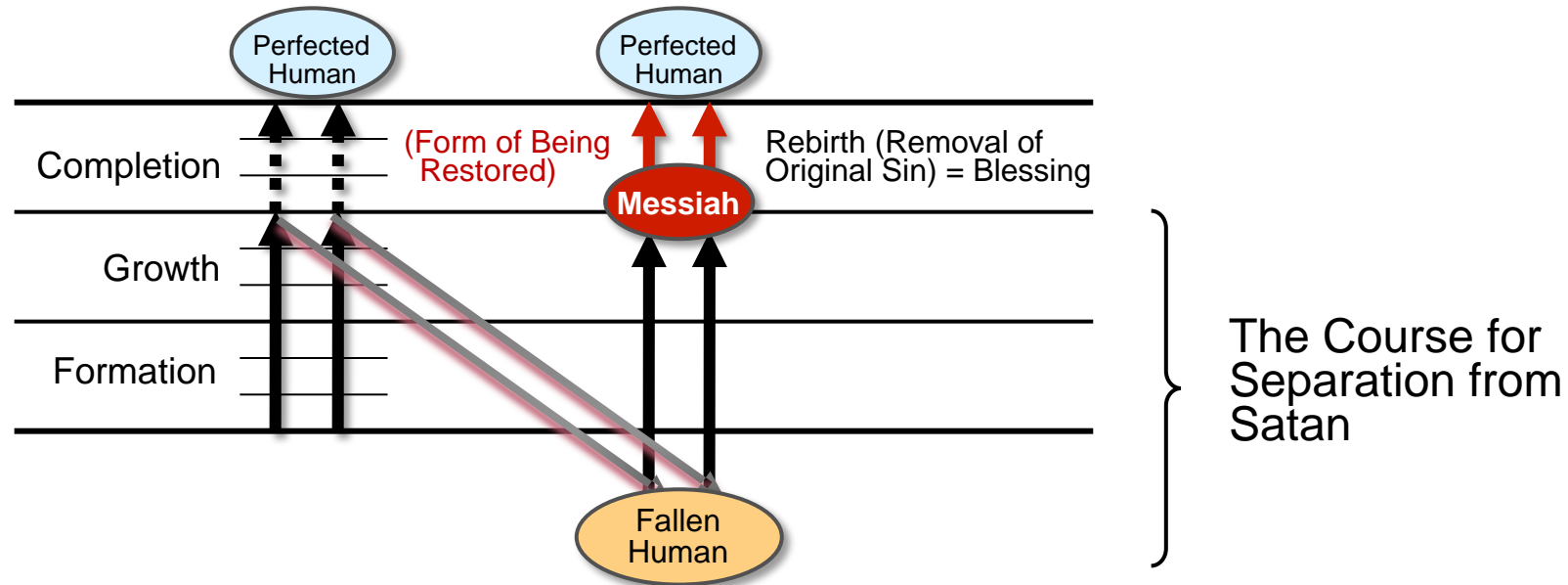

- (1) Firstly, human beings have their fallen nature removed through a course of separation from Satan.
- (2) Next, they restore the form or image of having been restored up to the top of the completion level of the growth stage.
- (3) On this foundation, human beings must meet the Messiah and be reborn through him (that is, have their original sin removed by him), thus restoring the position of human beings prior to the Fall.
- (4) Finally, by following and attending to the Messiah (the True Parent), human beings must complete their growth (to achieve perfection of *shimjung*) and become a perfectly completed substantial self.

(5) Completion salvation is achieved and accomplished through the agency of the True Parent.

True Parent

- i. At what point does the Messiah come? At the completion level of the growth stage. Reason: Adam and Eve fell at the completion level of the growth stage of the growing period.
- ii. Why must fallen human beings receive the Blessing? In order to have their original sin liquidated and removed.
- iii. Why do fallen human beings receive the Blessing at the completion level of the growth stage?

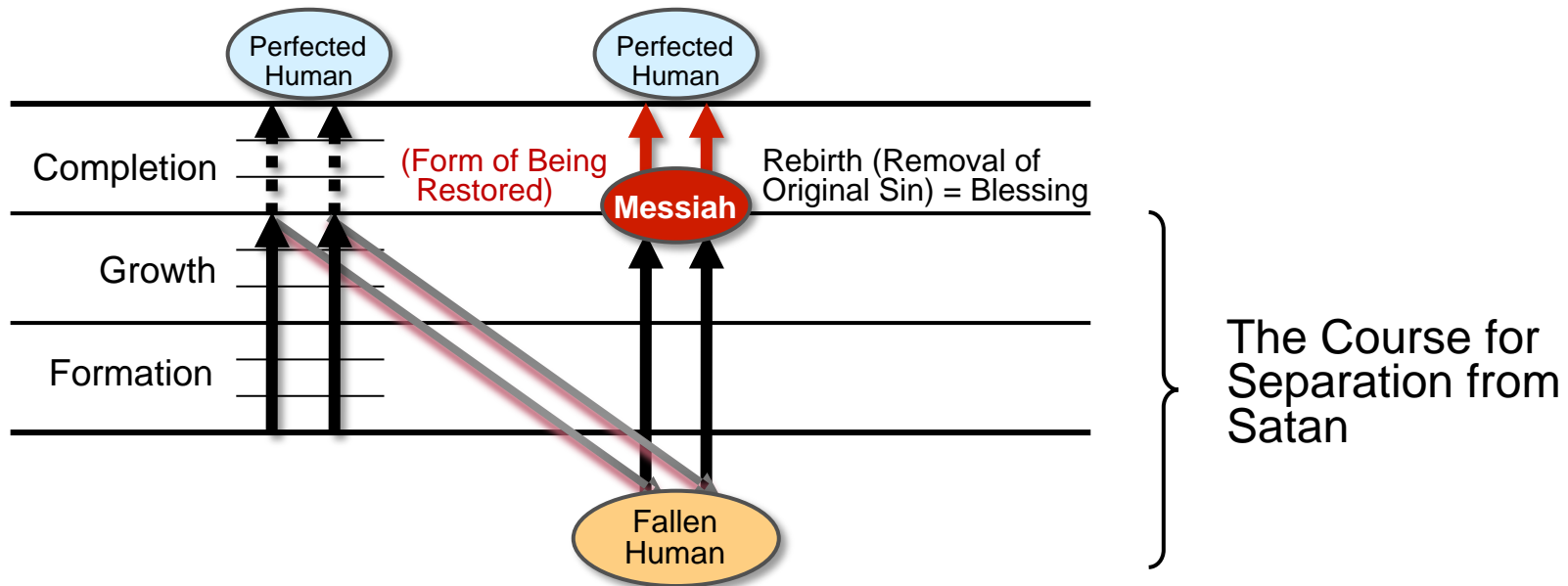

4) The Multi-Dimensional History of the Conflict between Good and Evil

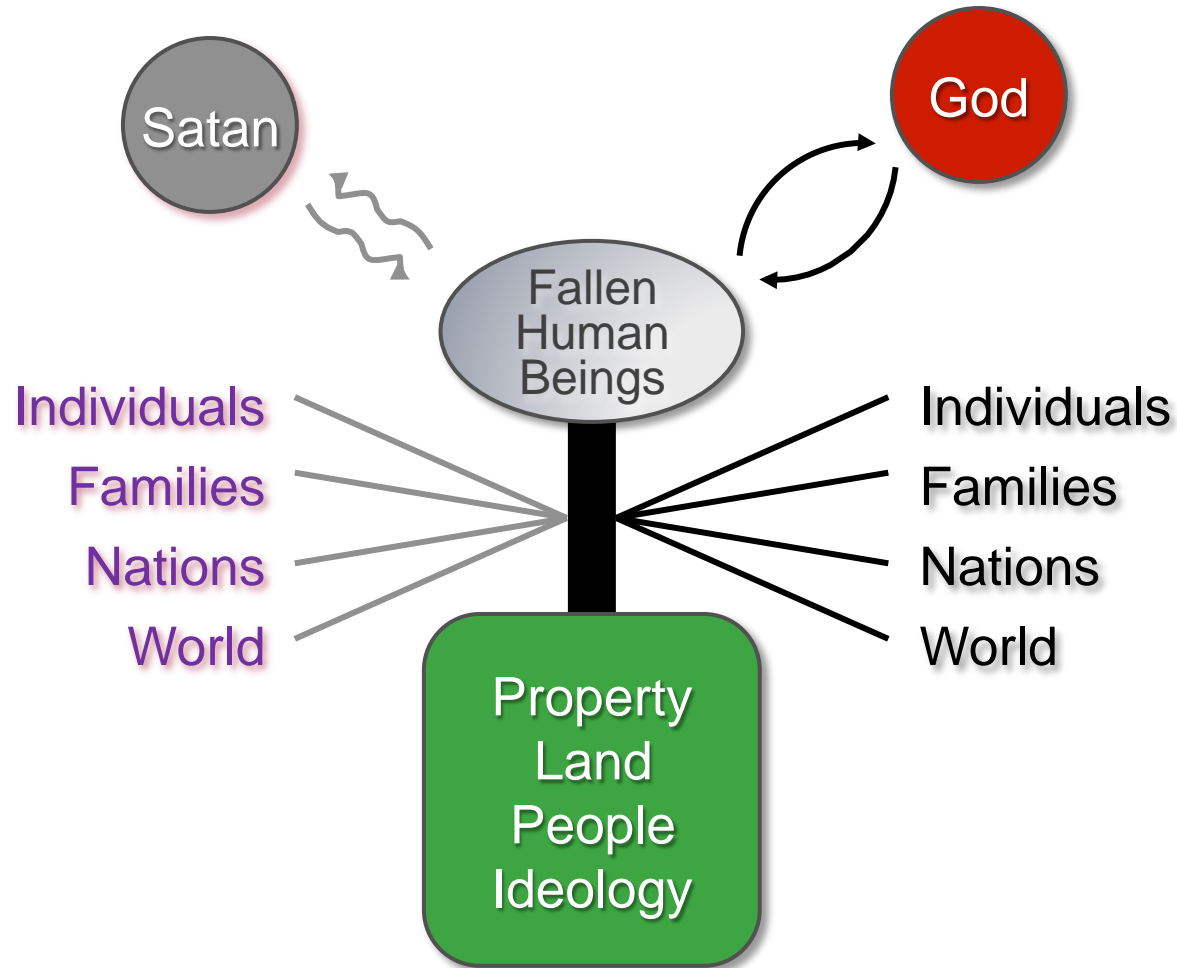

5) The Dominant Factor in the Development of History

100%
Completion of
God's Will

||

95% God's
Responsibility

+

5% Human
Responsibility

{ Completed → God's Will manifested in history
Failure → Satan's will manifested in history

2. The Providence of Restoration through Indemnity

1) Fallen Human Beings are in the Midway Position

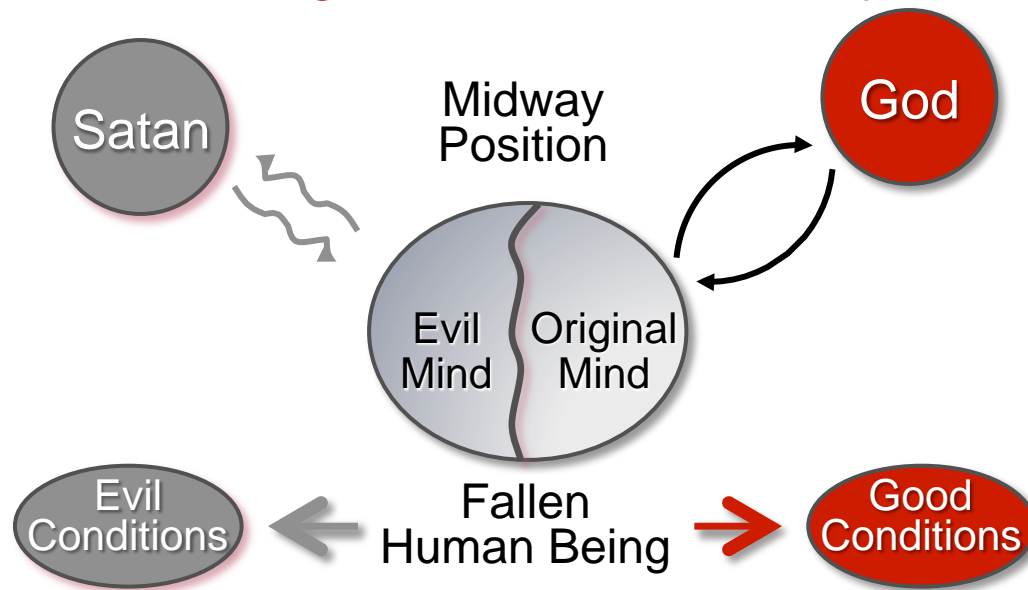

(1) Definition of Indemnity: When a person loses his or her original position or state of being, indemnity refers to the establishment of conditions that a person must make in order to be restored back to that lost original position.

- i. Restoration thru Indemnity: Process whereby fallen human beings return to their original position by establishing conditions
- ii. Indemnity Condition: A condition that is established in order to restore a person or thing through indemnity
- iii. Providence of Restoration thru Indemnity: God's providence to restore human beings to the state they were in when originally created by having them establish indemnity conditions

(2) Types of Indemnity Conditions

- i. Indemnity Condition of Equal Value
(Exodus 21:23-25 - Life, Eye, Tooth, Hand, Foot)
- ii. Indemnity Condition of Lesser Value
(Faith, Baptism, Holy Communion, Humble Apology)
- iii. Indemnity Condition of a Greater Value
(Sacrifice of Isaac, 40 years in the Wilderness)

3) Method by which Indemnity Conditions are Established

i. The Reverse (Opposite) Course

- Adam → Betrayed God ↔ God → Abandoned Jesus (Matt 27:46)[†]
- Israel → Hated **Jesus** **+** ↔ Israel → Must love **Jesus** and take up **+**
- Adam → Betrayed the Will → Caused **God** Grief ↔ Humankind → Love the Will → Comfort **God**
- Adam forsook **God**, fell → Humankind fell into **Satan**'s bosom ↔ In order to recover humankind from the bosom of **Satan** and return them to **God**, **Jesus** had to worship and honor **God** despite being abandoned by **God**.

✘ Do Not Resent or Blame God. Do Not Resent or Blame Anyone.

ii. Who Establishes Indemnity Conditions?

Fallen human beings themselves are the ones who must establish indemnity conditions.

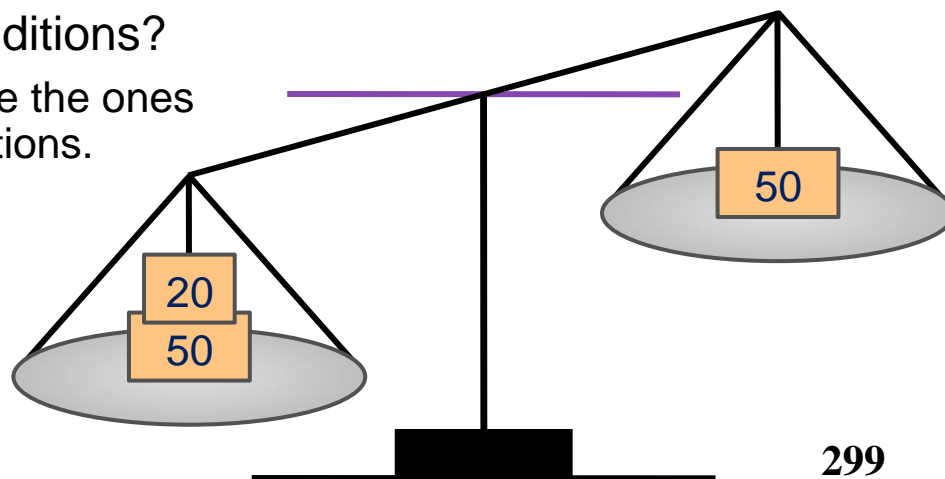

2) What Indemnity Conditions Should Fallen People Make?

We need to know what conditions Adam and Eve originally should have made. Why? Because indemnity conditions are established through the reverse course.

(1) The Conditions That Adam and Eve Should Have Established

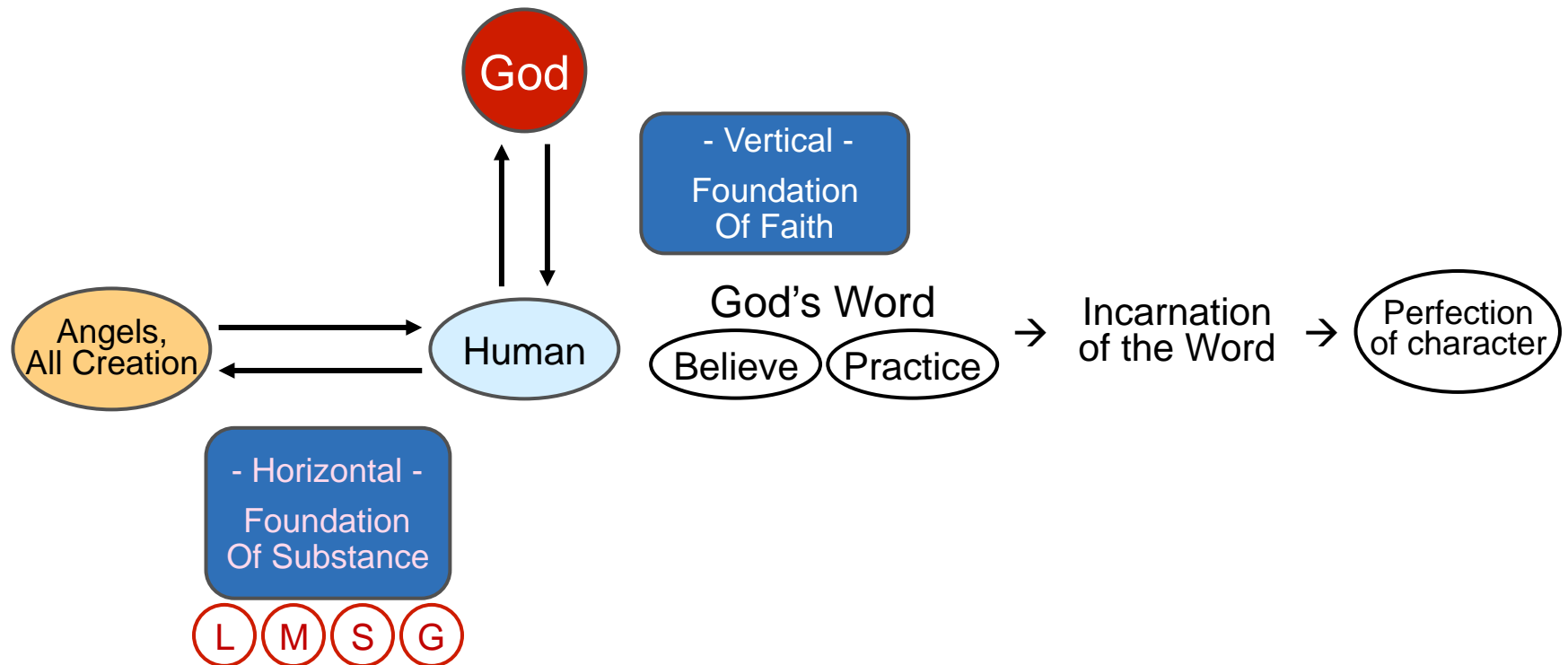

Govern over Creation and the Angels as a person of perfected character
→ Establish Order within the Created World

(2) The Indemnity Conditions for the Removal of Fallen Nature

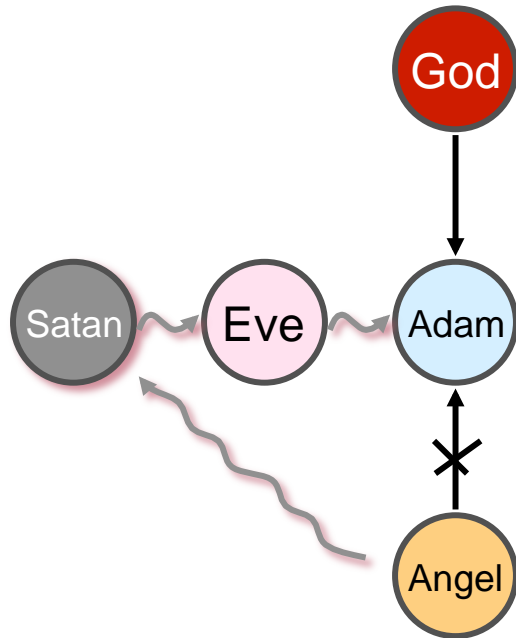

Fallen Nature	Restoration
Inability to love from God's viewpoint (jealousy, envy)	Love (L)
Leaving one's 'position for existence' (rashness and intemperance)	Mediator (M)
Reversal of governance (arrogance)	Obedience & submission (S)
Multiplication of evil (stubbornness)	Multiply God's Will of Goodness (G)

3. The Foundation for the Messiah

(The hope of history is to establish a relationship with the Messiah)

Fallen human beings must be restored to the state in which they were originally created.

For this to happen, they must establish a relationship with the Messiah.

To establish a relationship with the Messiah, human beings must first establish the Foundation for the Messiah.

If there is no Foundation for the Messiah, fallen people will kill the Messiah when he comes.

1) The Foundation of Faith

- Determines Ownership
God's perspective - Ownership
Human perspective - Faith
- Offering becomes God's,
belongs to God

- i. **Central Figure** = Father
- ii. **Object for the Condition** = Symbolic Offering
The Word, Sacrifice, ark, the tabernacle, the temple,
Torah, Gospel, Jesus, True Parent (Principle, Teaching)
- iii. **Time Period** = Growing Period (12, 4, 21, 40)

2) The Foundation of Substance

- Determines Governance
Good governs Evil
Evil Submits to Good
- Offering becomes God's, made
by God

- i. **Central Figure** = Second son
- ii. **Condition** (Substantial Offering)
Indemnity Condition to Remove the
Fallen Nature

II. The Course of the Providence of Restoration

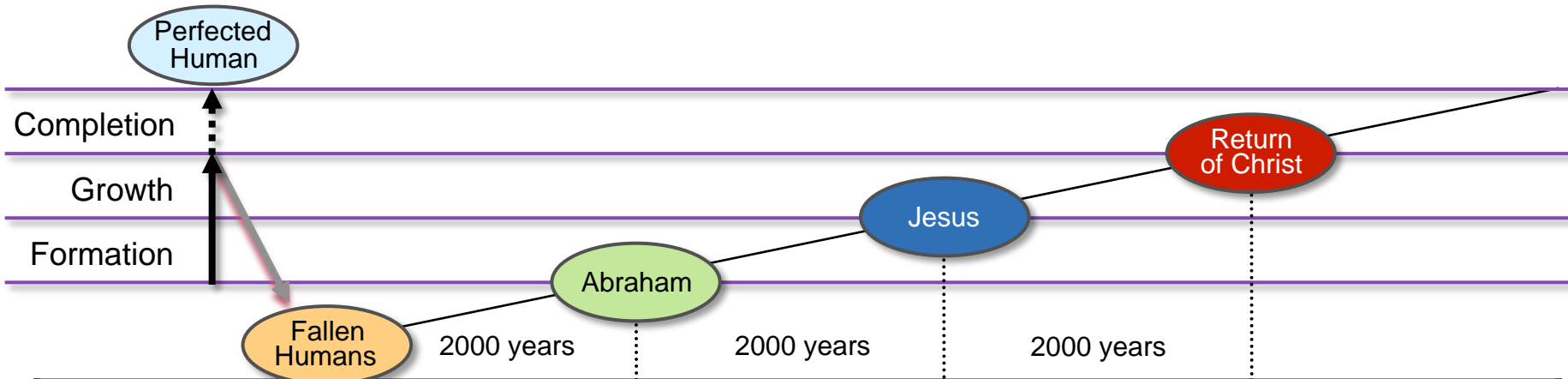

i. Providence according to the Word	Era of the Providence to lay the Foundation for the Word	Old Testament Era (Formation)	New Testament Era (Growth)	Completed Testament Era (Completion)
ii. Providence for Resurrection	Era of the Providence to lay the Foundation for Resurrection	Era of the Providence for Formation-stage Resurrection	Era of the Providence for Growth-stage Resurrection	Era of the Providence for Completion-stage Resurrection
iii. Providence to Restore thru Indemnity the Period of Faith	Era of the Providence to lay the Foundation for Restoration thru Indemnity	Era for the Providence of Restoration through Indemnity	Era for Prolongation of the Providence of Restoration through Indemnity	Era for Completion of the Providence of Restoration through Indemnity
iv. Scope of the Foundation for the Messiah	Era of the Providence for the Family-level Foundation for the Messiah	Era of the Providence for the Ethnic Group-level Foundation for the Messiah	Era of the Providence for the World-level Foundation for the Messiah	Era of the Providence for the Cosmic-level Foundation for the Messiah
v. Portion of Responsibility	Era of the Providence to Lay the Foundation for God's Portion of Responsibility	Era of the Providence based on God's Portion of Responsibility	Era of the Providence based on Jesus & the Holy Spirit's Portion of Responsibility	Era of the Providence based on Believers' Portion of Responsibility
vi. Providential Time Parallels	Era of Symbolic Providential Time Parallels	Era of Image-type Providential Time Parallels	Era of Substantial Providential Time Parallels	303

III. The History of the Providence of Restoration and Myself

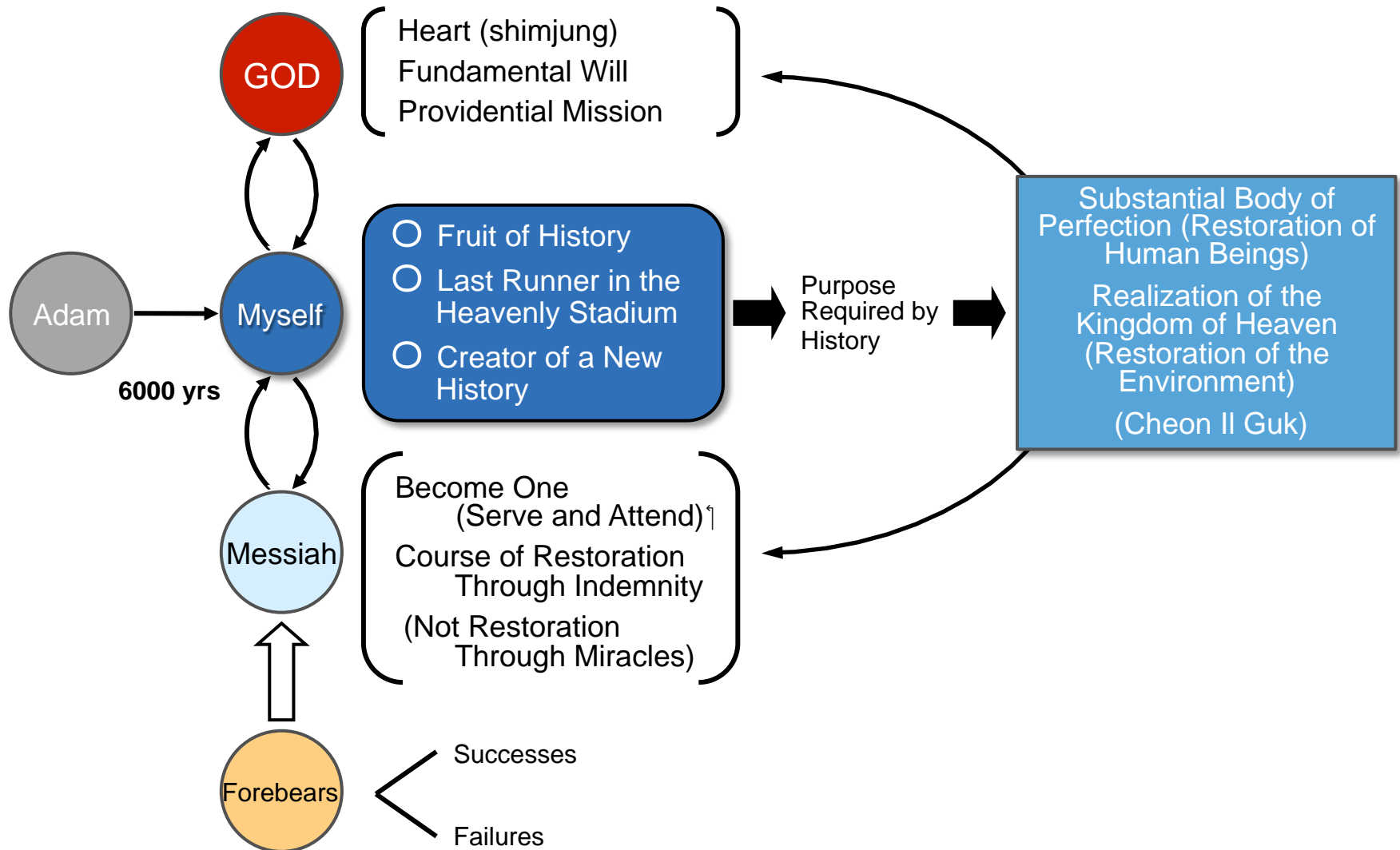

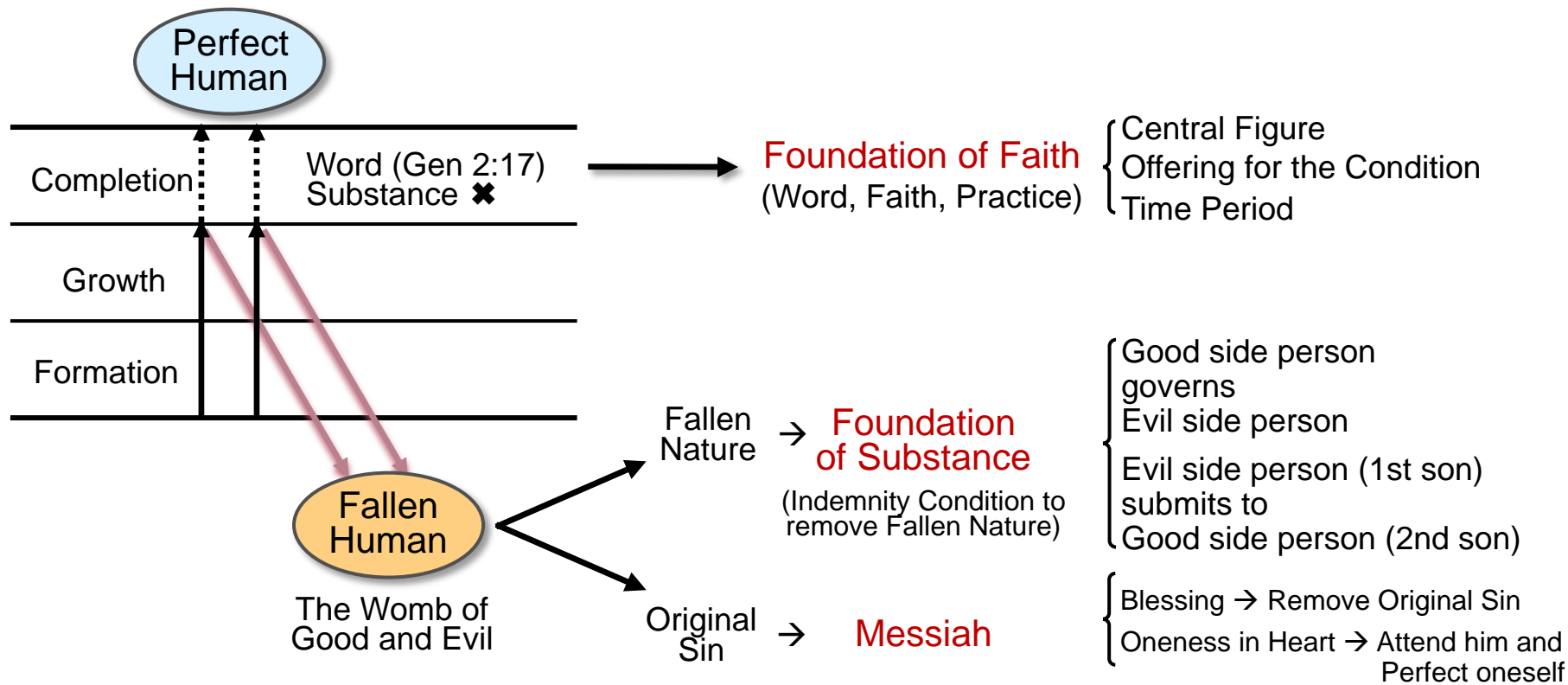

The Providence of Restoration Centering on Adam's Family

Introduction

God Will for the Providence of Restoration in which He works to send the Messiah and bring salvation to fallen humanity began straight after Adam's Fall. Thus, the Providence to lay the Foundation for the Messiah was begun straight away, in Adam's family.

Fallen human beings need to clearly understand the details of Adam's family. This is because Adam's family involves all these aspects: God's Creation, the Fall of human beings, and the Restoration providence.

I. The Foundation for the Messiah

Fallen human beings must be restored to the state in which they were originally created. For this to happen, they must establish a relationship with the Messiah.

To establish a relationship with the Messiah, human beings must first establish the Foundation for the Messiah.

If there is no Foundation for the Messiah, fallen people will kill the Messiah when he comes.

The Foundation of Faith

- i. Central Figure: ~~Adam~~ → Abel
- ii. Object for the Condition (Symbolic Offering): Lamb
- iii. Time Period: Growing Period

The Foundation of Substance (Substantial Offering)

- i. Central Figure: Abel
- ii. Condition: Indemnity Condition to Remove the Fallen Nature

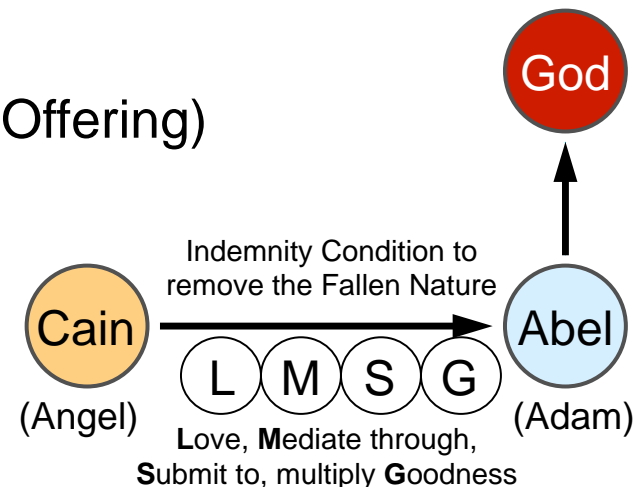

1. The Foundation of Faith

- i. Central Figure: ~~Adam~~ → Abel
- ii. Object for the Condition: Lamb
- iii. Time Period: Growing Period

1) Reasons that Adam could not become the Central Figure

- (1) Adam was the key figure who committed the Fall.
- (2) Adam was an unprincipled being (could relate to two masters).
- (3) Adam was the womb and source of Good and Evil.
- (4) Adam failed to take responsibility for his actions.

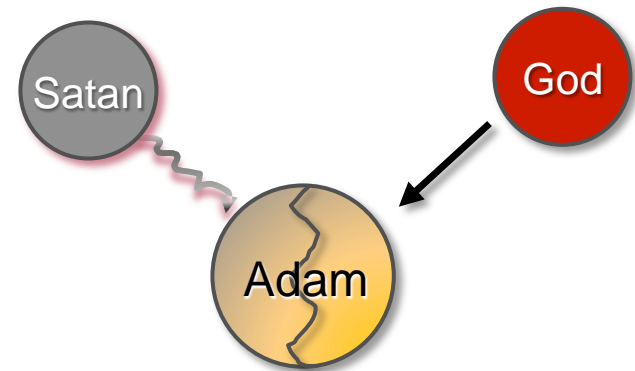

Womb/source of Good and Evil

2) God's Work of Division (Separation of Good and Evil)

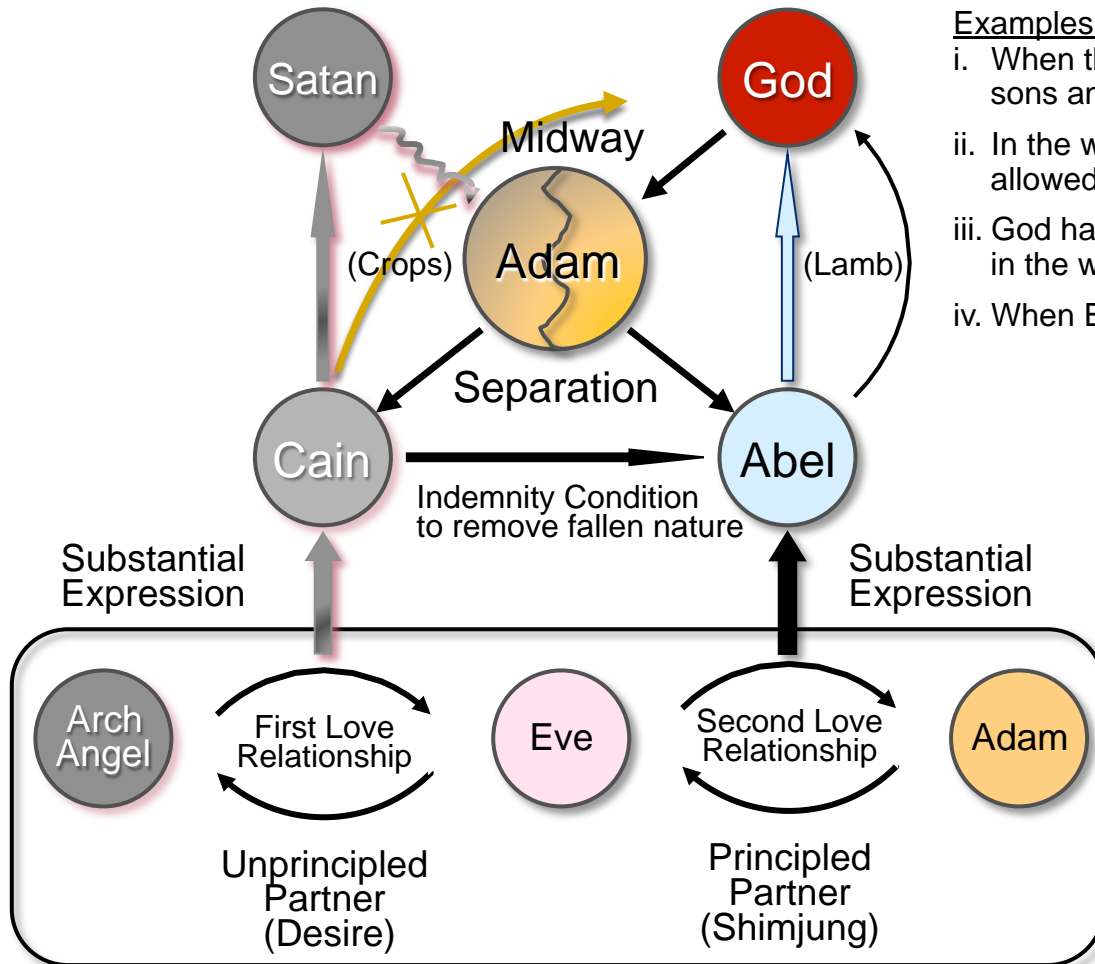

Examples

- i. When the Israelites fled Egypt, God struck the firstborn sons and firstborn of the livestock (Exod 12:29)
- ii. In the wilderness course, only the younger sons were allowed to carry the Ark of the Covenant (Num. 31:25)
- iii. God hated Esau and loved Jacob even when they were in the womb (Gen 25:23)
- iv. When Ephraim and Manasseh was blessed (Gen 48:14)

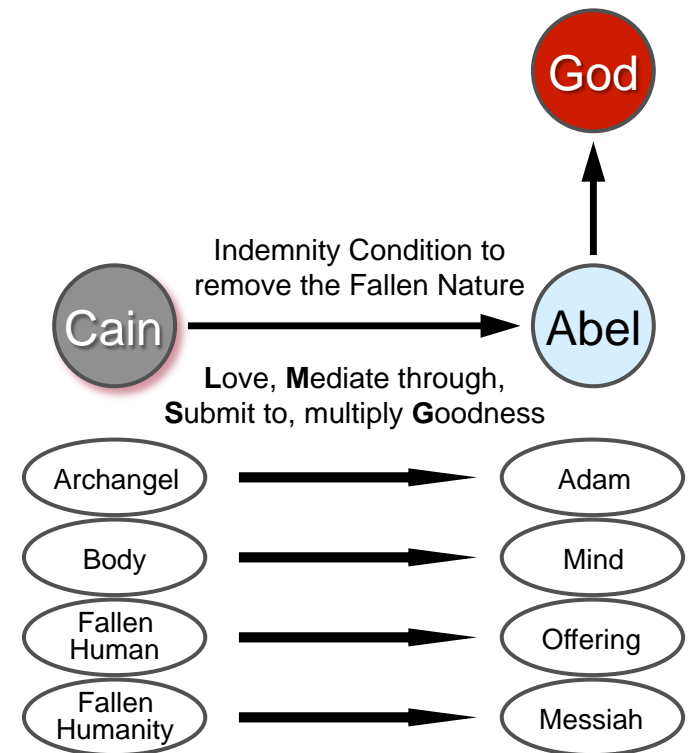

3) The Reason God Accepted Abel's Offering and Rejected Cain's Offering

(1) Abel { Separated younger son
In Adam's position

Adam is able to approach God directly.

∴ God accepted Abel's Offering

(2) Cain { Separated firstborn son
In the Archangel's position

The Archangel is not able to approach God directly.

∴ God cannot accept Cain's Offering directly

- (3) God's acceptance of Abel's offering shows us that even sinners are able to make offerings that God can accept, provided those offerings are made in a manner that matches God's Will.
- (4) Even in the case of a fallen human being, if a condition that God can claim is established, God will accept it.
- (5) If someone who is standing on Satan's side wants to return to God's side, in all cases, that person must establish some type of indemnity condition.

2. The Foundation of Substance

1) Central Figure: Abel

2) Condition: Indemnity Condition to remove the Fallen Nature

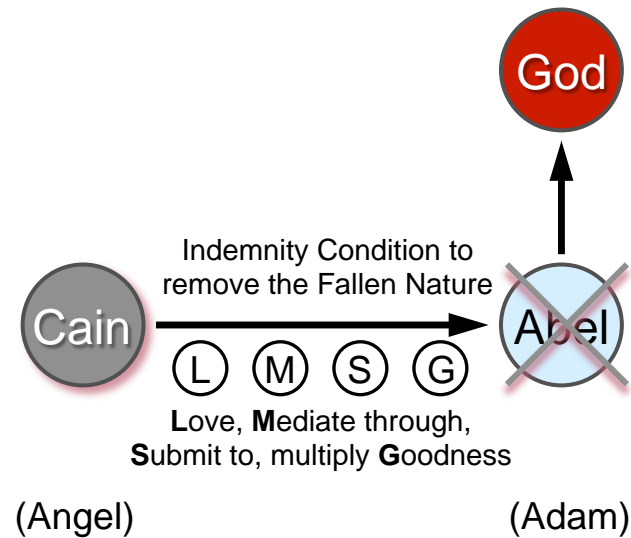

3. Results

- (1) Foundation of Faith: success
- (2) Foundation of Substance: failure (Cain murders Abel)
- (3) Foundation for the Messiah: not established (providence prolonged)
 - i. Human History: History of the separation of good and evil
 - Fallen human – the womb of both good and evil
 - ii. Human History: History of the struggle between good and evil
 - Fight between the side of good and the side of evil
 - (Until the time that good is established)
 - God's side receives the blows, but then takes and reclaims.
 - Satan's side strikes and loses what he has.
 - iii. Evil dominates and governs over good.
 - iv. Evil makes its beginning first: Cain murders Abel.

4. The Sins of Adam's Family: The Root Source of the Sins of Humankind

- 1) Parents: the sin of disbelief
 (the sin of rebellion)
 the sin of immorality
- 2) Children: the sin of murder

- 3) The Archangel: { the sin of disbelief
 (the sin of rebellion)
 the sin of lying
 the sin of immorality
 the sin of theft



These form the contents
of humanity's sins
(The central focus of the
Ten Commandments)

- (1) Thou shalt have no other gods but God
- (2) Adultery ✘
- (3) Murder ✘
- (4) Theft ✘ (Greed ✘)†
- (5) Do not bear false witness (Lie)†

II. Lessons

1. Lessons about the Principle

- 1) God's predestination and attitude towards the accomplishment of His Will:
God does not interfere with the human portion of responsibility.
- 2) God's predestination regarding His will is absolute:
God carried out a new providence to establish Seth in place of Abel.

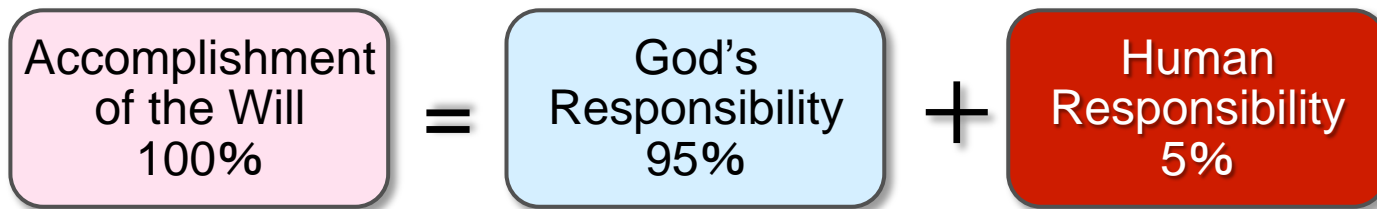

2. Lessons to Take Note of

1) Abel: Do not be arrogant, be meek and mild, humble, don't be boastful or proud, sacrifice (blood, sweat, tears).

Abel's Responsibility

- Must love Cain absolutely
(Must convey God's love and practice God's love)
- Must bring Cain to a natural and voluntary surrender

2) Cain: Even if you desire to kill someone, restrain yourself and resist that impulse.

(Do not grumble and complain, do not harbor feelings of being unloved, ignored)

Killing Abel may bring some momentary release, but you will be unable to enter into the Kingdom of Heaven (if you murder him, you are hell-bound).

Cain's Responsibility:

- Must obey and submit to Abel absolutely
(Cain receives the blessing through Abel).
- Have self-control and govern oneself with patience, perseverance and endurance.

3. The Law of Cain and Abel

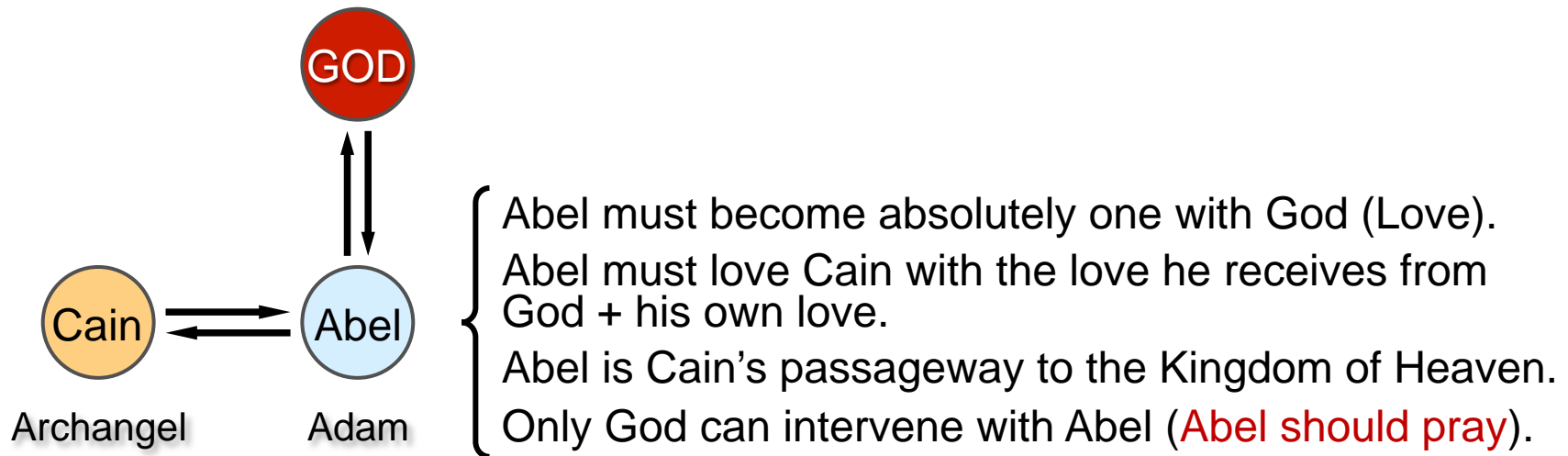

Cain must become absolutely one with Abel.

Cain must avoid feeling a lack of love or indulging in feeling unloved, uncared for.

Cain goes before God via Abel (Goes to the Kingdom of Heaven via Abel)

Cain must learn the life of loving God and loving others and living for others through Abel.

Conclusion: I myself am sometimes Abel and sometimes Cain.

Accordingly, I have to clearly understand the Law of Cain and Abel and practice it in my life.

4. The Attitude that Leads to the Kingdom of Heaven

- 1) Abel: Should think about Cain's *shimjung* and feelings as much as possible (that is, love Cain)
(Good people should walk the path of sacrifice in order to rescue evil people.)
- 2) Cain: Enters the Kingdom of Heaven through Abel.
Cain must sever his reciprocal connection with Satan (that is, separate from Satan).
If Cain wishes to believe in God and go towards God, he must sever his relationship with Satan.
 - Abel = The Roots
 - Cain = The Soil

5. Everything is Decided in an Instant

Treat each instant as precious.

The Relationship between each instant and our entire life

- End -

The Providence of Restoration Centering on Noah's Family

Introduction

The providence of restoration centering on Adam's family could not be accomplished due to Cain's murder of Abel. Nevertheless, because God had predestined his Will to perfect and fulfill the purpose of creation as an unchangeable and absolute Will, God established Seth in Abel's place, based on the foundation of the loyal heart Abel had demonstrated towards Heaven (Gen 4:25). Accordingly, God chose Noah's family from among Seth's descendants to substitute for Adam's family and then carried out a new dispensation of providence for restoration.

As recorded in the scripture of Genesis 6:13 - "And God said to Noah, 'I have determined to make an end of all flesh; for the earth is filled with violence through them; behold, I will destroy them with the earth.'" – God carried out the flood judgment. Considering this, we can understand that the days of Noah were also a period of the 'Last Days'.

I. The Foundation for the Messiah

Fallen human beings must be restored to the state in which they were originally created. For this to happen, they must establish a relationship with the Messiah. To establish a relationship with the Messiah, human beings must first establish the Foundation for the Messiah. If there is no Foundation for the Messiah, fallen people will kill the Messiah when he comes.

The Foundation of Faith

- i. Central Figure: Noah
- ii. Object for the Condition (Symbolic Offering): The Ark
- iii. Time Period: 120 years, 40 days, 21 days, 40 days

The Foundation of Substance (Substantial Offering)

- i. Central Figure: Ham
- ii. Condition: Indemnity Condition to Remove the Fallen Nature

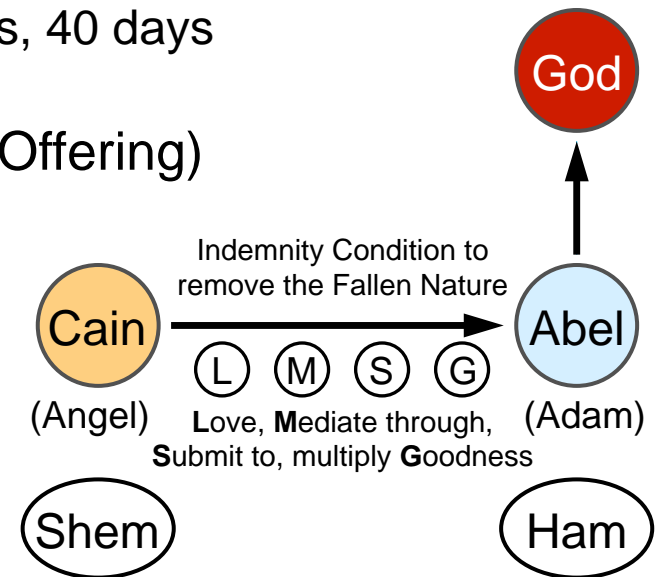

1. The Foundation of Faith

- i. Central Figure: Noah (The 1st father of faith, 10 generations, a righteous man, a descendent of Seth)
- ii. Object for the Condition: The Ark (Symbol of the new Heaven and Earth)
- iii. Time Period: 120 years, 40 days, 21 days, 40 days

1) The Meaning of the Ark (a Symbol of the New Heaven and Earth)

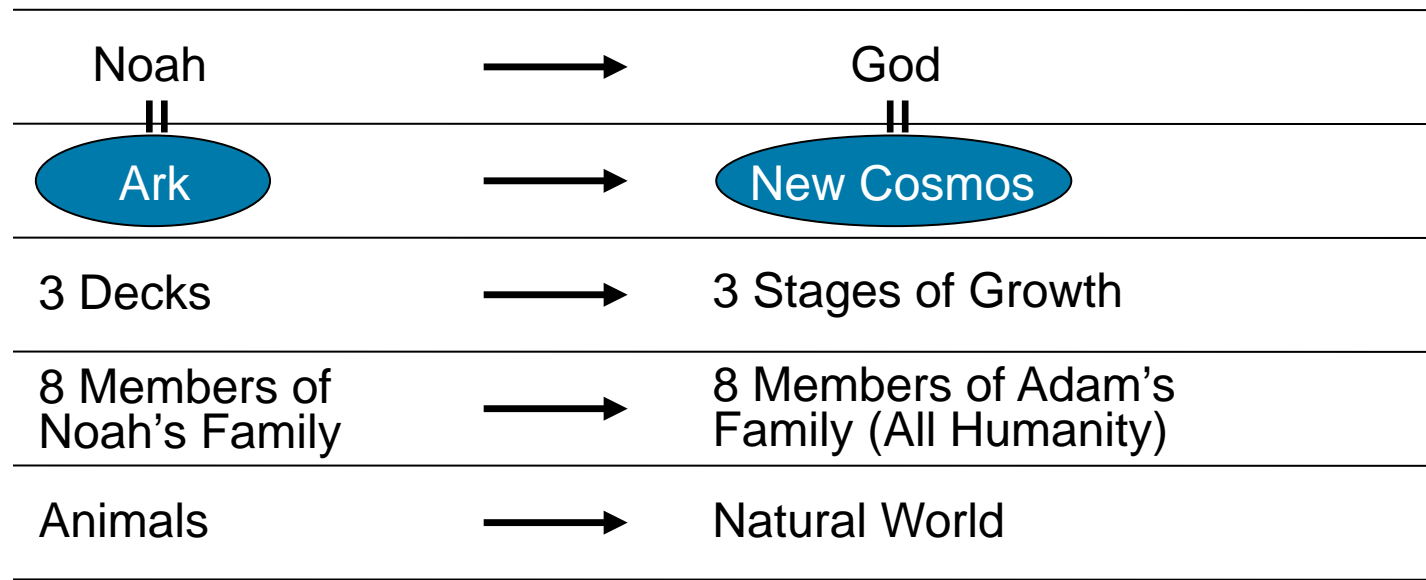

2) 40 Day Flood Judgment (Separation of Good and Evil)

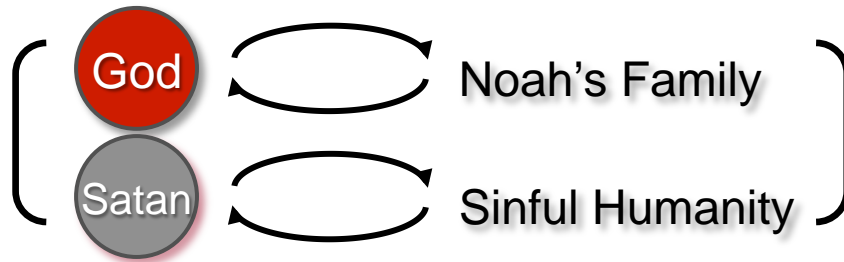

Significance of the Number 40

Following the Flood Judgment, in all courses of the Providence of Restoration through Indemnity, the Number 40 became necessary as a numerical figure for separating from Satan so that the Foundation of Faith can be restored.

E.g.) Noah's 40-day flood judgment; 400 years from Noah to Abraham; the 400 year period of Israelite slavery in Egypt and the 400 year period of Christian persecution under the Roman Empire; Moses' 40-day fast; 40 days of spying in Canaan; 40 years of wandering in the wilderness by the Israelites; 40-year reigns of Kings Saul, David and Solomon; Elijah's 40-day fast; 40-day period of Jesus' resurrection

40-day period of the Flood Judgment= Period of chaos after the creation of universe
The Works of God following the Ark = Symbolize the entire course of history that followed God's creation of Heaven and Earth

3) The Works of God following the Flood Judgment

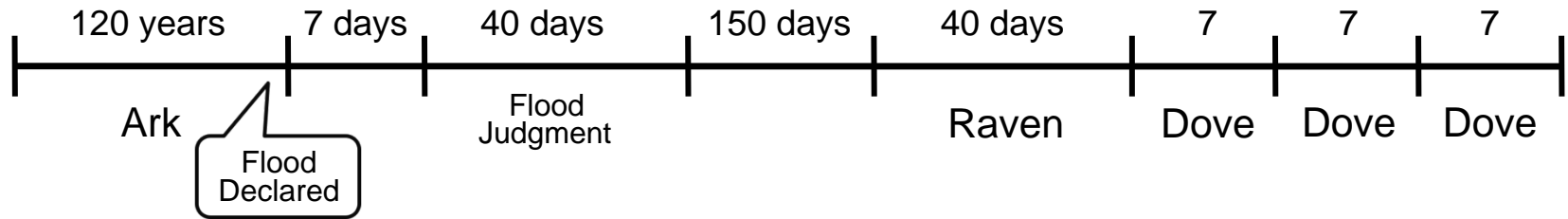

- Ark → Symbolized new cosmos
- 40-day Flood → Formless, Emptiness (Gen 1:2)[†]
- Raven → Symbolized Satan

Archangel – Had designs on Eve’s love
 Satan – Cain’s, Abel’s Offerings (Gen 4:7)[†]
 Satan – Had designs on Noah’s Family after the Judgment

Third Dove	Third Adam	Symbolized the Second Coming	Did not return	God’s Will shall be realized on the earth
Second Dove	Second Adam	Symbolized Jesus	Olive branch (Promise)	If the people did not have faith, Jesus would die on the cross
First Dove	First Adam	Symbolized Adam	Returned	Symbolizes fallen Adam, God withdrew His ideal from the earth

2. The Foundation of Substance

1) Central Figure: Ham

(1) In order that Ham could stand as the central figure for the foundation of substance, the position of the second son had to be restored. To accomplish this, Ham had to become one in heart with Noah, who had successfully accomplished the foundation of faith (Genesis 9:20-26).[†]

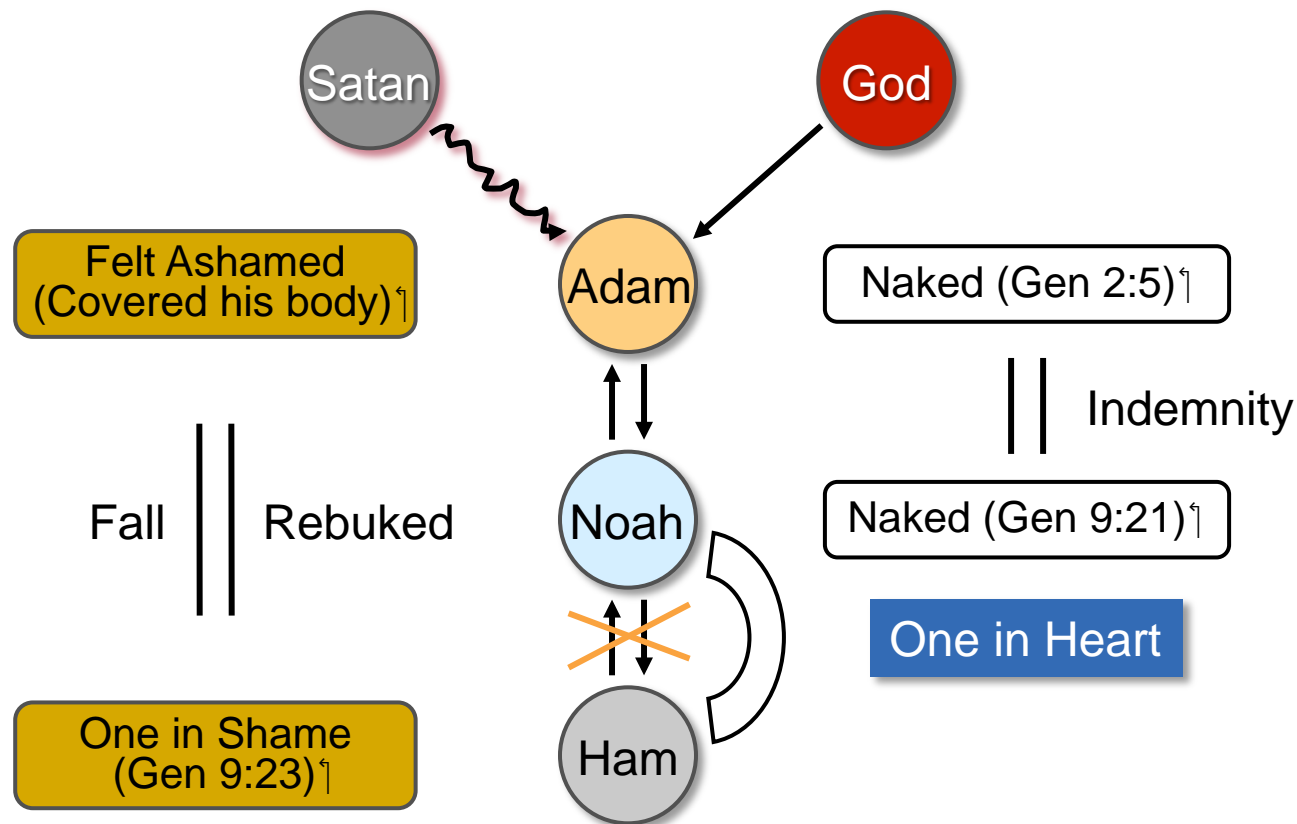

(2) The Reason why Ham Feeling Ashamed was a Sin

i. What is Sin?

Sin is the formulation of standard that allows a reciprocal relationship with Satan and which creates a condition for Satan to act through the violation of Heavenly Law.

Prior to the Fall: naked but not ashamed
Following the Fall: ashamed of nakedness

The feeling of being ashamed created a condition for Satan to act

ii. Noah's family was to restore Adam's family.

- { Adam's family → Adam lost faith (disbelief)
- { Noah's family → Noah established faith (father of faith)
- { Prior to the fall, Adam & Eve were naked but were not ashamed.
After the fall, Adam & Eve were ashamed of their nakedness and covered themselves (sin).
- { Noah's family → had to remain unashamed of Noah's naked body and not cover him.

iii. Ham was unable to become the central figure for the foundation of substance.

3. Result

The Foundation of Faith was successful, but due to Ham's mistake, the Foundation of Substance failed.

Accordingly, the Foundation for the Messiah in Noah's family failed.

II. Lessons

1. Lessons about the Principle

1) God's Will is absolute, but fulfillment thereof is relative (it requires a human portion of responsibility).

2) God's predestination regarding human beings

God established Abraham's family in the place of Noah's family and carried out a new providence.

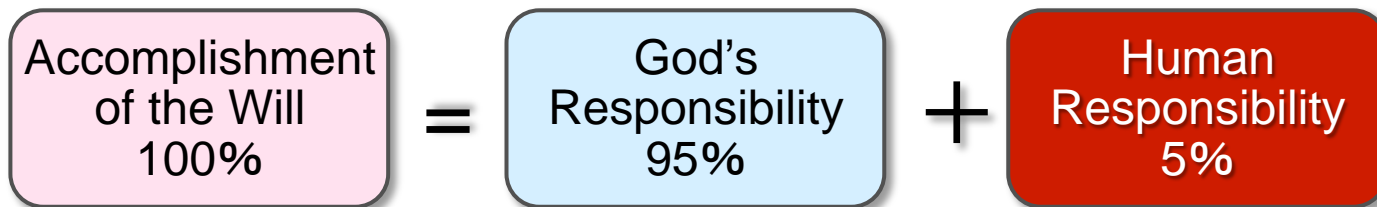

2. Lessons to Take Note of

Do not act simply according to your own way of thinking.
If you do not know, ask. God will teach you when the right time comes.

3. The Attitude that Leads to the Kingdom of Heaven

Be meek, mild and persevere (wait until the right time comes).
Be grateful, and joyful.

4. Everything is Decided in an Instant.

The Relationship between each instant and our entire life

- End -

The Providence of Restoration Centering on Abraham's Family

Introduction

As a result of Ham's fallen act, the providence of restoration in Noah's family was not fulfilled. On the other hand, God had absolutely predestined his Will to accomplish the purpose of creation. Therefore, on the basis of Noah's loyal heart towards Heaven, God called Abraham, who was the son of Terah, an idol seller, someone who was in the position to be most loved by Satan. Centering on Abraham's family, God recommenced his providence of restoration.

I. The Foundation for the Messiah

Fallen human beings must be restored to the state in which they were originally created. For this to happen, they must establish a relationship with the Messiah.

To establish a relationship with the Messiah, human beings must first establish the Foundation for the Messiah.

If there is no Foundation for the Messiah, fallen people will kill the Messiah when he comes.

The Foundation of Faith

- i. Central Figure: Abraham
- ii. Object for the Condition (Symbolic Offering): The 3 Offerings
- iii. Time Period

The Foundation of Substance

- i. Central Figure: Isaac (Jacob)
- ii. Condition: Indemnity Condition to Remove the Fallen Nature

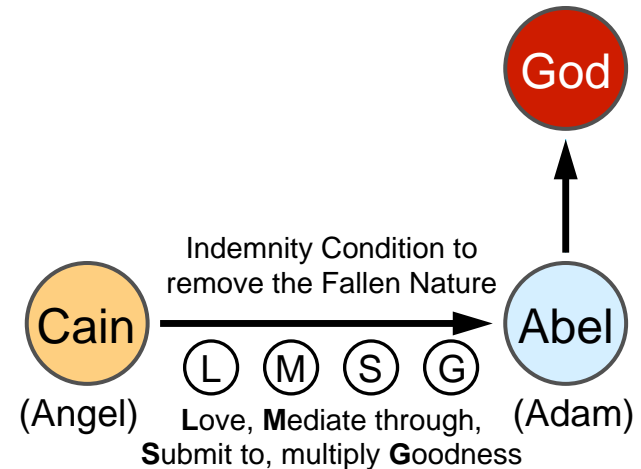

1. The Foundation of Faith

1) Central Figure: Abraham

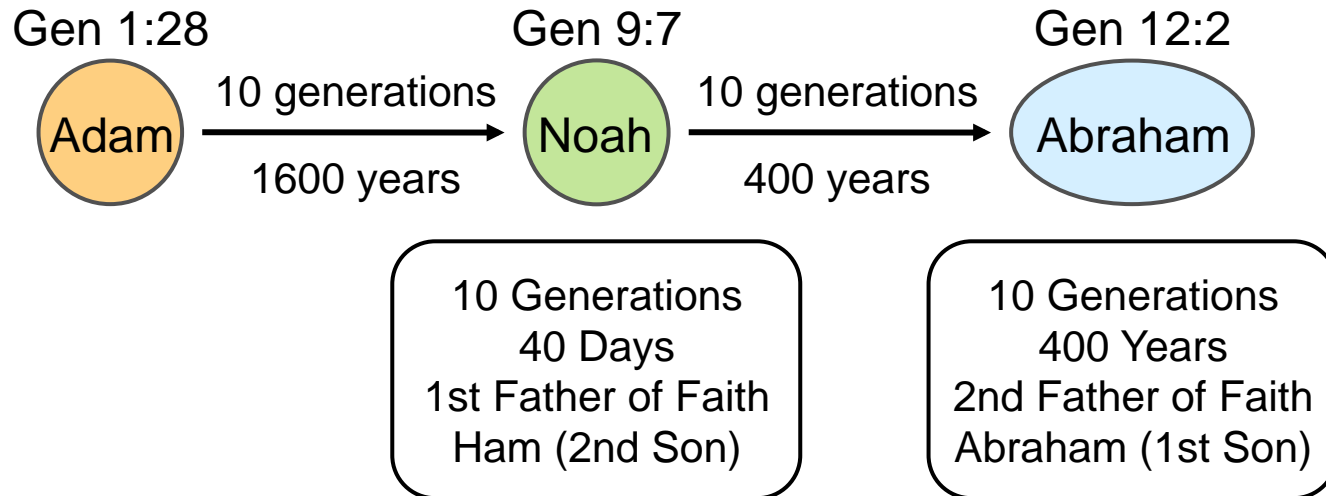

Ur of the Chaldeans → Haran → Canaan
(Iraq) (Syria) (Israel)

Equal to Noah building the Ark for 120 years

1) Adam's Family's Situation

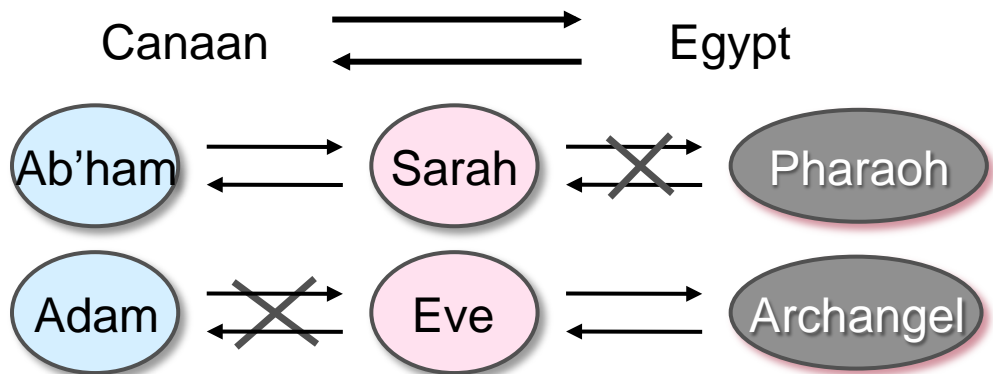

2) Noah's Family's Situation

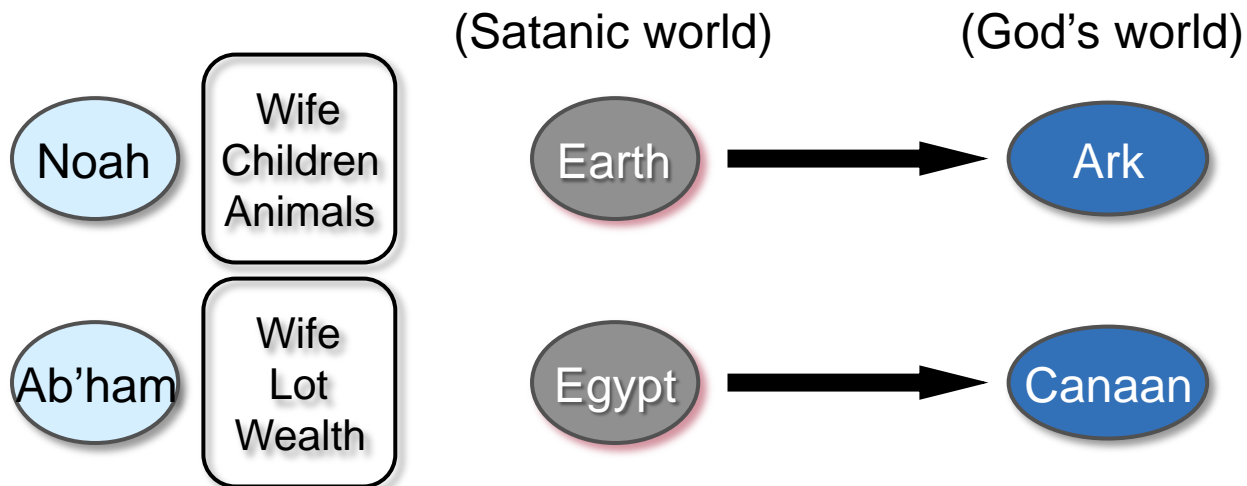

Abraham confirmed as the Central Figure for the Foundation of Faith
Is able to make the Symbolic Offering

2) Symbolic Offering

(1) Abraham's Three Sacrifices: Symbolized the Cosmos perfected through the 3 stages

Heifer	Symbol of the completion stage	Judges 14:18	The Second Coming	The completion stage, Completed Testament Providence
Goat & Ram	Symbol of the growth stage	John 1:29	Jesus Christ	The one who initiates the growth stage, New Testament Providence
Dove & Pigeon	Symbol of the formation stage	Matthew 3:16	Jesus Christ	The one who completes the formation stage, Old Testament Providence (Matt 5:17)

Judges 14:18: "If you had not plowed with my heifer, you would not have solved my riddle..."

Revelation 19:7: Feast of the Lamb (Age of the Wife is the Age of the Heifer)

(2) Meaning of the Three Sacrifices

- i. Symbol of the perfected cosmos that is completed through process of the three stages of growth
- ii. Intended to restore horizontally and in one event all the vertical providential indemnity conditions that had accumulated through the three generations of Adam, Noah and Abraham
- iii. Intended to restore through indemnity all the conditions which signified the number three and which had been invaded by Satan, thereby completing the entire providence of restoration in a single stroke

(3) How was Abraham to make the symbolic offering?

Abraham should have cut (divided) all the symbolic offerings into two pieces, but actually failed to cut the dove and pigeon in two.



(4) Meaning of Dividing Offerings (Gen 15:8-13)†

➡ Separation of Good and Evil

(Purpose of the providence of salvation is restoration of the sovereignty of goodness)

- i. Adam's Family → Separation of Cain and Abel (Adam being the womb of good & evil)
- ii. Noah's Family → Separation of Noah's family from the people of the sinful world (centered on the ark, judgment by flood, separation of good & evil)
- iii. Abraham's Family → Separation of the world of Satan's sovereignty from God's sovereignty
- iv. Sanctifying the offering by removing the blood of death (a condition to sanctify the offerings of the blood of death that entered into humankind through the blood relationship which Adam and Eve had with Satan)

(5) Effect of Not Dividing Offerings

➡ No Separation of Good and Evil (Remained under the sovereignty of evil)

- i. Following the creation of humankind → The Archangel targeted human beings
- ii. Adam's Family → Satan targeted Cain and Abel at the time of their offering
- iii. Noah's Family → Satan targeted Noah's family after the flood
- iv. Abraham's Family → Satan targeted Abraham's family after the symbolic offering



**Symbol
Of Satan**

(6) Result of the Failure of the Symbolic Offering

- i. Failed to restore the Foundation of Faith
- ii. 400 years of slavery in Egypt (period of punishment, period for separation of humanity)
Necessary to indemnify the 400 years from Noah to Abraham
- iii. Providence prolonged over 3 generations through Isaac to Jacob (Offering of Isaac)

If the symbolic offering had been successful, the Foundation of Substance would have been laid centering on Ishmael and Isaac.

3) Abraham's Offering of Isaac

- Abraham – The key figure of failure (Just as Adam was the key figure of the fall)
- A Core Ground Rule of God's Providence – If someone fails their role as a central figure, God does not use that person as a central figure again.
- Nonetheless, God commanded Abraham who failed in the symbolic offering to sacrifice Isaac (Gen. 22:2).[†]

(1) The Basis on Which Abraham could Offer the Symbolic Offering Again

- i. There is a condition in Principle that the providence to lay the Foundation for the Messiah must be completed at the third attempt.
- ii. Because Satan invaded the two generations of Adam and Cain, the principle of restoration through indemnity allowed God to be able to restore the two generations of Abraham and Isaac.
- iii. The heartistic (*shimjung*) foundation established by Abel and Noah through the successful completion of their symbolic offerings was a condition by which God could work to have Abraham offer the sacrifice again.

(2) Conditions for Abraham's Offering of Isaac

1) Adam's Family's Situation

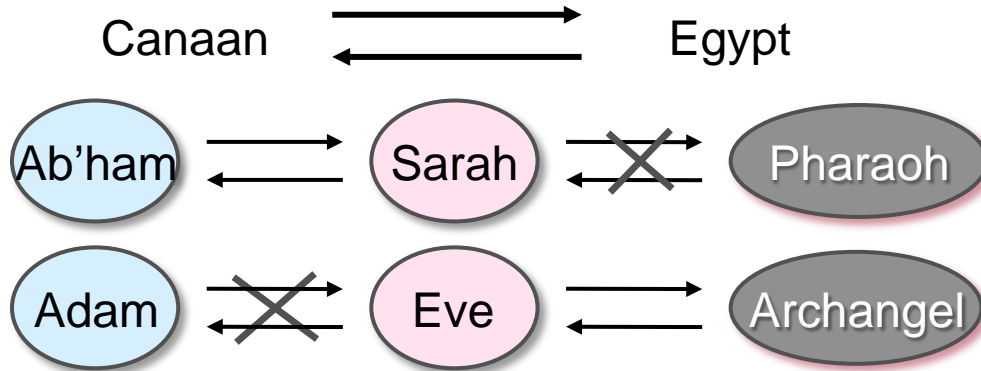

2) Noah's Family's Situation

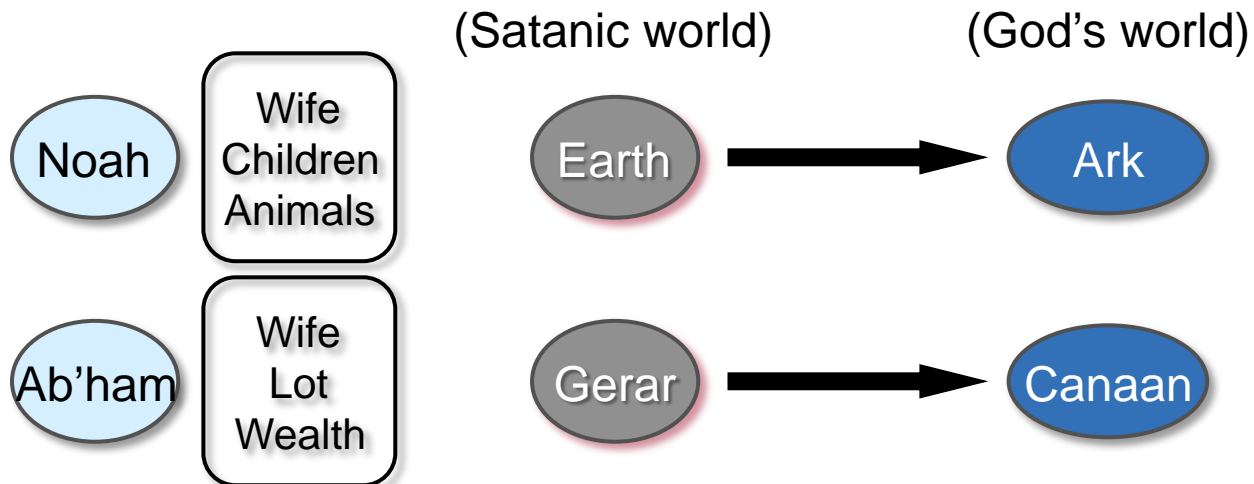

(3) Offering of Isaac

- i. 3-day course – period for separation of Satan (when making a new start)
- ii. Intention to kill – to separate Satan from Isaac
- iii. Not killing Isaac – because Isaac had been separated from Satan
Abraham's absolute faith (heart of loyalty)
Isaac's absolute faith (heart of obedience)
- iv. "Now I know..." (God's heart of reproach for Abraham's failure in the symbolic offering, God's joy at Abraham's success in the offering of Isaac)

(4) The Effect of Successfully Offering Isaac

- i. Abraham dies symbolically, Isaac becomes the resurrected Abraham.
- ii. Abraham and Isaac become as one person.
- iii. Isaac can now make the symbolic offering as the central figure for the foundation of faith.

(5) The Foundation of Faith Centering on Isaac

- i. Central Figure: Isaac (Abraham)
- ii. Object for the Condition: Ram (Genesis 22:13)

1. The Foundation of Substance

1) Central Figure: Jacob (restoration of Adam's family)

(1) Individual: Restoration of the Birthright

- ┌ Elder brother Esau → to restore the birthright of the elder son
- └ Father Isaac → to receive the Blessing

(2) Family: Restoration of the family in Haran

- ┌ Haran = Symbol of the Satanic world
- └ Laban = Satan in substance

- i. Laban's 2 daughters and their 2 handmaids = 4 wives
(Leah, Rachel) (Zilpah, Bilhah)
(6 + 2) (2 + 2) = 12 sons

- ii. Finding servants = restoration of the archangel

(3) Governance over Creation: Restoration of wealth and assets

- i. Jacob's family escapes

- ii. They took the idols that Laban loved when they left.

Destruction of the idols (buried them under an oak after the 3-day course had passed)

- iii. Fought with the angel at the Ford of Jabbok and was victorious
= "Israel" (the angel's blessing)

2) Condition: Substantial Offering

Indemnity Condition to Remove the Fallen Nature

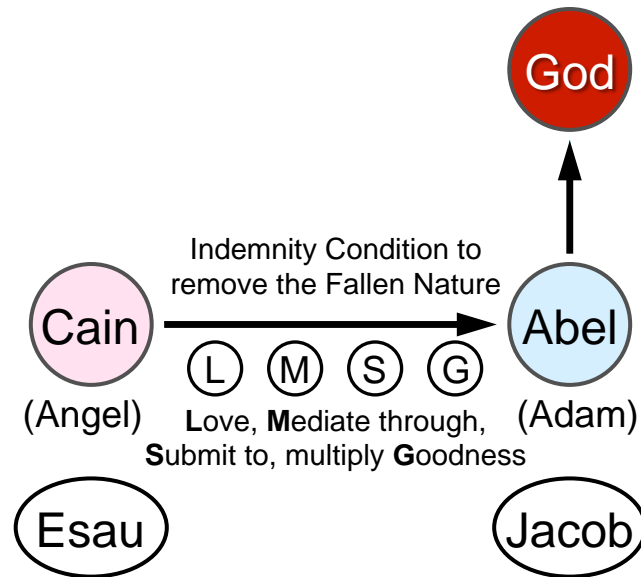

(1) The reunion of Jacob and Esau
(Gen 33:1-12)

(2) Foundation of Substance
Successful

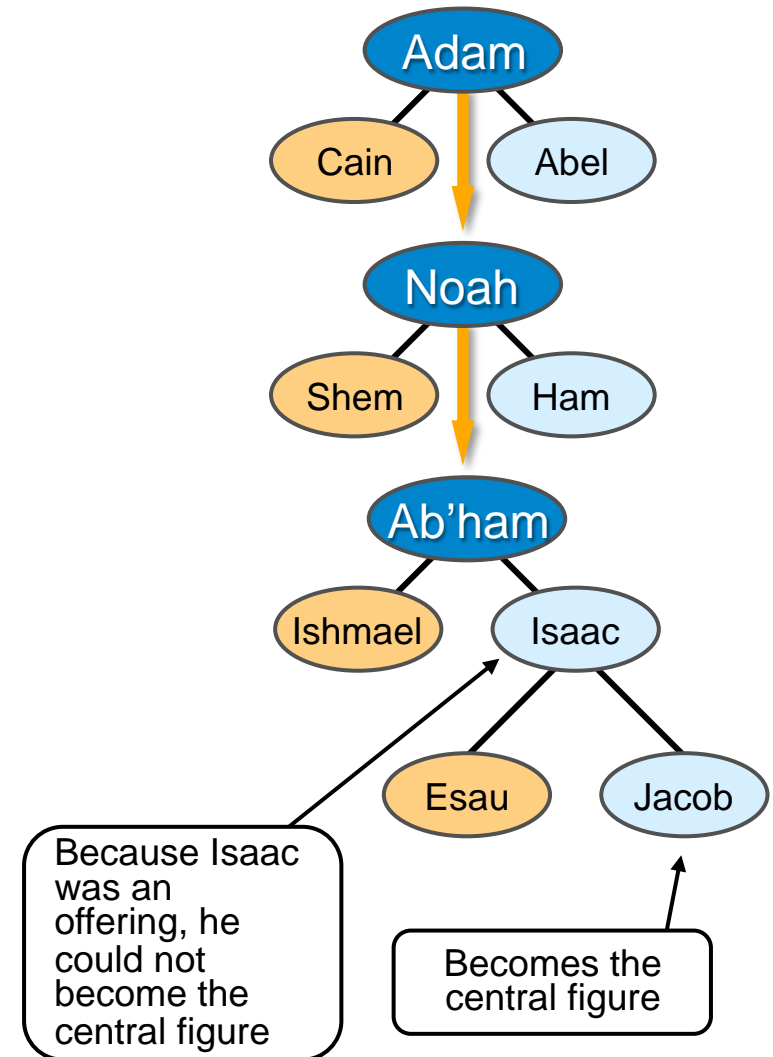

3) The Impact of Jacob's Victory

(1) Isaac's family horizontally restored the entire vertical course of history that started with Adam's family and which had the purpose of restoring through indemnity the foundation of substance.

(2) As a result of Jacob's victory:

- i. Origin of the Chosen People (Abraham's descendants become the Chosen People)
- ii. Through Jacob, God's Side (Abel) comes to subjugate Satan's Side (Cain).
- iii. Jacob's course becomes the model course for subjugating Satan's side.
- iv. The history of the chosen people of Israel becomes the central history of the providence of restoration.
- v. The God of three generations (Exodus 3:6): From the perspective of providence, these three generations are the same as one generation.

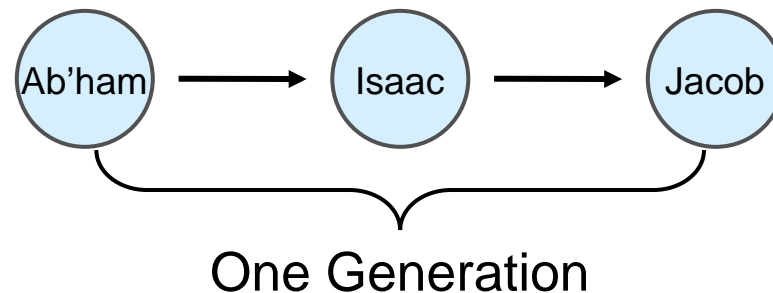

The person who must walk the central path in all courses for indemnification is the Abel-type figure who stands as the center of the offering of substance (Abel, Ham, Isaac, Jacob, Joseph).

(3) The Reasons why Abraham's family became the Chosen People and the Messiah came to them.

Adam's
Family



Restored
Thru Indemnity
In Abraham's
Family

- i. Adam, Eve → The Sin of Immoral Sex
- ii. Cain, Abel → The Sin of Murder
- iii. Archangel → The Sin of Lying (The Sins of Rebellion and Theft)

- i. Abraham, Isaac → Restoration of Eve
(Did not commit the sin of immoral sex)
 - Abraham, Sarah → Maintained absolute sex
(Did not commit the sin of immoral sex)
 - Isaac, Rebekah → Deceived father and elder son so Jacob could receive the blessing
- ii. Jacob, Joseph → Restoration of Adam
(Did not commit the sin of immoral sex)
- iii. Joseph → Indemnified the Sin of Murder
(Loved his enemy, restored the wealth)

Jacob's victory is the origin and genesis of the chosen people.
As a result of his victory, Christ came to Chosen People of Israel.

(4) The Reasons why Christ could not come at that time, even though the Foundation for the Messiah was successful.

1) The Foundation for the Messiah was established through Jacob's victory, but...

{ Satan's side – Ethnic group-level foundation

{ God's side – In the process of establishing a family-level foundation, the Messiah can only be sent when an ethnic group-level foundation has been established.

2) Abraham's failure in making the symbolic offering

→ Abraham's descendants were still required to complete 400 years of slavery in Egypt.

The Foundation for the Messiah had been successfully established in Abraham's family, but Christ still could not come → God's providence extended and lengthened

(5) The Foundation for the Messiah must be maintained up until the time the Messiah is sent.

- i. The unity between Esau and Jacob was necessary up until the time that the Messiah is sent.
- ii. Jacob's family (12 sons, 70 family members) entered into travail in Egypt, but Esau's family was not included. This became a condition that Satan might be able to invade.

As a result, in the future, when the Messiah came, Satan had a condition to strike him. Accordingly, in order to separate Satan, God sent the prophet Elijah to Israel and had him defeat 450 prophets of Baal and 400 prophets of Asherah on Mt. Carmel and then destroy them.

However, the wife of King Ahab, Queen Jezebel refused to submit and sought to kill Elijah. Elijah fled and after traveling for 40 days and 40 nights, spent the night in a cave on Mt. Horeb. Eventually, later on, a chariot of fire and horses of fire appeared and Elijah ascended to heaven on a whirlwind.

As a result, because Satan would be able to strike Jesus Christ in the future, God gave the prophecy that he would first send Elijah the Prophet (Malachi 4:5).

The person to fulfill the mission of Elijah was John the Baptist. Unfortunately, despite being prepared, John the Baptist fell into disbelief, the Jewish leaders fell into disbelief, the chosen people of Israel fell into disbelief, and even Jesus' disciples fell into disbelief. As a consequence, Jesus Christ ended up dying on the cross.

In the end when the Second Coming of Christ comes after 2000 years of preparation by God, there is still a condition that Satan might attack him, and as such, at the time of the Second Coming, it will also be necessary for someone who can fulfill the mission of Elijah to appear.

II. Lessons

1. The human portion of responsibility is always necessary for the Will to be accomplished.

2. Lessons to Take Note of

- i. A small failure - requires a larger condition of indemnity to be established.
- ii. I must always separate good and evil within myself.
- iii. Mother-son cooperation
- iv. Pay attention to small things – Negligence becomes the cause of failure.

3. The Attitude that Leads to the Kingdom of Heaven

- i. Jacob → to invest everything possible for the sake of Esau – blood, sweat and tears, dedication, effort (21 years)
- ii. Esau → Obedience, submission

4. Everything is Decided in an Instant.

Treat each instant as precious.

The Relationship between each instant and our entire life

Comparison of the Courses of Adam, Noah and Abraham

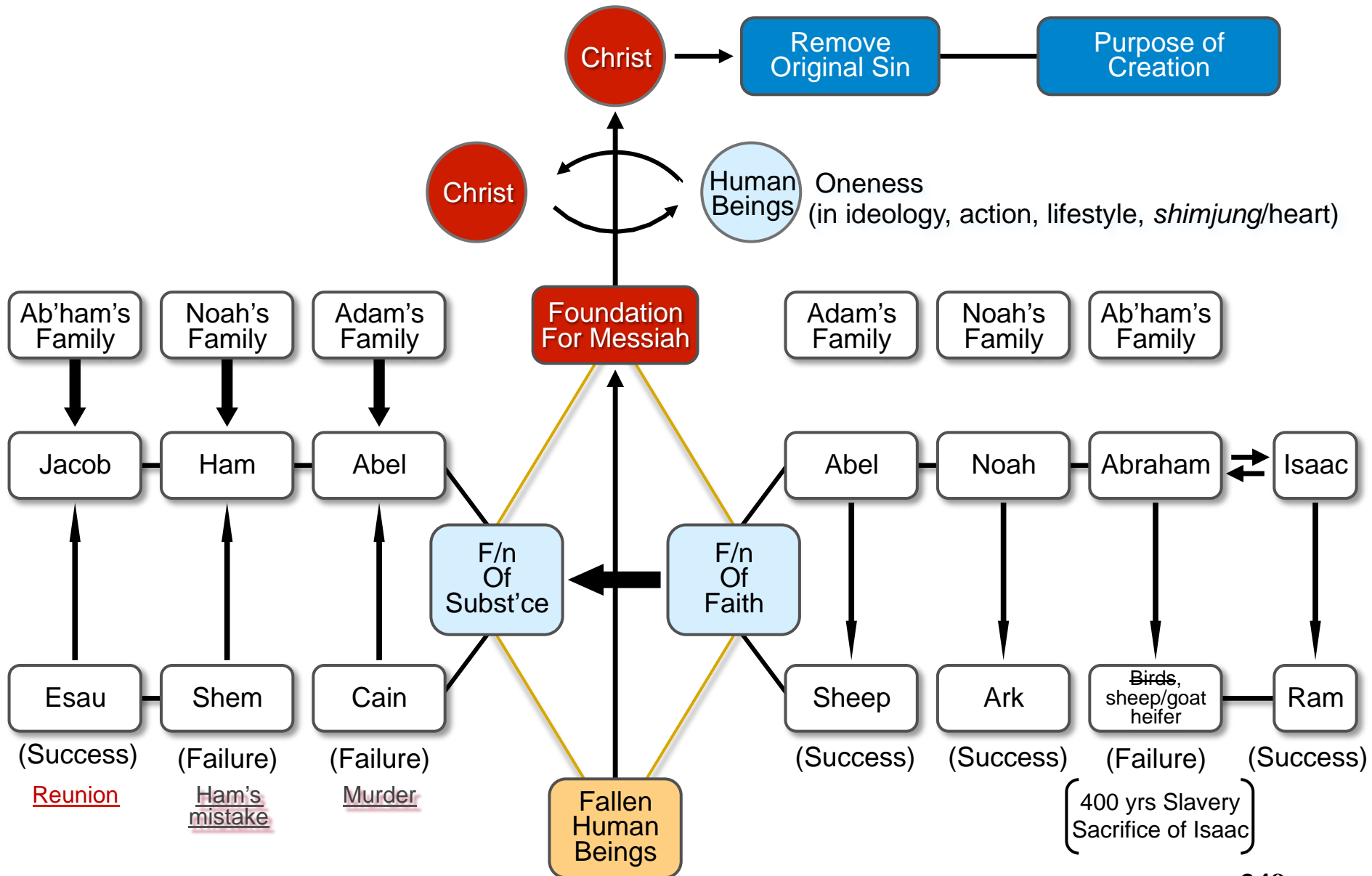

The Providence of Restoration Centering on Moses

Introduction

1. The Providence of Restoration centering on Moses and Jesus

Amos 3:7 : "Surely the Lord God does nothing, without revealing his secret to his servants the prophets."

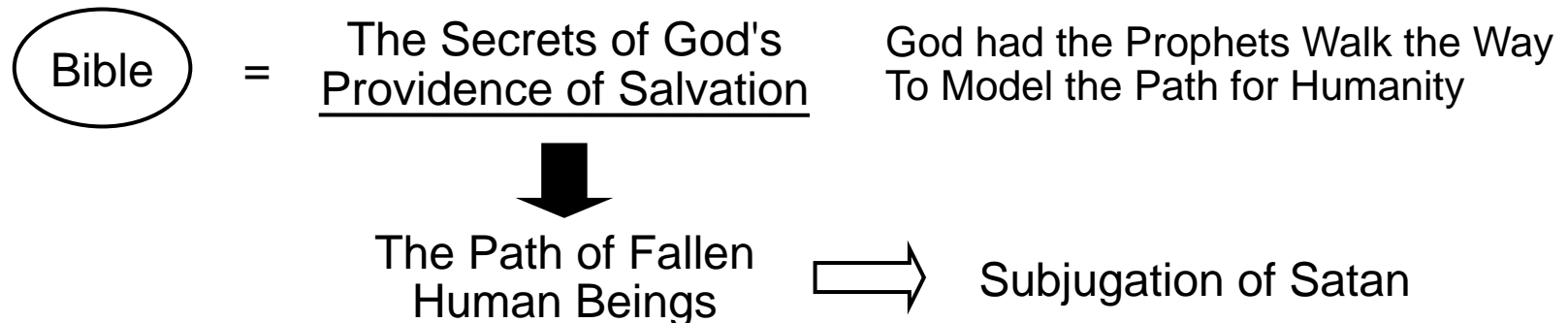

- i. Jacob :
(Symbolic Course) Model course for bringing Satan to submission by bringing Esau to submission (Amos 3:7)
- ii. Moses :
(Image Course) Course for bringing Satan to submission on the Ethnic Group level (Acts 3:22)
- iii. Jesus :
(Substantial Course) Pioneered the course to substantially and actually bring Satan to submission, educated humanity so that they could walk that path and bring Satan to submission (John 5:19)

2. The Model Course for Bringing Satan to Surrender

- 1) The Reason God established Jacob's Course and Moses' Course as the Models for Jesus' Course

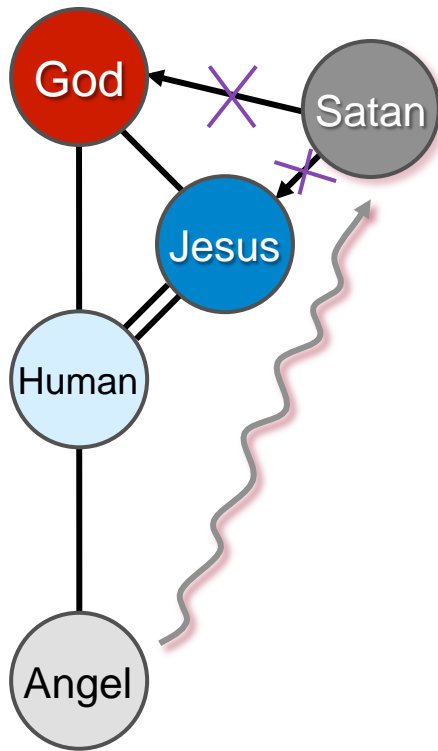

- i. There is no way that Satan, who refuses to obey and submit to God, would voluntarily submit to Jesus or his disciples.
- ii. God takes responsibility in the Principle for having created human beings. Therefore, as the parent, he took it as his portion of responsibility to establish the courses of Jacob and Moses and through them reveal the model course for how Satan is to be brought to surrender.
- iii. Jesus Christ came as the ancestor of humankind to bring Satan to surrender by walking the way revealed in the courses of Jacob and Moses. Faithful believers must walk the way according to Jesus' course to also bring Satan to surrender.

2) Moses Course and Jesus Course as walked with Jacob's Course as the Model (Concrete Comparison of the Model Course to Bring Satan to Submission)

	Adam Course of the Fall	Jacob's Course Symbolic (Family-type)	Moses' Course Image (Ethnic Group-type)	Jesus' Course Substantial (National)	
1	Tested	Wrestle with Angel (Gen 32:25)	The Lord seeks to kill Moses (Exod 4:24-26) [†]	The Three Temptations	
2	Flesh & Spirit	Bread & lentil stew (Gen 25:34)	Manna & quail (Exod 16:13~14) [†]	Jesus' flesh & blood	
3	Corpse	Separation of corpse for 40 days (Gen 50:3)	Separation of corpse (Jude 1:9)	Separation of corpse (Resurrection) (Matt 28:12~13)	
4	Restoration of numbers {	3 Stages	3-day course (Gen. 31:22) [†]	3-day course (Exod 5:3) [†]	3-day course (Luke 18:33) [†]
		12 Gen	12 sons (Gen. 35:22)	12 tribes (Exod 24:4) [†]	12 disciples (Matt 10:1) [†]
		7 Days of Creation	70 family members (Gen 46:27)	70 elders (Exod 24:1) [†]	70 followers (Luke 10:1) [†]
5	Staff	Jabbok River (Gen 27:43)	Red Sea (Exod 14:16)	Turbulent waters (Rev 12:5, 2:27)	
6	Mother/Son Cooperation	Mother/son cooperation (Gen 27:43) [†]	Mother/son cooperation (Exod 2:2)	Mother/son cooperation (Matt 2:13) [†]	
7	Restoration of Canaan	Haran → Canaan (Gen 31:33) [†]	Egypt → Canaan (Exod 3:8) [†]	Egypt → Canaan	
8	Destruction of Satan	Idols → Buried under an oak tree (Gen 35:4) [†]	Idols → Golden calf (Exod 32:20) [†]	Words and power 353	

I. Overview of the Providence of Restoration Centering on Moses

The laws governing the providence of restoration are the same

1. Differences with the Previous Providence

- i. Family level → Ethnic Group level (scope of the provident changed)
- ii. Era for the Providence to lay the Foundation for Restoration → Era of the Providence of Restoration
- iii. Symbolic offering → Centering on the work of God (Conditions of indemnity)

2. Moses' Position (Unique and Special Aspects)

- i. Representative body of God (Exod 4:16, 7:1) Moses = God
- ii. An image of Jesus (Gen 37:5~11) God incarnate = Jesus Christ
- iii. Moses' course – Archetypical course to be followed by Jesus Christ

┌ Moses – Image-type course (Deut 18:18) Growth, demise
└ Jesus – Substantial course (John 5:19) Growth, demise

3. Dispensation is prolonged three times due to the disbelief of the people

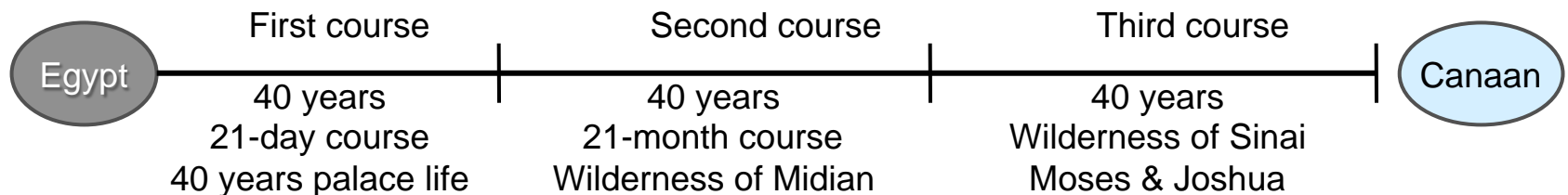

Map of Route of the Israelite Exodus



Mediterranean Sea

Jericho

Ford of Jabbok

Canaan

2 spies

Jordan

3 Days

Shitim

Dead sea

Rameses

1st Course (21 days)

3-day Course

(Fire & Cloud)

Kadesh-barnea

12 spies

Succoth

(Manna & Quail)

2nd Course (21 months)

3 Months

Nile R.

Riphidim

SINAI

3 Months

Egypt

Red Sea

Wilderness Of Midian

12 Months

Mt Sinai

II. The First Ethnic-Group Level Course to Restore Canaan

1. The Foundation of Faith
 - i. Central figure = Moses (Pharaoh)
 - ii. Conditional Object = 40 years of palace life (loyalty, filial piety, righteousness)

2. The Foundation of Substance
 - i. Central figure = Moses
 - ii. Condition = Indemnity condition to remove the fallen nature
(The Israelites had to love, mediate through, submit to and multiply goodness from Moses)

3. Providence for the Start
 - Killing of an Egyptian**
 - i. to show the Israelites Moses' patriotic heart and have them believe in him
 - ii. to cut off Moses' emotional attachment to the Pharaoh's palace
 - iii. to restore through indemnity by hitting the satanic side, which stood in the position of the elder son

Egypt

The entire period

→

Course of faith of all humankind
Must walk in the spirit of absolute faith, love and obedience

Canaan

Disbelief of Israelite People (Exod 2:15) → Prolonged to a 21-month course (Exod 13:17)

III. The Second Ethnic-Group Level Course to Restore Canaan

1. The Foundation of Faith
 - i. Central figure = Moses (Jethro)
 - ii. Conditional Object = 40-year period in the wilderness of Midian (Exod 3:7-10 Moses called)

2. The Foundation of Substance
 - i. Central figure = Moses
 - ii. Condition = Indemnity condition to remove the fallen nature
(The Israelites had to love, mediate through, submit to and multiply goodness from Moses)

3. Providence for the Start

The Three Great Miracles and the Power of the Ten Plagues

 - i. To restore through indemnity the position of the elder son which had been invaded by Satan
 - ii. To cut off the emotional attachment which the Israelite people felt towards Egypt
 - iii. In order to have the Israelites believe that Moses had been sent by God
 - iv. The 400-year indemnity period of slavery in Egypt had already been completed (30 years previously) (Exodus 12:41)
 - v. The lamentation of the Israelites had reached God's heart (Exodus 2:24-25)

1) Person Representing the Word (Exodus 4:10)

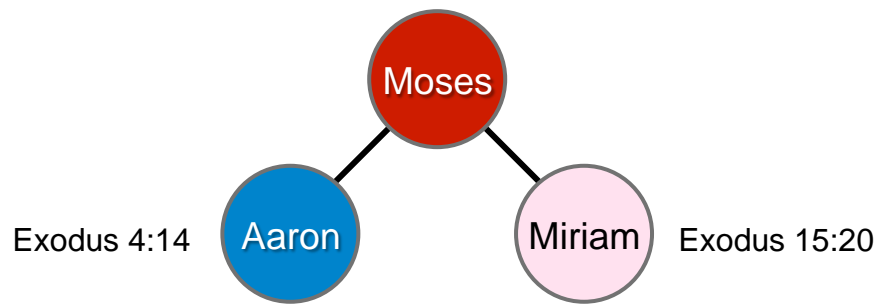

(Persons representing the Word)

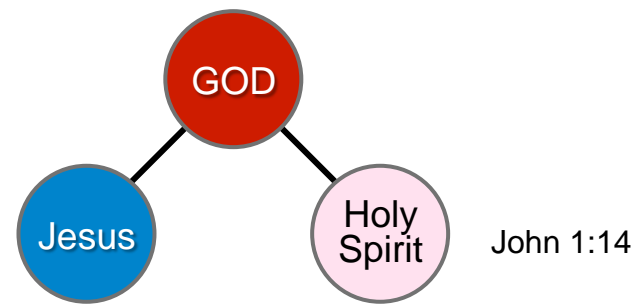

(Incarnation of the Word)

2) God sought to kill Moses (Circumcision)

God sought to kill Moses → Moses' wife Zipporah circumcises their son

- Reason
- i. To heartistically indemnify Adam's betrayal towards God
 - ii. To set up a condition that Moses started the course based on his own will
 - iii. To foreshow that Jesus would also survive through mother/son cooperation

3) Circumcision

Circumcision of Moses' son → salvation of the family → Made possible the Israelite Exodus
At the time of Jesus → circumcision of Israelite people → make God's salvation possible

(1) The meaning of circumcision

- i. Signifies removal of the blood of death
- ii. Signifies the restoration of men's capacity to govern
- iii. Signifies the restoration of children as they were originally created by God

(2) Three types of circumcision

- i. Circumcision of the heart (mind) (Deuteronomy 10:16)
- ii. Circumcision of the foreskin (Genesis 17:10)
- iii. Circumcision of all things (Leviticus 19:23)

4) The Three Great Miracles (Exod 4:3-9)

(1) Aaron's Staff → Serpent (Restoration of Adam)

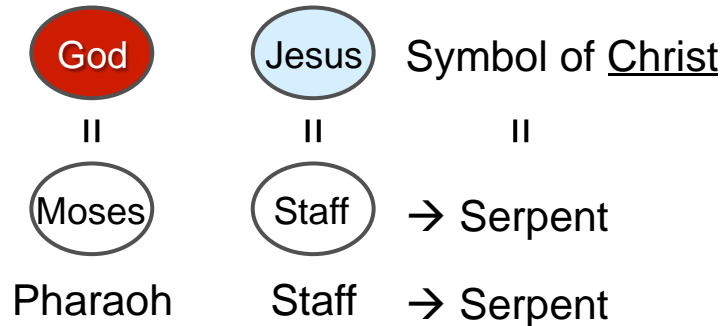

Meaning of the Staff
Support, Protection, Guidance
(John 3:14, Matt 10:16, Wisdom)

(2) Moses' hand → leprous (Restoration of Eve)

Incurable disease = The Fall of Eve

Complete recovery (Complete restoration) = Symbol of the Holy Spirit

Restoration of Holy Spirit – Work of Atonement – Atonement of Sins of all Humankind

(3) Water of the Nile → Blood (Restoration of Children)

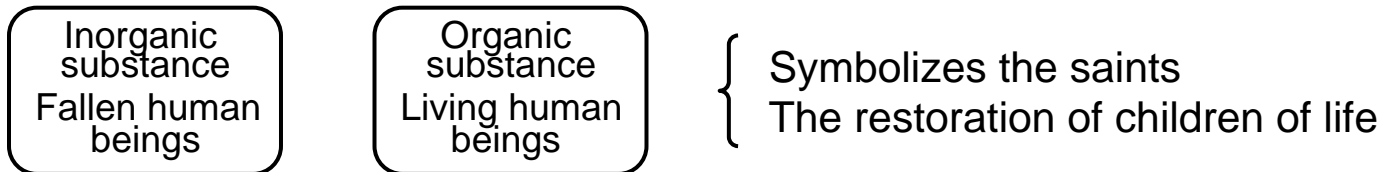

**Result: Restoration of the Four Position Foundation
(Restoration of the Three Blessings)**

5) The Ten Plagues (Exodus 7:14-11:10)

- (1) Meaning: Foreshadows that Christ would come and save the chosen people with miracles and Heavenly authority
- (2) Reason: Jacob was deceived ten times by Laban in Haran (Genesis 31:7)
At the time of Moses → Egyptians deceived the Israelites ten times (30 years)
- (3) Details
 - i. The water of the Nile was struck → changed into blood (Exodus 7:17)
 - ii. Frogs (8:2) iii. Dust → Gnats (8:16) iv. Flies (8:21)
 - v. Livestock suffering plague, dying (9:3)
 - vi. Tumors (9:9) vii. Hail (9:18) viii. Locusts (10:4)†
 - ix. Darkness (10:22) x. Striking the firstborn of the Egyptians (11:5)
- (4) God hardening Pharaoh's heart
 - i. Pharaoh: maximum opposition to the Israelites (Emotional attachment, powerlessness) → natural surrender
 - ii. Israelite people (ethnic group) → cut off their emotional attachment to Egypt

By destroying the Satanic side and bringing victory for God's side, God demonstrated to the Israelites that he was on their side

4. The Exodus Course (Exodus 8:28)

- (1) 3-day course
- (2) The pillar of cloud & the pillar of fire
- (3) Staff – The Red Sea
- (4) Manna and quail
- (5) The rock and water at Rephidim
- (6) The battle with the Amalekites

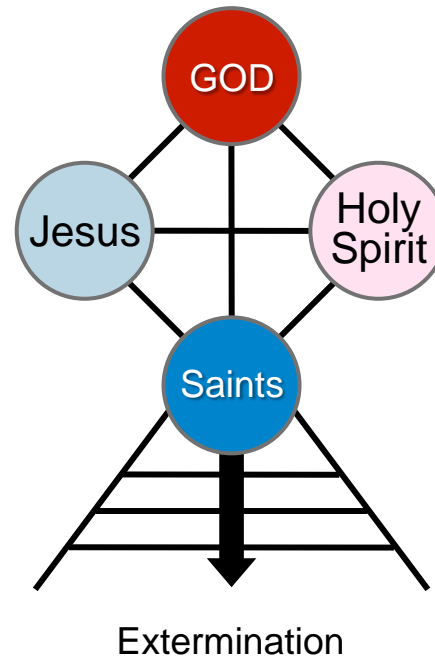
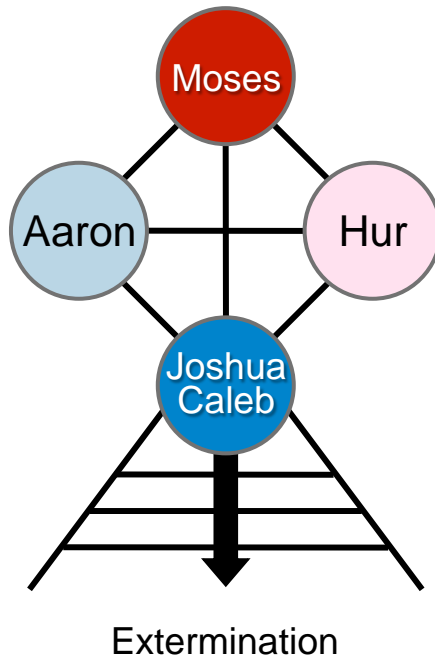
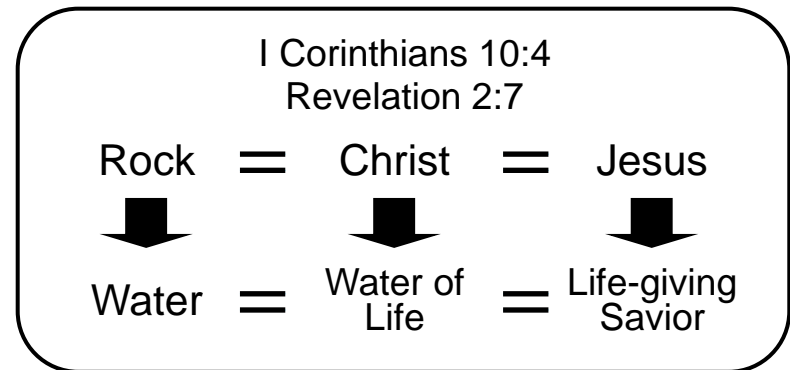

5. The Providence of Restoration centering on the Tabernacle

- 1) 40-day Fast and the Two Tablets of Stone
- 2) The meaning of the two tablets of stone and the Tabernacle
 - (1) Two Tablets of Stone: Jesus Christ and the Holy Spirit = Heaven & Earth
 - (2) The Tabernacle: **Symbolic Messiah**
 - (3) The Structure of the Tabernacle

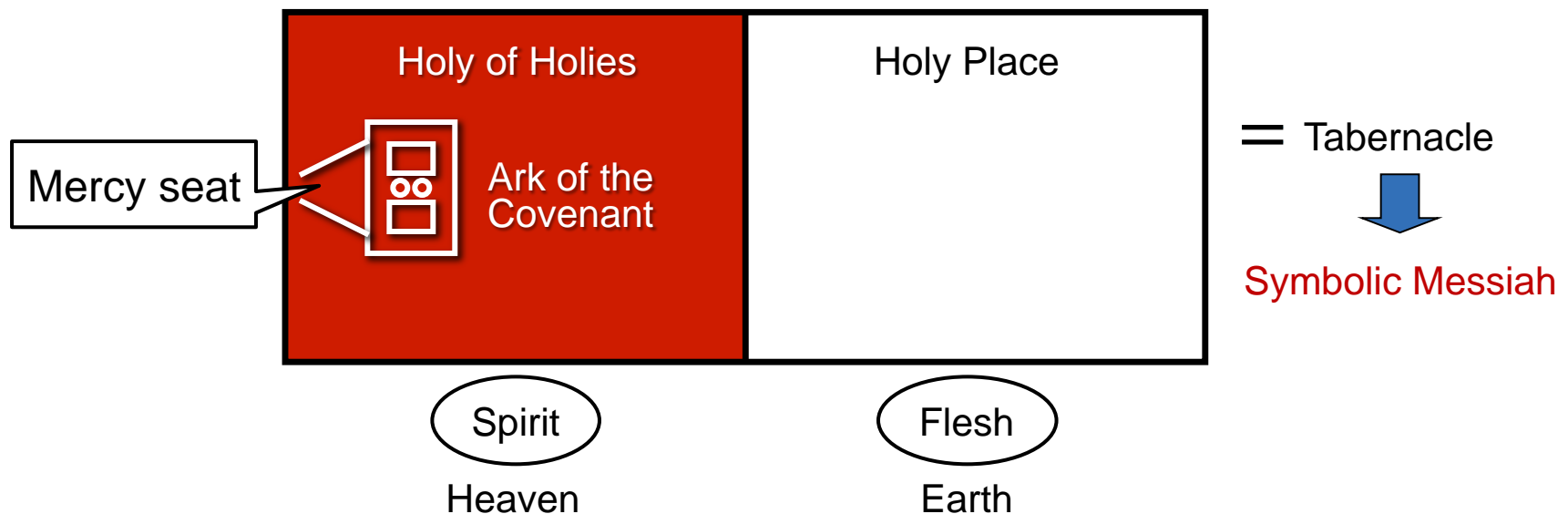
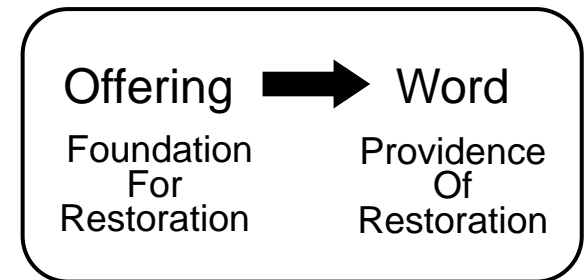

3) Ark of the covenant (placed in the holy of holies)

- (1) Two tablets of stone: Jesus and the Holy Spirit (symbols of Heaven & Earth)
- (2) Manna: Nourishment for the Israelites, symbol of Jesus' Christ's body (golden urn)
- (3) Golden Urn: symbol of the glory of God
- (4) Aaron's rod that budded: demonstrated God's power to the Israelites

4) On a large scale, a miniature of the cosmos, on a small scale, a miniature of the Tabernacle

- (1) The mercy seat was placed above the Ark of the Covenant.
- (2) Two cherubim made of hammered gold: when these were placed on either side of the mercy seat, God would appear between these and give his guidance to the Israelites.
- (3) The Fall of Adam: the way to the Tree of Life was blocked by a cherubim.
- (4) This foreshadowed that when this cherubim was divided left and right, anyone could come before Jesus Christ, the Tree of Life, and receive God's Word.

(5) The Holy of Holies – where the high priest could enter and make an offering once a year

Matthew 27:52 - The veil in the tabernacle was torn in two when Jesus died.



This signified that the way was now open for heaven and earth to communicate with each other through Christ (in spirit and flesh).

(6) God's providential purpose in granting the tabernacle to the Israelites

- i. The Israelite people → to complete the restoration of Canaan
- ii. The people → continued to disbelieve
- iii. Moses → is human, and therefore might fall into disbelief
- iv. An unchanging object of faith was required, because as an object, a human being might fall into faithlessness.
- v. As long as even one person kept faith in the tabernacle, then this object of faith could be passed on like a baton in a race. In this way, God intended to accomplish the purpose of the providential Will.

Construction of the Tabernacle = The Messiah Had Arrived Symbolically

5) The Tabernacle (Symbolic Messiah)

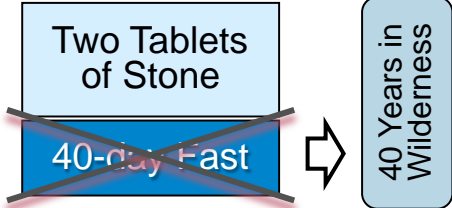
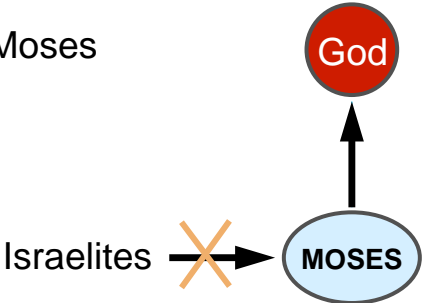
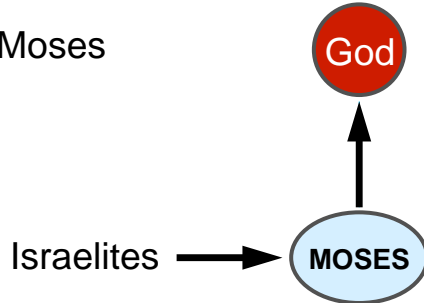
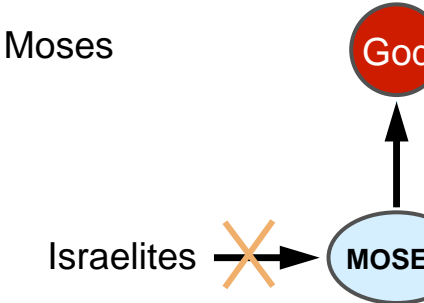
		First Foundation for the Tabernacle	Second Foundation for the Tabernacle	Third Foundation for the Tabernacle
Foundation of Faith	Central Figure	Moses	Moses	Moses
	Object for Condition	40 Day Fast 	40 Day Fast 	40 Day Spying 
Foundation of Substance	Central Figure	Moses	Moses	Moses
	Condition	 Israelites: Golden calf centered on Aaron Moses: Rage, broke the tablets of stone (Exod 32:9)	 The 2 nd Foundation for the Tabernacle successful Israelites fell into faithlessness after departing from Mt. Sinai	 (12 Tribal Leaders) 10 Leaders disbelief, 2 Leaders belief 10 tribes (representing the Israelites as a whole) disbelief

Result: Second Ethnic-Group Level Course to Restore Canaan Failed

IV. The Third Ethnic-Group Level Course to Restore Canaan

1. The Providence Centered on Moses

1) The Foundation of Faith

- i. Central figure = Moses
- ii. Conditional Object = 40 years of wandering in the wilderness of Sinai (honoring the tabernacle with faith and loyalty)

2) The Foundation of Substance

- i. Central figure = Moses
- ii. Condition

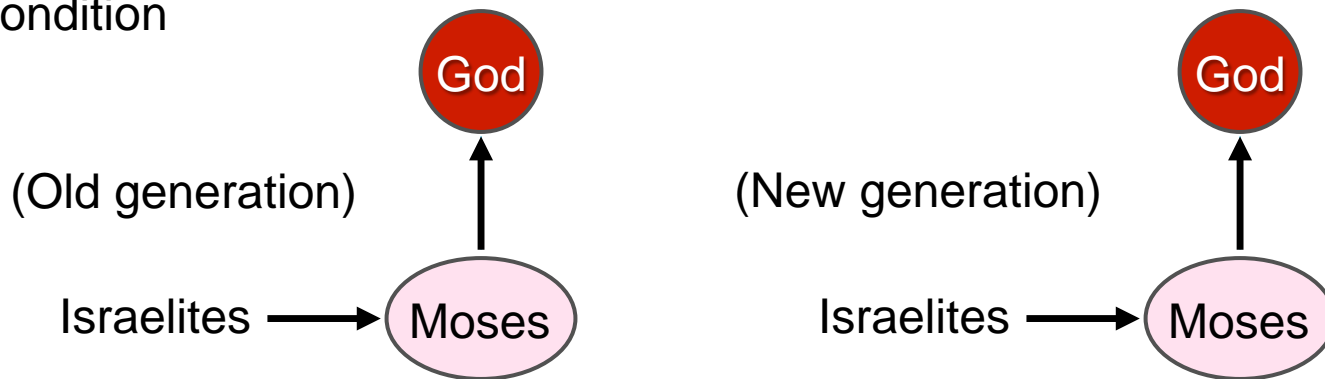

3) Providence for the start: Water from the Rock

4) Striking the Rock Twice

(1) The reason why Moses striking the rock twice was a sin

- i. It established a condition that enabled Satan to invade if the people (ethnic-group) fell into faithlessness.
- ii. Striking the rock twice was an act that signified the possibility of striking Jesus Christ, who was to come as the rock in substance. Therefore, it was a sin.
- iii. Thus, Moses striking the rock twice became a cause of the crucifixion of Jesus.

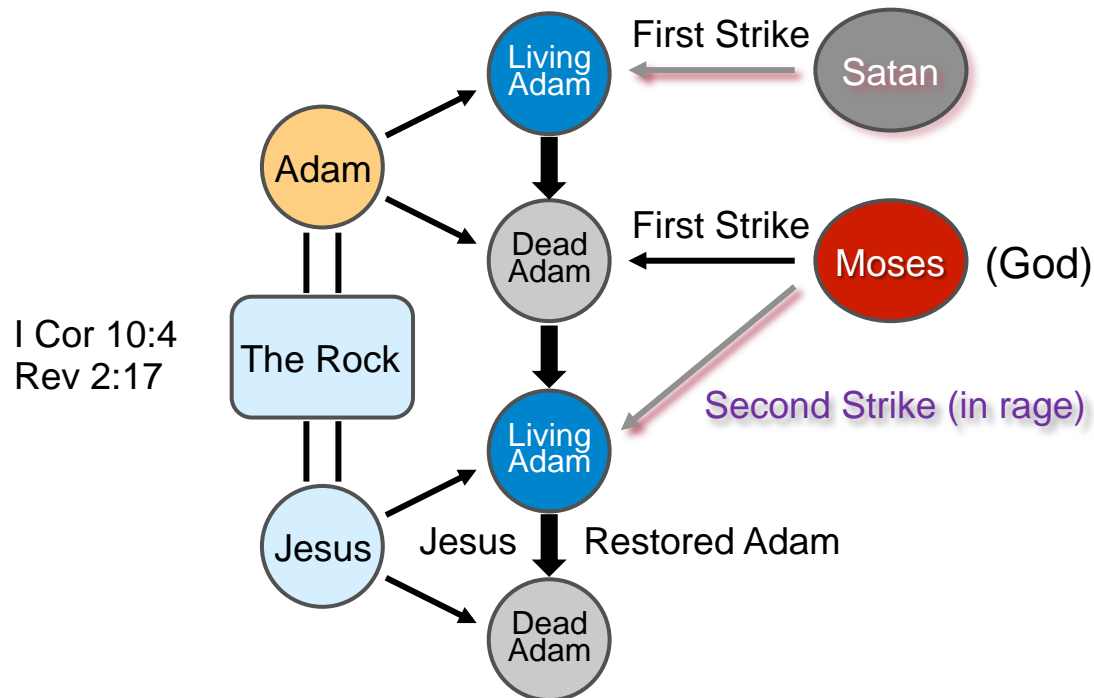

Moses – faithlessness of the people → broke the tablets of stone → foreshadowed possibility that Christ might be crucified

Jesus – faithlessness of the people → resulted in Jesus dying on the cross

(2) The reason that the Two Tablets of Stone could be recovered but Moses' striking the Rock twice could not

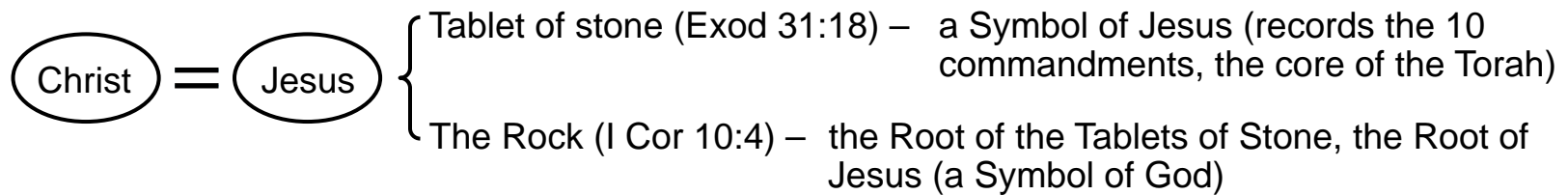

The action symbolized striking God, who is the root of the tablets of stone (Jesus), so there was no one who could recover this. It could not be restored.

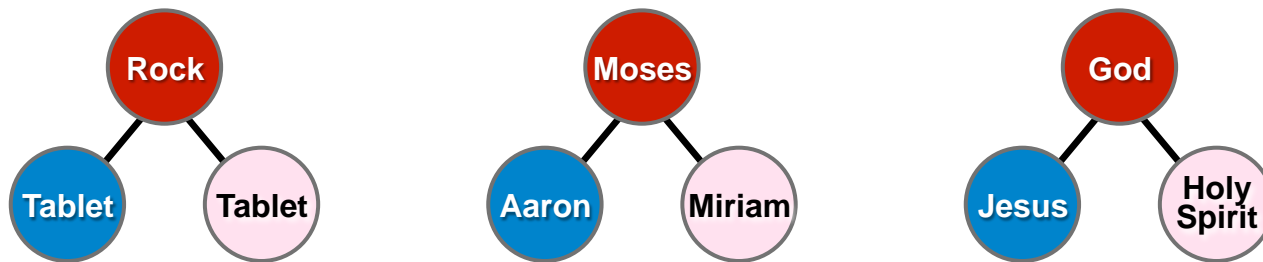

(3) The reason that water still came from the rock even though Moses struck it twice (sin)

- The internal foundation that the people had drunk the water from the rock at Rephidim during the Second Course
- Although Satan invaded Moses' externally unfaithful action, Moses' internal heart and shimjung towards God was unchanging.
- There was a foundation of absolute faith towards the ideal of the tabernacle and attendance towards the Ark of the Covenant (the devotion of Joshua and Caleb).

(4) Results of striking the rock twice

- i. Internal Israelites → Entered Canaan, External Israelites → Died in the Wilderness (Deut 34:4~5)
- ii. Disbelief of the People (ethnic-group) → Satan possessed the Rock, The Rock in Substance, Jesus, suffered the three temptations of Satan (Matt 4:1-11)
- iii.

iii. <u>Moses</u>	{	flesh – death	<u>Jesus</u> (substance	{	flesh –	Crucified
		(struck Rock x			of the Rock)	spirit –
		entered Canaan			spirit –	Resurrection
						(salvation)
- iv. **Fiery serpents** killed faithless people in the wilderness, **Moses** - bronze serpent → **salvation** of a repentant people (John 3:14)
When the **Jewish** people disbelieved in Jesus → Jesus raised on the **Cross** → **salvation** of a repentant people
- v. Following Moses striking the Rock twice
 - a. Moses: struck twice due to faithless people → Unable to enter Canaan (Num 20:12) → Prayed desperately and implored God (Deut 3:25) → Died looking upon Canaan → Location of body **unknown** following death (Deut 34:6)
 - b. Jesus: disbelief of the people (ethnic-group) → Hung upon the Cross → Prayed to be able to avoid that path (Matt 26:39) → Died on the Cross → Location of body **unknown** following death
- vi. Joshua inherited Moses' mission

2. The Foundation of Substance Centering on Joshua

1) Spying Out Jericho

Two scouts reported faithfully → The Israelites became one centering on Joshua.

The prostitute Rahab hides the two scouts, spying completed on the foundation of the hearts of the two spies

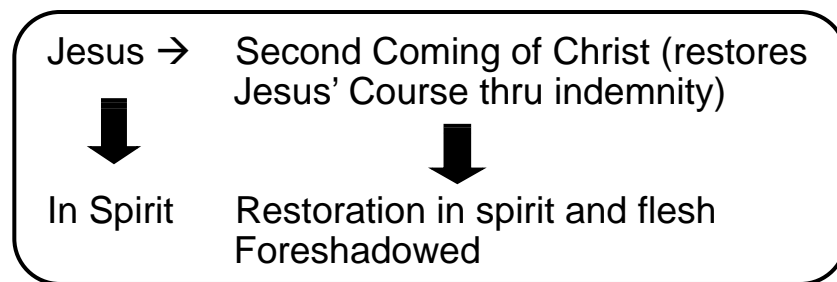
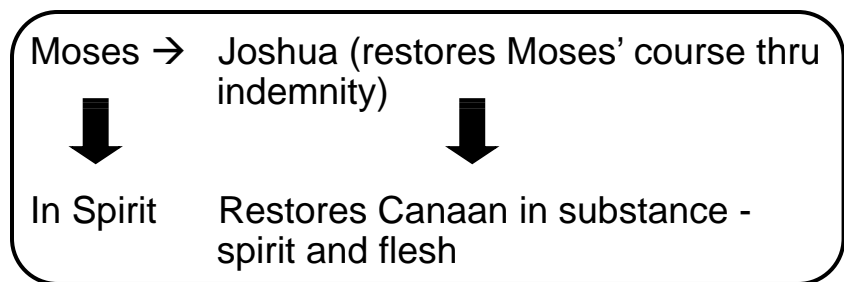

2) Restoration of Canaan

Moses	Joshua (Restores Moses' course thru indemnity)
3-day course → Red Sea	3-day course → Jordan River Shittim (Spying) → Jordan
Guided by pillars of fire, cloud	People guided by the Ark of the Covenant
Red Sea divided by Moses staff	Jordan River divided by the Ark of the Covenant

3) Setting up the Stone Altar at Gilgal (Josh 4:20)

- (1) Twelve stones were taken from the place where the priests' feet stood in the midst of the Jordan River and were then set up as a stone altar in Gilgal.
- (2) Jacob built a stone altar wherever he went... (as an altar of prayer to praise God).
- (3) When Jacob's descendants, the twelve tribes, also set up the altar of twelve stones, this foreshadowed that the twelve tribes would construct the Temple.
- (4) This also foreshadowed that in the future, the twelve disciples would have to join together in unity to honor and relate to Jesus as the actual Temple.
- (5) The Israelites began to produce their own food from the land → God stopped providing them with manna.

4) The Conquest of Jericho

(1) The Israelites marched in obedience to God's command.

40,000 soldiers – 7 priests (ram horn trumpets) - the Ark of the Covenant - the Israelite people

(2) Method

March once a day for six days, then circle the city seven times on the seventh day, then shout.

(3) Foreshadowed that Jesus would come in the future and, with his authority and the work of the saints, would destroy the barrier between heaven and earth that Satan had constructed

5) Joshua Defeated 31 Kings

This foreshadowed that Jesus Christ would come as the King of Kings to bring all the royal families of the earth to a complete surrender and win the hearts of their people, thereby building the unified Kingdom of Heaven on Earth.

V. Lessons

1. A New Understanding of Old Testament History

The Old Testament was previously thought to be nothing more than a historical record about Moses, but:

- Through Moses' course, God teaches us the secrets of the providence of restoration.
- Jesus only hinted at the significance of Moses' course, but was unable to reveal more (John 5:19).
- Moses course directly foreshadows the model course that Jesus was to walk.
- We can be certain that God is real and that He is leading human history towards one absolute purpose.

2. Moses' course shows us that the question of whether God's Will for human beings is predestined and accomplished is decided by the fulfillment of the human portion of responsibility.

3. Greater conditions of indemnity

4. The greater a person's mission is, the greater the trials and the tests that the person will experience.

5. Everything is Decided in an Instant.

The Relationship between each instant and our entire life

6. God puts the person through a test either before or directly after he grants his Grace.

- (1) 40 years in Pharaoh's palace → The first Exodus course
- (2) 40 years in the wilderness of Midian → The second Exodus course
- (3) God seeking to kill Moses → The three miracles and the ten plagues
- (4) 3-day course → The pillars of fire and of cloud
- (5) The Red Sea → Manna and quail
- (6) The Amalekites → The tablets of stone, the Tabernacle, and the Ark of the Covenant
- (7) 40 years in the wilderness → The water from the rock
- (8) The fiery serpents → The bronze serpent

- End -

The Worldwide Course for the Restoration of Canaan Centering on Jesus

Introduction

In the beginning, Adam should have governed the angels (I Cor 6:3) , but due to his fall, human beings came under Satan's dominion and formed a hellish world. To restore this through indemnity, Jesus came as the second Adam to personally bring Satan to submission and establish the Kingdom of Heaven. However, Satan, who does not submit even to God, would by no means readily yield to Jesus and people of faith. Therefore, taking responsibility for having created human beings, God raised up Jacob and Moses and revealed through them the model course by which Jesus could subjugate Satan.

Jacob walked the symbolic course to bring Satan to submission, while Moses walked the image course. Their courses pioneered the way for Jesus to walk the actual course. In walking the worldwide course to restore Canaan, Jesus followed the model demonstrated in the national course to restore Canaan when Moses was working to subjugate Satan.

I. The Foundation for the Messiah

Fallen human beings must be restored to the state in which they were originally created. For this to happen, they must establish a relationship with the Messiah.

To establish a relationship with the Messiah, human beings must first establish the Foundation for the Messiah.

If there is no Foundation for the Messiah, fallen people will kill the Messiah when he comes.

The Foundation of Faith

- i. Central Figure: John the Baptist
- ii. Object for the Condition: The Word
- iii. Time Period: 400 years

The Foundation of Substance

- i. Central Figure: John the Baptist
- ii. Condition: Indemnity Condition to Remove the Fallen Nature

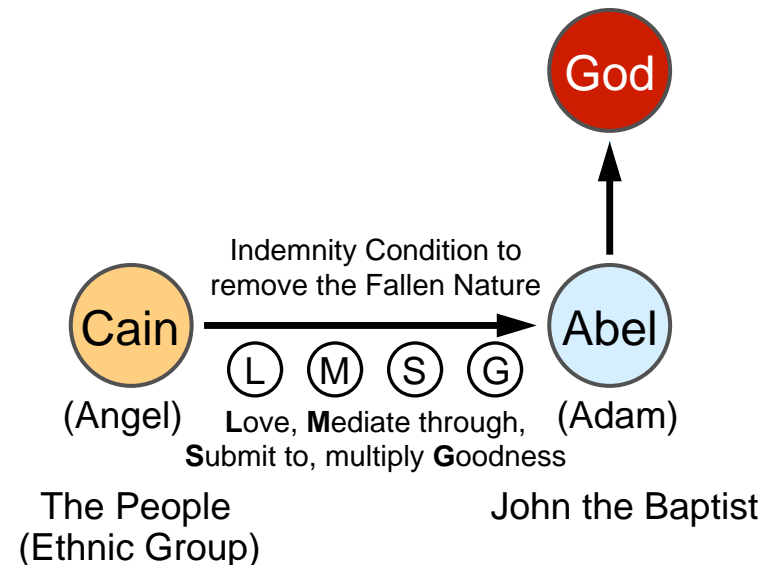

1. The First World-level Course for the Restoration of Canaan

1) The Foundation of Faith

(1) Central figure = John the Baptist

- { The Second Coming of Elijah (Matt 17:13)
- { One who makes straight the way of the Lord (John 1:23)
- { Life of prayer and asceticism in the wilderness

(2) Object for the condition = Oneness with Tabernacle on the foundation of the number 40.

(Messiah came on the 400-year ethnic-group period)

2) The Foundation of Substance

(1) Central figure = John the Baptist

(2) Condition

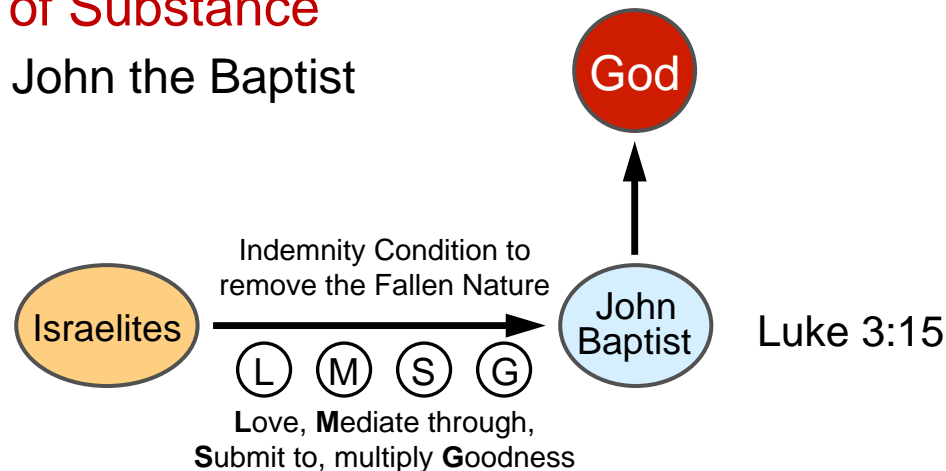

Failed due to John the Baptist's disbelief in Jesus

2. The Second World-level Course for the Restoration of Canaan

1) The foundation of faith

- (1) Central figure: Jesus (who takes on the mission of John the Baptist)
Receives baptism at the Jordan River (John 1:29)
- (2) Object for the condition: 40-day fast and the Three Temptations

❖ The Three Temptations

A. Reasons why Jesus had to face the three temptations

Remote cause: Moses' act of striking the rock twice, breaking the tablets of stone

Immediate cause: Disbelief of John the Baptist (Failure of the Elijah-type central figure)

B. Satan's purpose in tempting Jesus with the three temptations

To cause the purpose of the coming of the Messiah to fail (Purpose of Creation)

Purpose of the Messiah's advent = Purpose of Creation = Three Blessings = Three Temptations

Satan became a subject who could make the Three Temptations
→ Moses' mistake led to Satan claiming ownership over the rock and the tablets of stone.

C. Meaning of the Three Temptations

i. The First Temptation – In the Wilderness

Satan: Stone → Bread

Jesus: Word ← Bread

||

Jesus (Rev 2:17)

Stone = Jesus
Signifies Satan asking Jesus
to give up the position and
role of Messiah

Result: Jesus established the condition of indemnity to restore the First Blessing.
Formed the foundation that restored the position and role of Messiah

ii. The Second Temptation – On the Pinnacle of the Temple

Satan: “If you are the Son of God, throw yourself down.”

Jesus: “You shall not tempt the Lord your God.”

God: Owner without form
Jesus: Owner in substance
Angel: Servant

Result: Jesus established the condition of indemnity
to restore the Second Blessing.
Formed the foundation that restored children

iii. The Third Temptation – On a High Mountain Top

Satan: If you worship me → I will give all things to you.

Jesus: You shall worship and serve only the Lord your God.

Adam fell and bowed down to Satan.

Satan tempted Jesus to become just like fallen Adam.

Result: Jesus established the condition of indemnity to restore the Third Blessing.
Formed the foundation to govern all creation

iv. Through Jesus' Victory Over the Three Temptations:

- Jesus restored through indemnity all the conditions that had been offered in any providential course for the purpose of establishing a foundation of faith.
- Jesus established the condition that would allow him to fulfill the Three Blessings and the restoration of the four position foundation through indemnity.

2) The Foundation of Substance

(1) Central figure = Jesus

(2) Condition

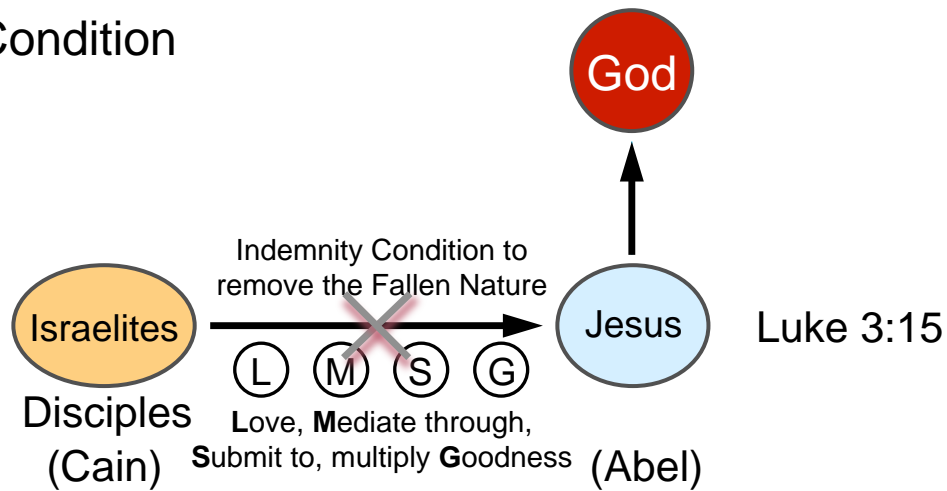

Second Course Failed

3. The Third World-level Course for the Restoration of Canaan

- 1) Jesus came as the substantial, actual tabernacle and temple. When the Jewish people rejected him, and then even his disciples fell into faithlessness, Jesus had no choice but submit his body to crucifixion.
- 2) As a consequence of this, the Jewish people lost their object of faith, both spiritually and physically, and the third world-level course for the restoration of Canaan could not begin as a substantial course.
- 3) As the second Israel, Christian believers re-established the resurrected Jesus as their object of faith, and thus came to begin the third world-level course as a spiritual course.

4. The Spiritual Course for the Restoration of Canaan centering on Jesus

(The Spiritual Foundation for the Messiah)

1) The Spiritual Foundation of Faith

(1) Central figure: Resurrected Jesus (standing in the spiritual position of John the Baptist)

Jesus resurrected after three days (to restore, as his resurrected spiritual self, the position of the spiritual true parent)

(2) Object for the condition: Substance of the resurrected Jesus for 40 days

(3) Period: The 40-day period following Jesus' resurrection

2) The Significance of the Crucifixion

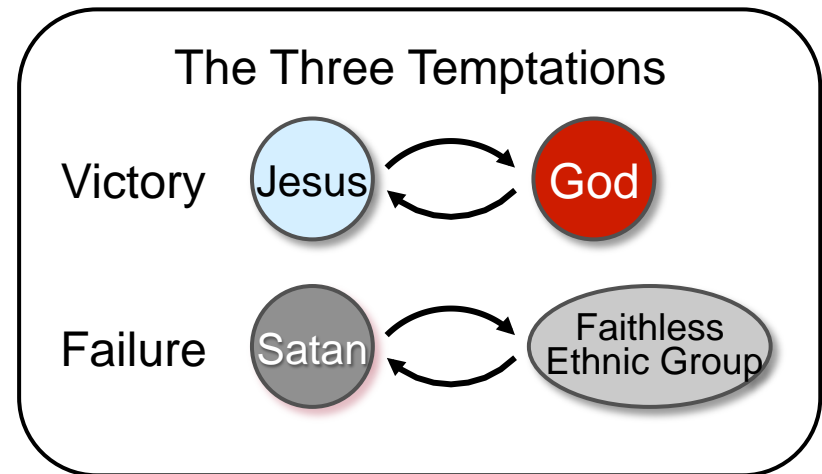
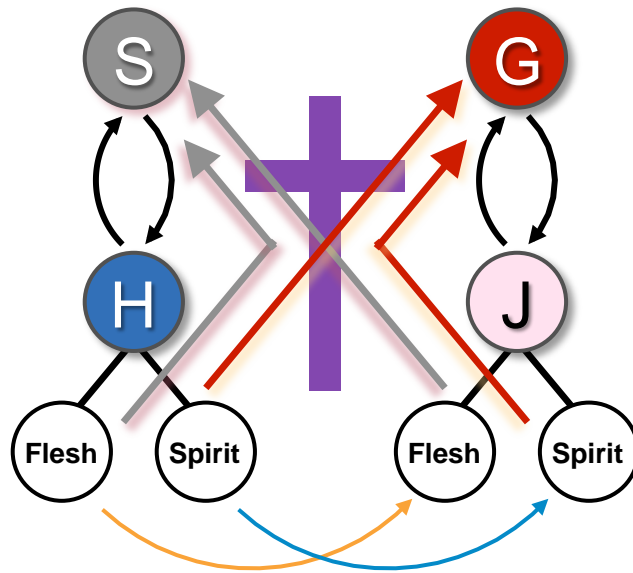

- (1) God's Purpose for sending the Messiah: the salvation of all mankind
- (2) The Purpose of Satan's Claim: Determined to kill Jesus even if it meant handing all of humankind, who was under his claim, over to God.
 - i. In order to rescue humankind who had joined in oneness with Satan, God handed over Jesus to Satan as the price of their sins.
 - ii. Through the exercise of his maximum power, Satan killed Jesus (in order to block the way to physical salvation).
 - iii. In accordance with the laws of restoration through indemnity, God could now exercise his maximum power, and resurrect Jesus (to complete the path to spiritual salvation).

3) The Spiritual Foundation of Substance

(1) Central figure: The Resurrected Jesus

(2) Condition

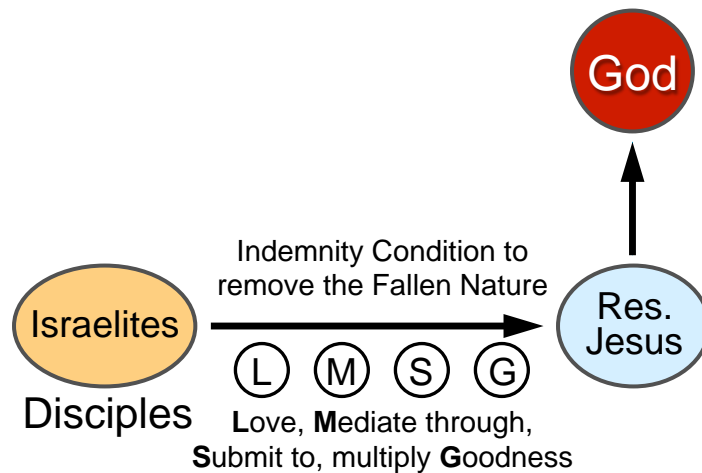

Providence for the Start: Jesus gave his disciples the power to perform signs and miracles.

Spiritual Foundation for the Messiah Successful: The providence for the restoration of Canaan was accomplished, but only spiritually.

5. The Course for the Substantial Restoration of Canaan centering on the Second Coming of Christ

The third world-level course for the restoration of Canaan was begun as a spiritual course. After 2000 years, it has formed the worldwide spiritual foundation that exists today.

1) Foundation of Faith

- (1) Central figure: New John the Baptist (Second Coming of Christ)
- (2) Object for the condition: Condition of faith with the number 40

2) Foundation of Substance

- (1) Central figure: New John the Baptist (Second Coming of Christ)
- (2) Condition

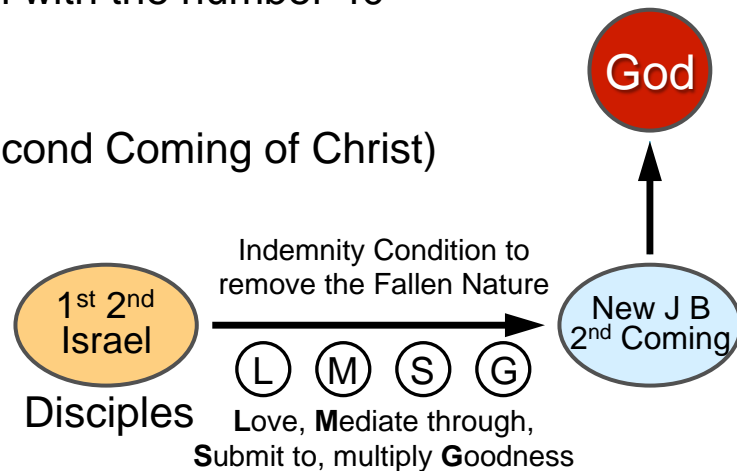

3) The Third Ethnic-group Level Course for the Restoration of Canaan

Moses (spirit) → Joshua (spirit & flesh) substantial course - Restoration of Canaan

4) The Third World-level Course for the Restoration of Canaan

Jesus (spirit) → Second Coming of Christ (spirit & flesh) substantial course - Kingdom of Heaven on Earth

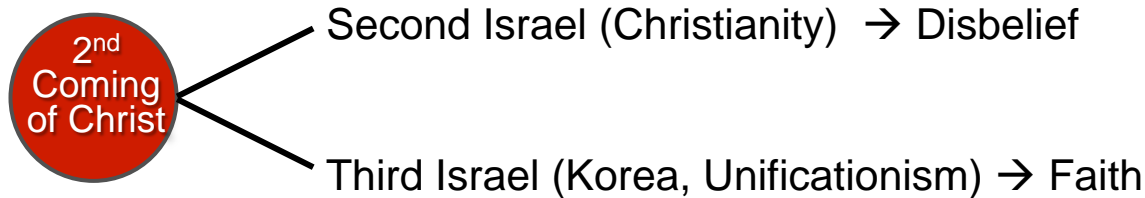
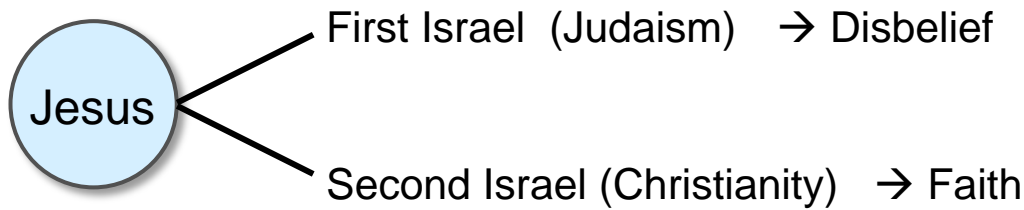

Providence for the Start

Moses	External – Centering on the Rock	Jesus	External – Miracles & signs
↓		↓	
Joshua	Internal – Water from the rock	Christ at the Second Coming	Internal – Centering on the Word

6. Jesus Christ is the Saint of Saints (The Messiah)

1) View of the Providence from the Perspective of Principle (The Providence for the Birth of Jesus)

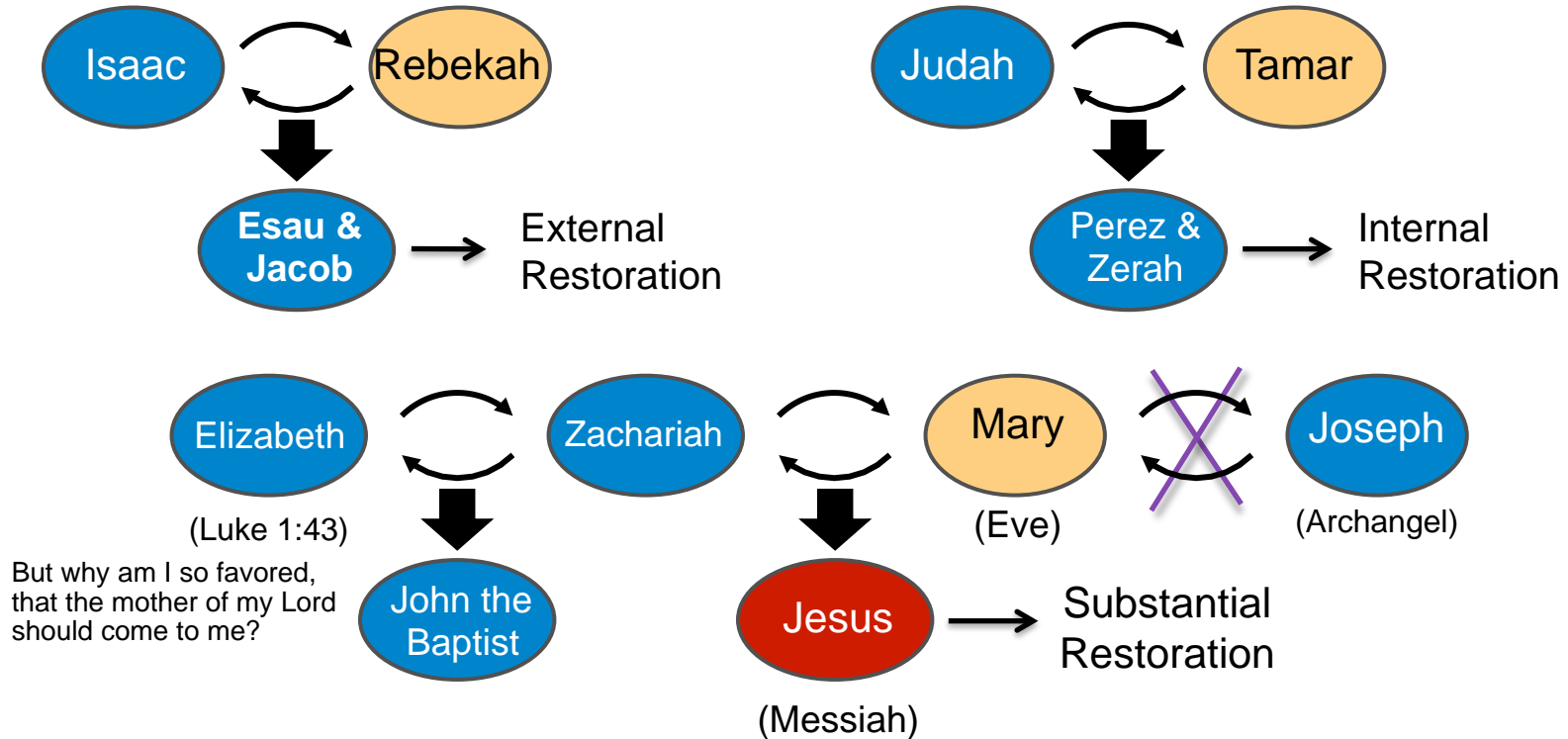

- 2) Jesus lost the substantial foundation that was centered on his spirit and flesh.
 Disbelief by Zachariah's family (Zachariah, Elizabeth, John the Baptist)
 Disbelief by Joseph's family (Joseph, Mary)

Why did they fail to believe in Jesus?

The issues: Jesus' birth, how Jesus was raised, Jesus' marriage

3) Jesus worked to reestablish the spiritual foundation and then begin the providence again (Jesus' public course).

(1) Jesus' departure from home

i. Jesus' lament (**Matthew 8:20**)

"Foxes have dens and birds have nests, but the Son of Man has no place to lay his head."

ii. Wedding feast at Cana (**John 2:4**)

"Woman, why do you involve me?" Jesus replied. "My hour has not yet come."

iii. Jesus' mother and brothers come to find him (**Matthew 12:48**).

He replied to him, "Who is my mother, and who are my brothers?"

(2) Jesus talking with a Samaritan woman (at the well)

(3) The Last Supper and the betrayal of Judas Iscariot (Luke 22:21-22)

(4) Life and Death Struggle in Prayer at the Garden of Gethsemane

"My Father, if it is possible, may this cup be taken from me. Yet not as I will, but as you will" (Matthew 26:39).

The three disciples sleep ----- They lost the spirit and flesh foundation.

(5) Jesus' arrest and trial

i. The trial by Caiaphas

Charge: Are you the Son of God?

ii. The trial by Pilate

Charge: Are you the King of the Jews?

Israel had no legal authority to carry out an execution.

The Governor Pilate ----- declared this man to be innocent.

Barabbas and Jesus ----- asked the crowd, which of these should I release?
(Matthew 27:15-19)

The crowd ----- you must forgive Barabbas and crucify Jesus.

His blood be on us and on our children (Matthew 27:20-26)

iii. Jesus is arrested.

(Jesus) ----- Carries the cross.

(6) Jesus on the cross

i. Jesus words to the women weeping at his crucifixion:

“Do not weep for me; weep for yourselves and for your children.” (Luke 23:26-28)

ii. Jesus’ suffering of the cross

iii. Jesus’ prayer on the cross

- “Father, forgive them, they know not what they do.” (Luke 23:33~34)

- “Eli, Eli, lema sabachthani.” (Matthew 27:45~46)

- “Father, into your hands I commit my spirit.” (Luke 23:46)

iv. Jesus’ death on the cross

4) Jesus' Resurrection Providence

- (1) Jesus' spiritual resurrection ----- Advent of the Holy Spirit at Pentecost (Acts 2:1-4)
- (2) Christianity starts from Jesus and the Holy Spirit.

5) Jesus' Original Mission

- (1) Receive the Holy Wedding Blessing and become the True Parent, then bless all humankind (remove their original sin)
- (2) Establish a true family (complete the purpose of creation)
- (3) Restore and establish God's homeland and nation

6) Jesus' Sorrow

- (1) The path for him to be married was blocked by his mother, whom he loved so dearly.
- (2) Jesus experienced the **deep bitterness** of being unable to leave behind a lineage.
- (3) Jesus experienced the **deep unrequited agony** filled with blood, tears and sweat of having to die on the cross without completing his original mission.

7) Jesus' Painful, Bitter Sorrow and Liberation from his Course of Death

The True Parent revealed to us Jesus' situation.

Offering comfort to Jesus as the True Parent

The Coronation Ceremony crowning Jesus Christ as King

(Jerusalem, December 22, 2003; Washington, February 4, 2004)

(1) In order for Jesus not have to go the way of the Cross....

Messiah { Zachariah's Clan (Cain) } Jesus reigns as Clan Messiah.
(Jesus) { Joseph's Clan (Abel) } John = Feudal Lord under Jesus



Jesus does not need to go the path of the Cross.

(2) What is the path to liberate the sorrow of Jesus and True Parents?

Accomplish the Mission of Tribal (Clan) Messiah
Establish and perfect Hoon Dok Home Church
Establish Restoration of God's Homeland

→

Complete Blessing of Clan (Tribe)
Wolli Boncheron and Absolute Sex Education
Hoon Dok Lifestyle (8 Great Textbooks, True Father's Autobiography)

II. Lessons

1. God's predestination of His Will is absolute; His predestination of human beings is relative.
2. The greater a person's mission, the greater the test he will confront.
 - i. Adam betrayed God – Jesus was abandoned by God to restore this through indemnity.
 - ii. Restoration through indemnity was achieved when Jesus dealt with being abandoned by God (the temptation in the wilderness, the passion of the cross).
3. Jesus loved and died for God and God's will, even while on the Cross.
4. Everything is Decided in an Instant.

The Relationship between each instant and our entire life

Comparison of the Courses of Moses and Jesus

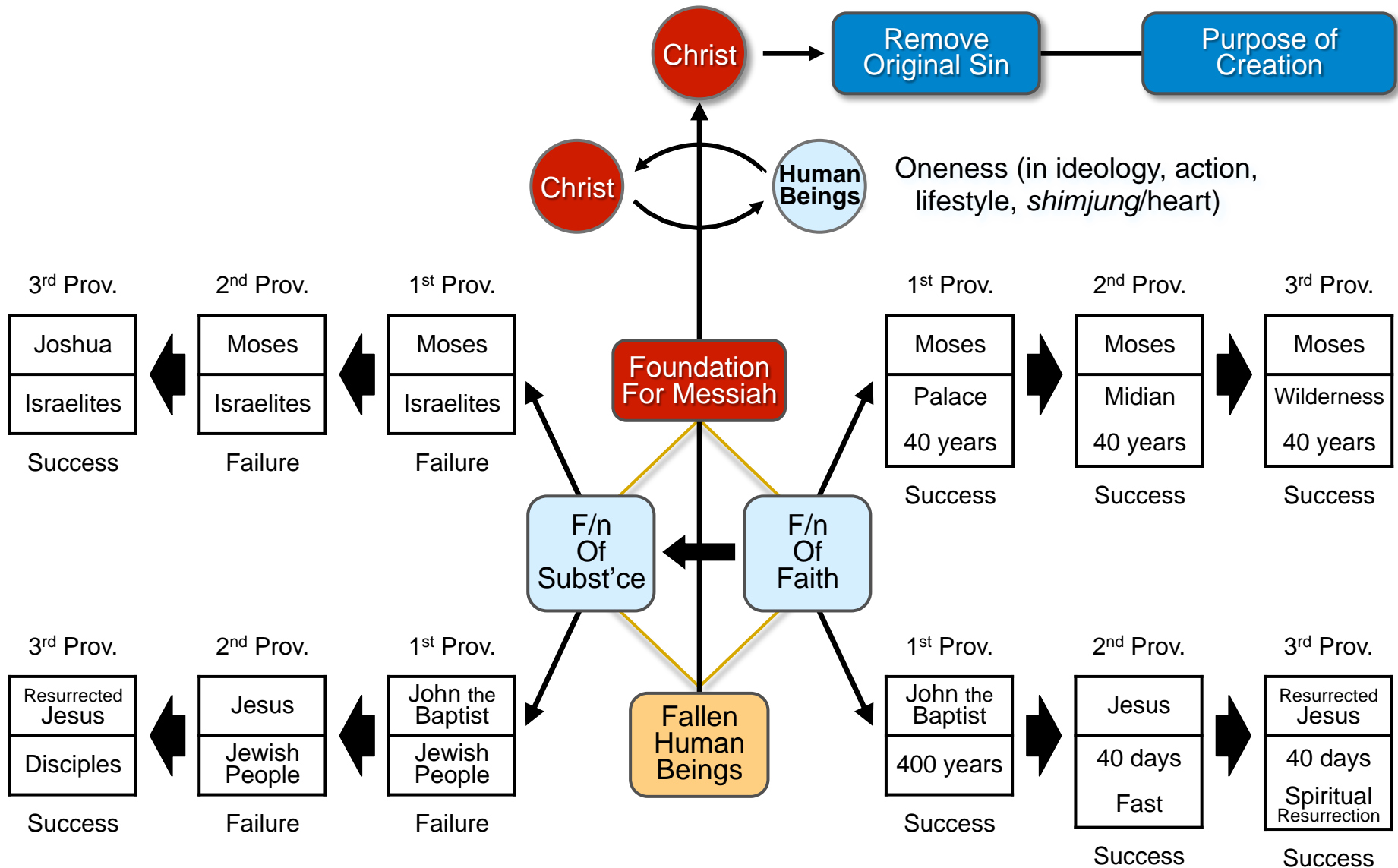

-End-

The Eras in Providential History and the Formation of Their Lengths

Introduction

Is God alive in history?

If God is alive, how does He act or work?

If God indeed acts in history, what laws does he use to carry out his actions?

I. Eras of Providentially Parallel Time Identities

1. What do We Mean by “Parallel Time Identity”?

The historian Arnold Toynbee described historical cycles in which the course of history in an earlier era is repeated in similar form by later eras. Nonetheless, Toynbee was unable to explain why history repeats itself and could not reveal the cause of such parallel time identities.

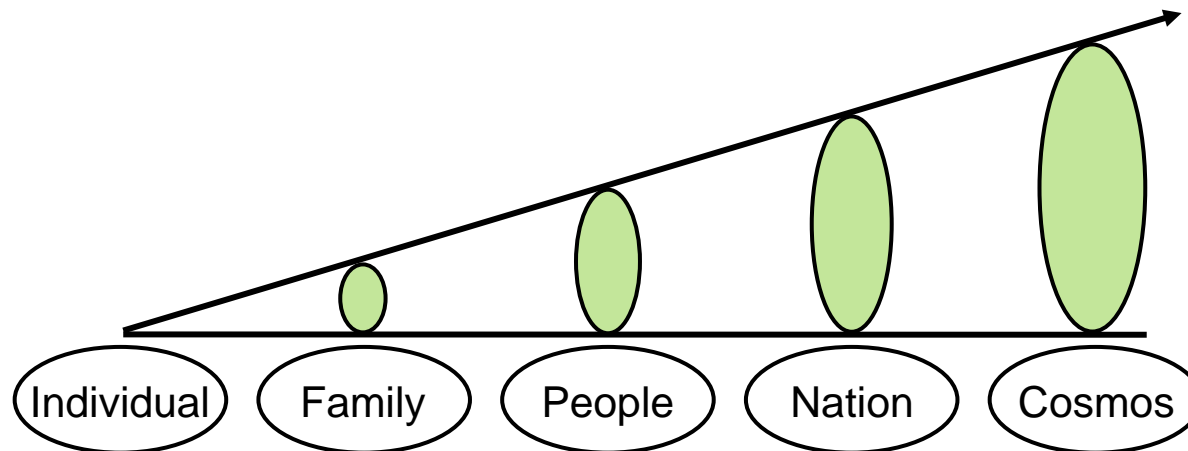

2. Why Parallel Time Identities Occur

1) The Reason That Parallel Time Identities Occur

When a human being fails to fulfill his or her portion of responsibility, that failure must be restored through indemnity. This restoration is why different eras parallel each other.

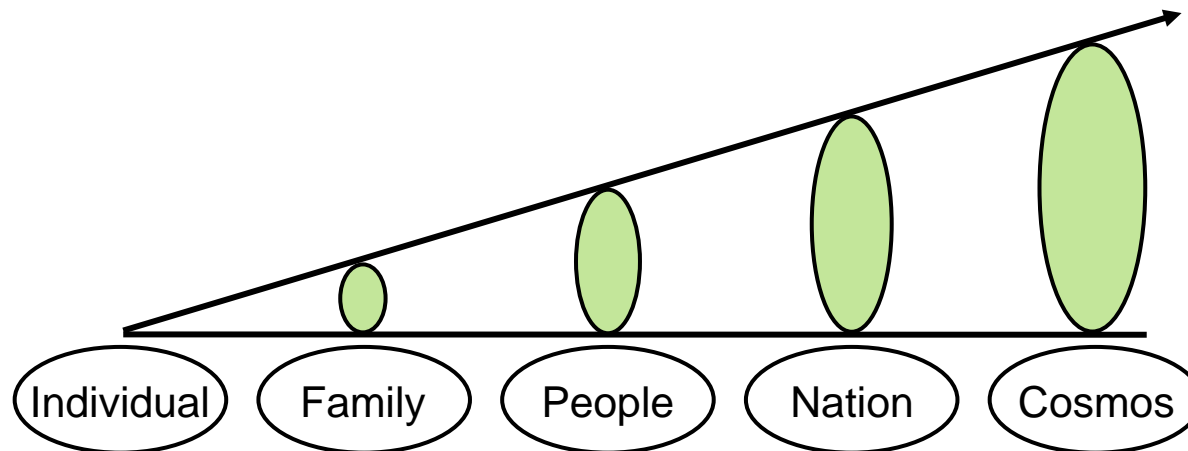

2) Primary Factors Affecting the Formation of Parallel Time Identities

Restoration of the Foundation for the Messiah

(1) Foundation of Faith:
(Separation of good and evil)

- i. Central Figure
- ii. Object for the Condition
- iii. Time Period (Mathematical time period)

(2) Foundation of substance:
(Restoration of Capacity to Govern)

- i. Central figure
- ii. Indemnity condition to remove the fallen nature

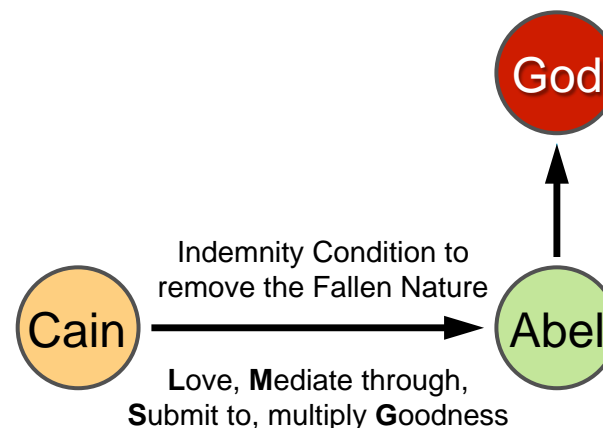

3) Types of the Parallel Time Identities

Formation-stage Parallel Time Identity (in terms of content = Symbolic)

Growth-stage Parallel Time Identity (in terms of content = Image)

Completion-stage Parallel Time Identity (in terms of content = Substantial)

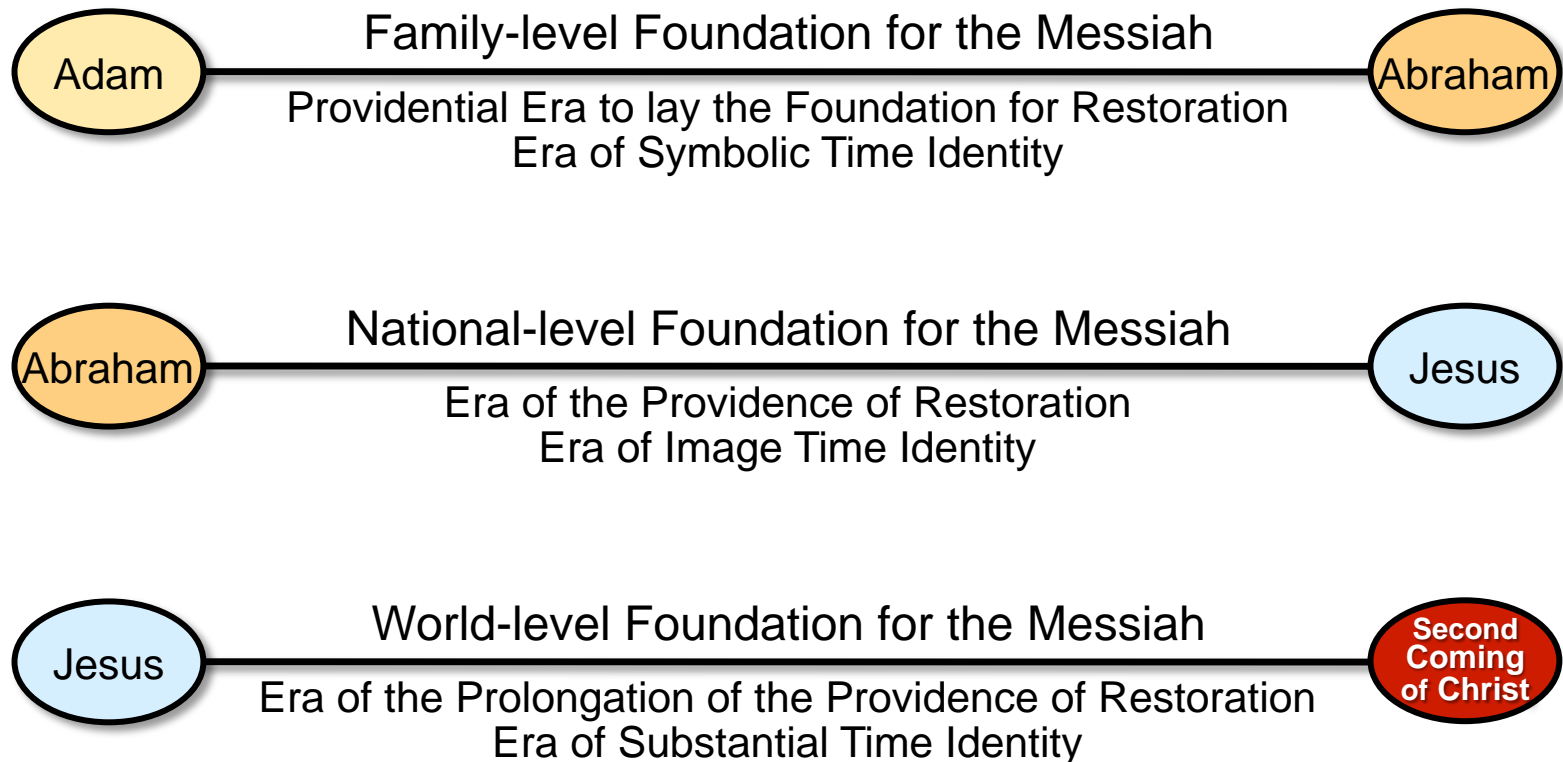

II. The Number of Generations and the Formation of the Number of Years in Each Era of Parallel Time Identity♪

1) Formation of the Number of Years

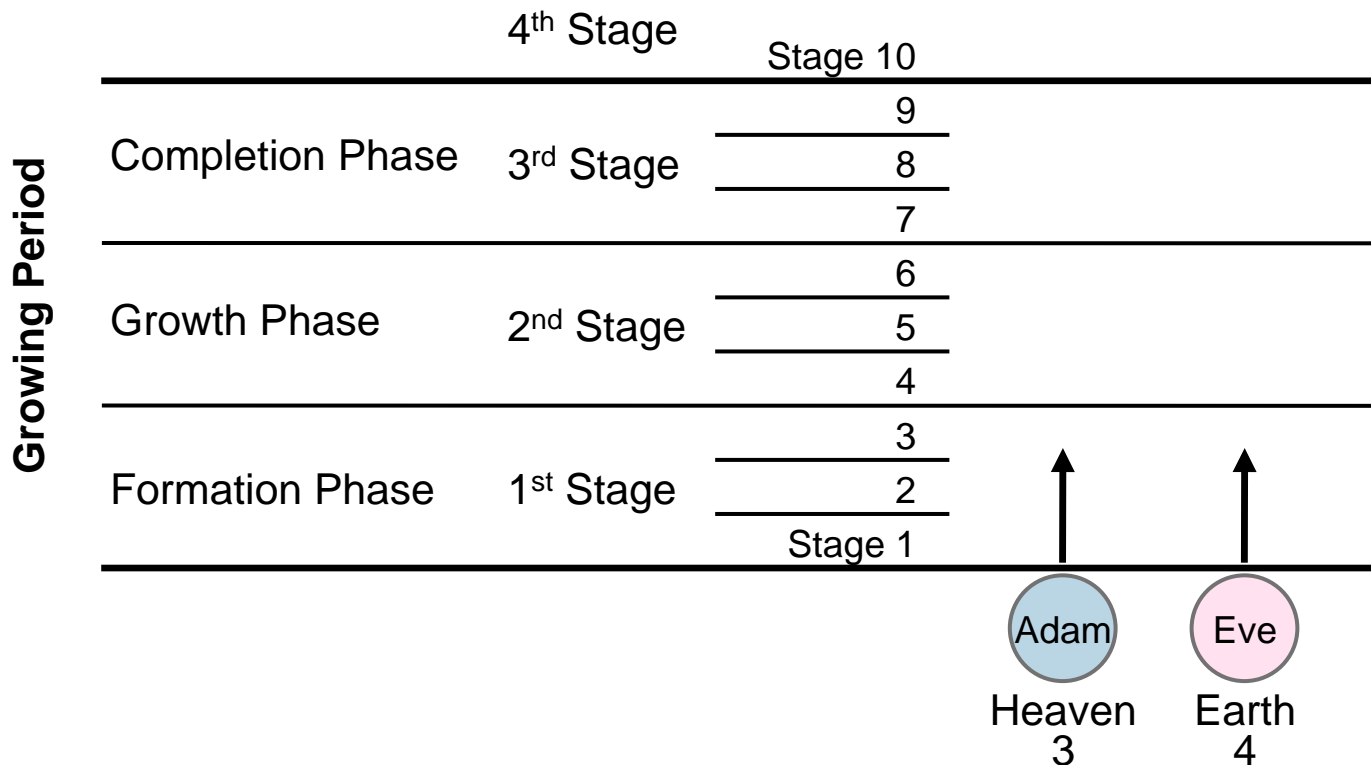

- i. Number 12 = 4 position foundation X 3 stages
- ii. Number 4 = 4 position foundation 4 stages
- iii. Number 21 = 7 Completion No. (Heaven number 3 + Earth number 4) X 3 stages
- iv. Number 40 = 4 position foundation X 10 stages

2) The Number of Years in Each Era of Providential Time Identity

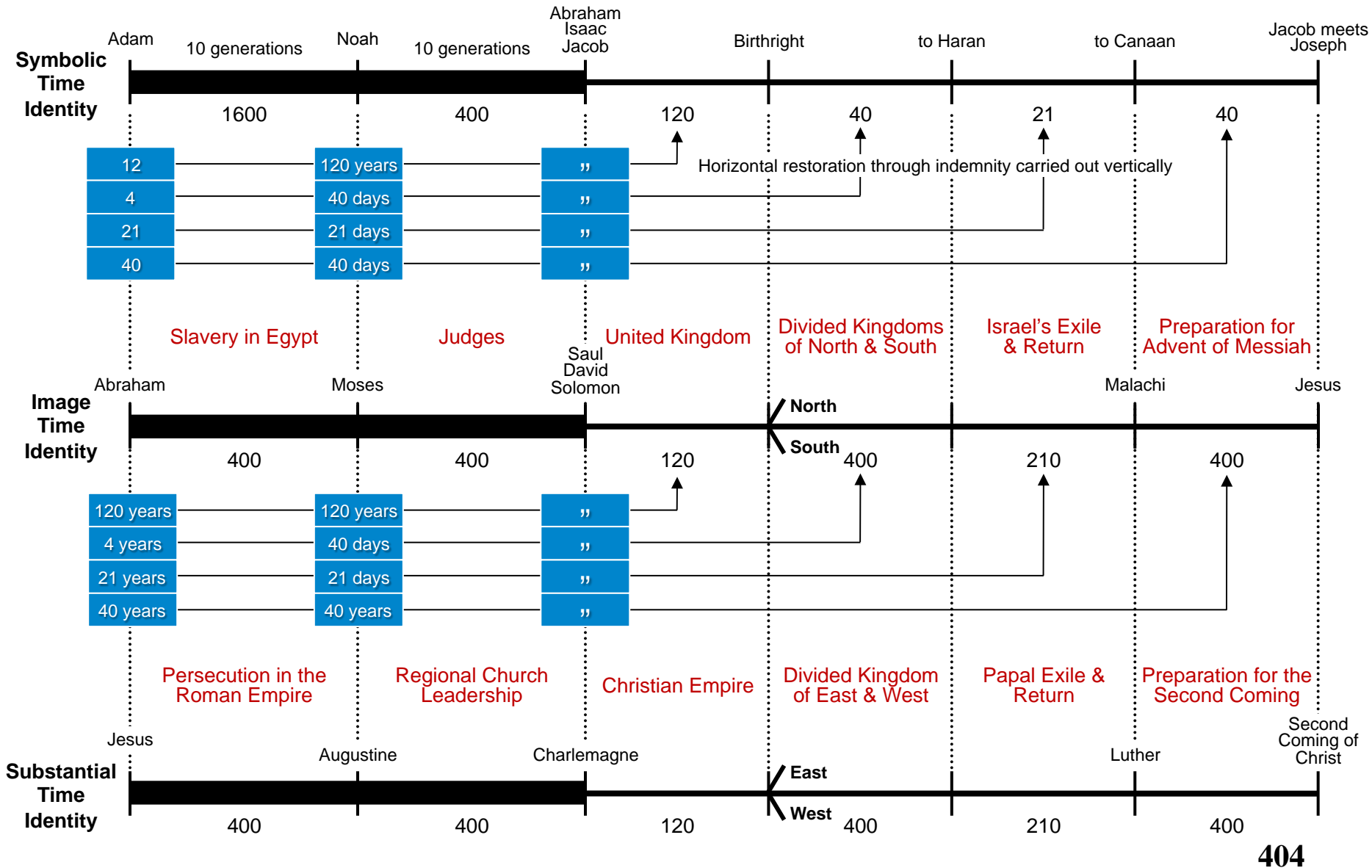

III. The Era of the Providence of Restoration and the Era of the Prolongation of the Providence of Restoration from the Perspective of Providential Parallel Time Identity

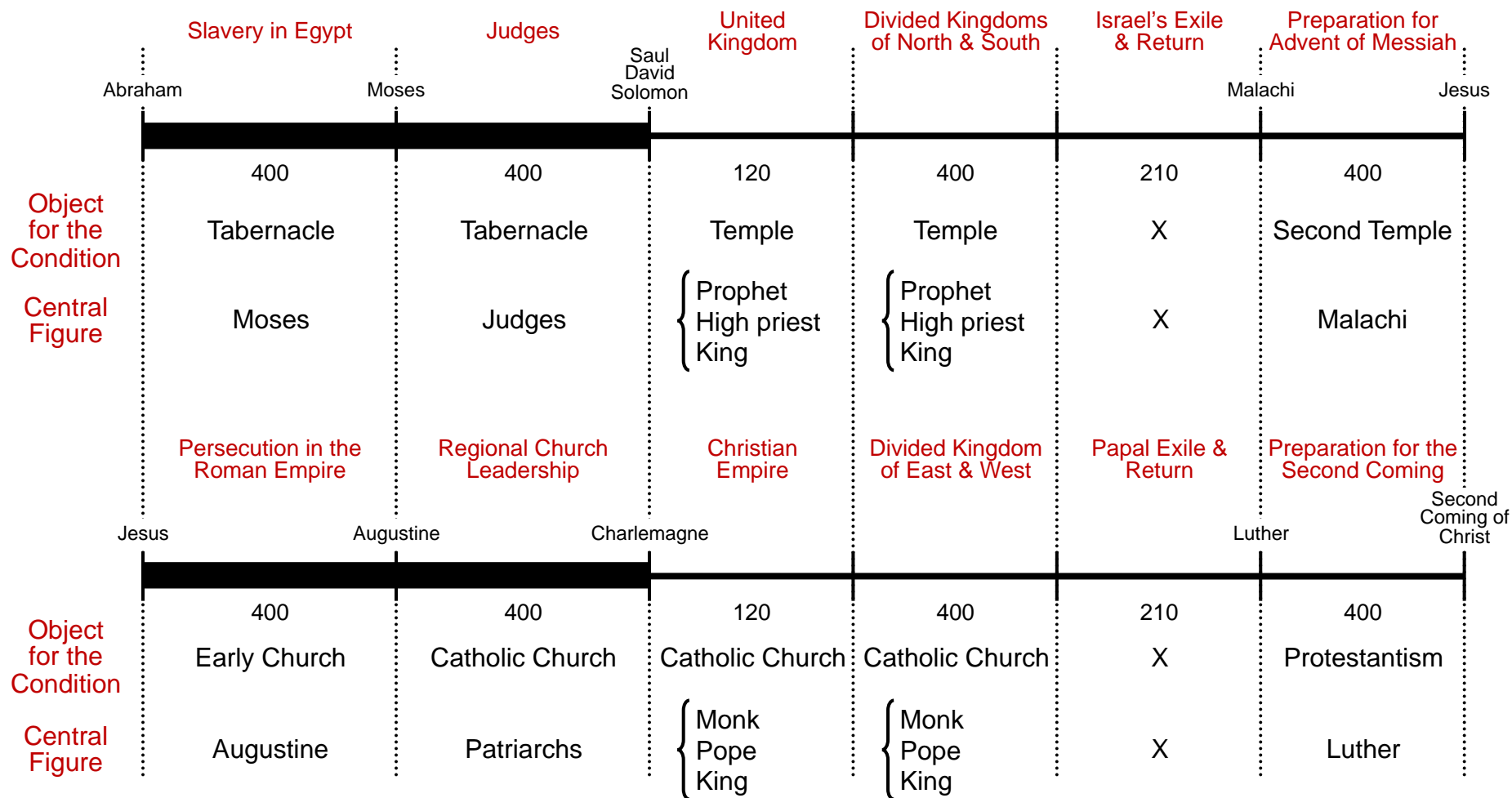

<p>(1) Period of Slavery in Egypt 400 Years</p>	<ul style="list-style-type: none"> i. Abraham's failure in offering → Invasion by Satan – Restoration thru indemnity ii. Jacob's 12 children & 70 kinsmen – Slavery in Egypt (punishment & faith) iii. 1st Israel: Circumcision, sacrifices, Sabbath (Lifestyle for separation from Satan) iv. Moses' 3 miracles & 10 plagues – Surrender of Pharaoh – Exodus v. After the slavery – 10 commandments, core of the Torah – Completion of the Tabernacle – Preparation for the Messiah
<p>Period of persecution under Rome 400 Years</p>	<ul style="list-style-type: none"> i. Jewish people's failure to uphold Jesus as a living offering → Invasion by Satan – Restoration thru indemnity ii. Jesus' 12 disciples & 70 followers – Persecution under Rome (punishment & faith) iii. 2nd Israel: Baptism, martyrdom, Sabbath, holy communion (Lifestyle of separation from Satan) iv. Spiritual miracles & power- AD 313 - Emperor Constantine recognizes Christianity; AD 392 - Emperor Theodosius I designates Christianity as the state religion. v. After the persecution - Gospel, core of the New Testament – Completion of the Church (Formation of Early Church) - Preparation for the Messiah

<p>(2) Period of the Judges 400 Years</p>	<ul style="list-style-type: none"> i. Mission of the Judges: Prophet, Priest, King ii. Israelite people entering Canaan → Land divided amongst the Judges iii. Formed a new chosen ethnic group in the new land centering on the Judges – formed the basis of a Jewish feudal society iv. The Israelites had to exalt God’s will for the Tabernacle in obedience to the guidance of the Judges. Unfortunately, they did not. Instead, they failed to destroy the tribes of Canaan and were influenced by their customs, falling into idol worship → Confusion in the practice of Faith
<p>Period of the Patriarchal System 400 Years</p>	<ul style="list-style-type: none"> i. Mission of the Patriarchs: Monastery, Pope, King ii. Migration of the Germanic people Invasion of Huns (a Mongolian tribe) into Western Europe in the 4th century → Migration of Germanic peoples into Western Europe) – Christianity spread to the Germanic peoples (Gospel spread to the Kingdom of the Franks). iii. God established the Germanic people as a new chosen ethnic group in the new lands of Western Europe – formed the basis of a Christian feudal society iv. The Christians had to exalt God’s will for the Church in accordance with the guidance of the Patriarchs. Unfortunately, they did not. Instead, they were influenced by Germanic paganism → Confusion in the practice of Faith

<p>(3) Period of the Unified Kingdom 120 Years</p>	<ul style="list-style-type: none"> i. Prophet Samuel - anoints Saul - First king of Israel (800 years after Abraham)[†] ii. Ideal of the Tabernacle to the Ideal of the Temple – formation of the Kingdom (Moses ideal of the Tabernacle → Solomon’s Temple and Kingdom) iii. Central figure of the Foundation of Faith – the King (High priest = Spiritual kingdom; King = Substantial kingdom) iv. King Saul Fails in Abel’s position - Foundation of Substance fails (King Saul disobeys God’s commands as conveyed through the Prophet Samuel – fall through sexual immorality)[†] v. King Solomon, the 3rd generation, turns to serving pagan gods brought in by his pagan wives → Division of the Northern and Southern Dynasties (pagan gods: Asralot, Milgom, Gmos, Molok)
<p>Period of the Christian Empire 120 Years</p>	<ul style="list-style-type: none"> i. Pope Leo III - Crowned Charlemagne - First emperor of Christendom (800 AD) ii. Towards the Ideal of The City of God as put forth by St. Augustine – formation of the Christen Empire iii. Central figure of the foundation of faith – the Emperor (Pope - Spiritual Empire; Emperor: Substantial Empire) iv. The Emperor left the position of Abel → Foundation of Substance fails (The Emperors failed to be obedient to God’s Will.) v. Christian empire divides after only 3 generations (Louis II, Charles II) into three kingdoms (two kingdoms) and divides into East and West Franks (Italy being ruled by East Franks).

(4)

Era of the
Divided Kingdom of North and South
400 Years

- i. The United Kingdom - Divided after only three generations
- ii. Cain - 10 tribes - Kingdom of Israel (north) - 260 years - 19 kings
Abel - 2 tribes - Kingdom of Judah (south) – 394 years - 20 kings
Northern Kingdom of Israel
Founded by Jeroboam, who had lived in exile during King Solomon's reign
 - The royal line changed nine times during 260 years; of the 19 kings, none were found to be righteous in the sight of God.
 - God sent the prophet Elijah from the Kingdom of Judah, defeated 850 prophets of Baal and Asherah on Mt. Carmel, fire sent down upon the altar
 - Other prophets sent by God (Elisha, Jonah, Hosea and Amos); the Northern kings did not repent
 - God allowed the Assyrians to destroy the north, disqualified them as the chosen people forever.Southern Kingdom of Judah
Founded by Solomon's son, Rehoboam.
 - The royal line continued unbroken from David to Zedekiah; of the 20 kings who reigned during the 394 years, many were righteous.
 - Following King Josiah, the south was influenced by the northern kingdom and fell into idolatry – the Israelites were taken into exile into Babylon.
- iii. God sent four major and twelve minor prophets to guide the nation – (internal movement for repentance and reform)
- iv. Did not heed the words of the prophets - God allowed them to be attacked by gentile nations (i.e. Egypt, Chaldea, Syria, Assyria, Babylon) (external chastisement).
- v. Collapse of the Israelite monarchical society (due to the kings and people of both north and south being taken into exile)

Era of the
Divided Kin
gdom of E
ast and We
st
400 Years

- i. The Christian empire – Divided after only three generations { East Franks (Italy)
West Franks
- ii. Cain - West Franks
Abel - East Franks (+ Italy): Under Otto I → Holy Roman Empire
- iii. Papacy became corrupt - God sent prominent monks to admonish the papacy (Thomas Aquinas, Francis of Assisi) - (movement for internal reform)↑
- iv. Papacy / Church did not heed God's warnings – God allowed them to be attacked by external peoples → external chastisement

The Crusades: When Jerusalem and the Holy Land were under the protection of the Abbasid Caliphate, Christian pilgrims were treated hospitably – after occupation by the Seljuk Turks, pilgrims were abused. - Outraged, successive popes raised the Crusades to recover the Holy Land.

Starting from 1096, **seven crusades were initiated** over a period of 200 years, but they continually resulted in defeat.

- v. Collapse of the Christian Monarchical Society

The papacy completely loses its authority and faith – **loss of sense of national spirit by the common people**

The mainstay of the feudal society – the lords and knights - were decimated by war – **loss of political base**

Repeated defeat in the wars – massive cost of the wars exhausted – **the society fell into economic poverty**

<p>(5) Period of Israel's Captivity and Return 210 Years</p>	<p>i. King Nebuchadnezzar of Babylon takes the royal house of King Jehoiachin, the prophet Daniel and the Israelite people into captivity - 70 years</p> <p>ii. Persia destroys Babylon Royal decree by King Cyrus 3 Popes cause massive confusion (division) 1309 – loss of all authority – recovered in 1449)</p> <p style="text-align: center;"> { Israelites return to their homeland in three waves Established basis of a renewed faith in God } - 140 years </p>
<p>Period of Papal Captivity and Return 210 Years</p>	<p>i. After Pope Clement V - Captive in Avignon, France - 70 years</p> <p>ii. In 1377, Pope Gregory XI - Returns the papal residence to Rome – 140 years Cardinals elect Urban VI (Archbishop of Bari, Italy) as Pope; French cardinals who felt ostracized elected Clement VII as pope and set up another papacy in Avignon, South France.</p> <p>Cardinals in Pisa later rejected these two popes and established Alexander V as the true pope – the two other popes refused to comply, resulting in three different popes reigning simultaneously.</p> <p>At the Council of Constance, bishops, archbishops, theologians and other delegates deposed or led all three popes to abdicate and elected Martin V as the new pope.</p> <p>3 Popes cause massive confusion (division), 1309 – loss of all authority – recovered in 1449)</p> <p style="text-align: center;"> { Exclusive papal authority recovered Established basis for a renewed faith } - 140 years </p>

<p>(6) Period of Preparation for the Coming of the Messiah 400 Years</p>	<ul style="list-style-type: none"> i. 40-day providence for separation from Satan – Final restoration through indemnity (4000 yrs) ii. Rebuilding the Temple, repentance, study of the Torah – raised a movement for reformation of faith – restoration of the Foundation of Faith <ul style="list-style-type: none"> Israelites { Rebuilt the temple destroyed by Nebuchadnezzar } Study of the Torah { Malachi - repentance for past worship of pagan gods } iii. Until they meet with Jesus – a path of external suffering (Persia, Greece, Egypt) (Until leaving to meet with Joseph, Jacob’s family - Suffering) iv. Reformation of Judaic faith, preparation as a chosen people who can receive the Messiah (BC 430 Malachi) <ul style="list-style-type: none"> Historical background and preparation of the environment for Christ (among the gentile peoples of the same era) <ul style="list-style-type: none"> { Buddha (565-485 BC, India) - establishment of Buddhism { Socrates (470-399 BC, Greece) - development of Hellenistic culture { Confucius (552-479 BC, China) - Confucianism (establishment of ethics and morality) v. Jesus – Israel – Rome – to the whole world
--	--

<p>Period of Preparation for the 2nd Coming of the Messiah 400 Years</p>	<ul style="list-style-type: none"> i. 40-day providence for separation from Satan – Final restoration through indemnity (4000 yrs) ii. Religious reformation, repentance, study of the Gospel - Pioneering the path of practicing faith - restoration of the Foundation of Faith After the Pope returned to Rome, medieval Christians <div style="display: flex; align-items: center; justify-content: center;"> <div style="display: flex; align-items: center;"> <p style="margin-right: 10px;">Luther</p> <div style="display: flex; align-items: center;"> <div style="font-size: 2em; margin-right: 5px;">{</div> <div style="margin-right: 5px;">Movement for religious reformation</div> <div style="font-size: 2em; margin-right: 5px;">}</div> </div> <div style="margin-right: 10px;">}</div> <div style="margin-right: 10px;">Following light of the Gospel</div> <div style="font-size: 2em; margin-right: 5px;">}</div> </div> <div style="margin-left: 10px; vertical-align: middle;"> <p>Pioneer & develop faith</p> </div> </div> iii. Until the Second Coming of Christ - path of internal suffering (Humanism, Enlightenment) iv. Renaissance – politics, economy, culture, science - Rapid development → maturation of an environment that can receive the Second Coming v. The Second Coming of Christ – the 3rd Israel – USA – World
--	---

IV. Crossovers of God's Sovereignty and Satan's Sovereignty in Restorational History

Cain-type View of Life
Humanism (Hellenism)

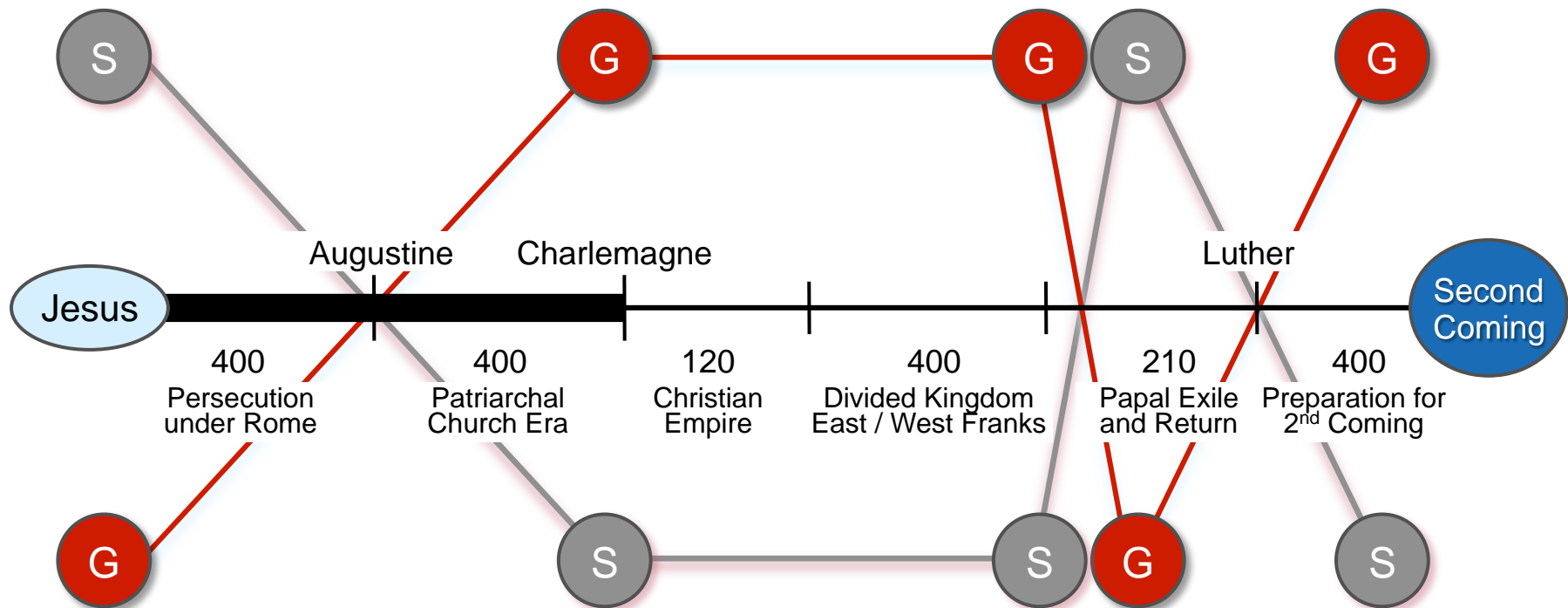

Abel-type View of Life
Godism (Hebraism)

V. Development of History of the Eras of the Providence of Restoration

1. Development of History from the Perspective of the Providence of Restoration

1) The Kingdom of Heaven on Earth - a world similar to a single perfected human being

Ideal of Creation World → world similar to a single perfected person

Fallen World → world resembling a single fallen person

Accordingly, by observing the life practices of a single fallen person we can understand the overall contents of human history.

2) Fallen human beings are the womb of both good and evil

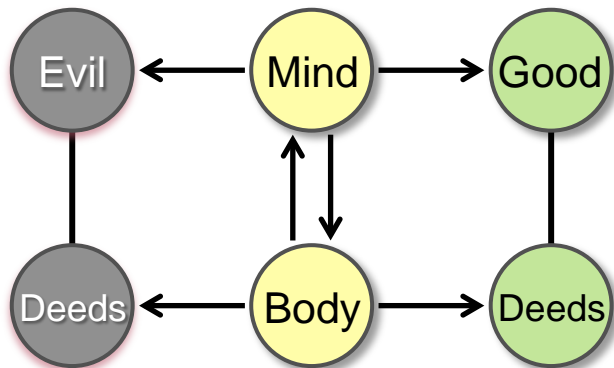

The two minds are always fighting and in conflict within the one body. Individual (fight between spirit and flesh) – Couples (family) – Nations – Global Conflict

Human history = the struggle between good and evil – separation of good and evil – directed towards the purpose of goodness

The original mind is always at work, even in fallen human beings; it directs itself towards the purpose of goodness in accordance with God's providence of restoration.

Accordingly, even if war or conflict results in a momentary victory for evil, history continues to eventually change towards the providential course directed towards the purpose of goodness.

3) Fallen human beings have a blood relationship (kinship) with Satan.

(1) Because human beings fell and formed a blood relationship (kinship, blood ties) with Satan, Satan took the lead to establish an unprincipled world centering on fallen human beings before God could establish his ideal. The unprincipled world that Satan established is similar in form to the principled world God intended to establish.

Accordingly, in the course of the providence of restoration, that which is false appears before that which is true in the form and shape of that which is true. This is why the Bible prophesies that before Christ returns, an anti-Christ would appear.

In the Last Days, at the end of human history, the world of communism emerged in accordance with this principle.

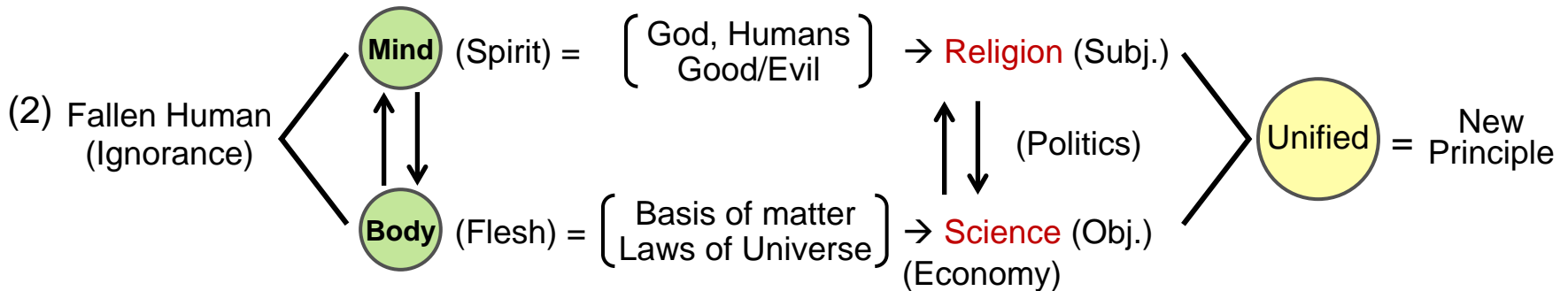

(3) The new expression of truth is the Unification Principle revealed by the Second Coming of Christ, the True Parent. Centering on the Unification Principle, religion, politics and economics must work together under one ideological framework to realize God's ideal of creation.

2. Development of History in the Era of the Providence of Restoration

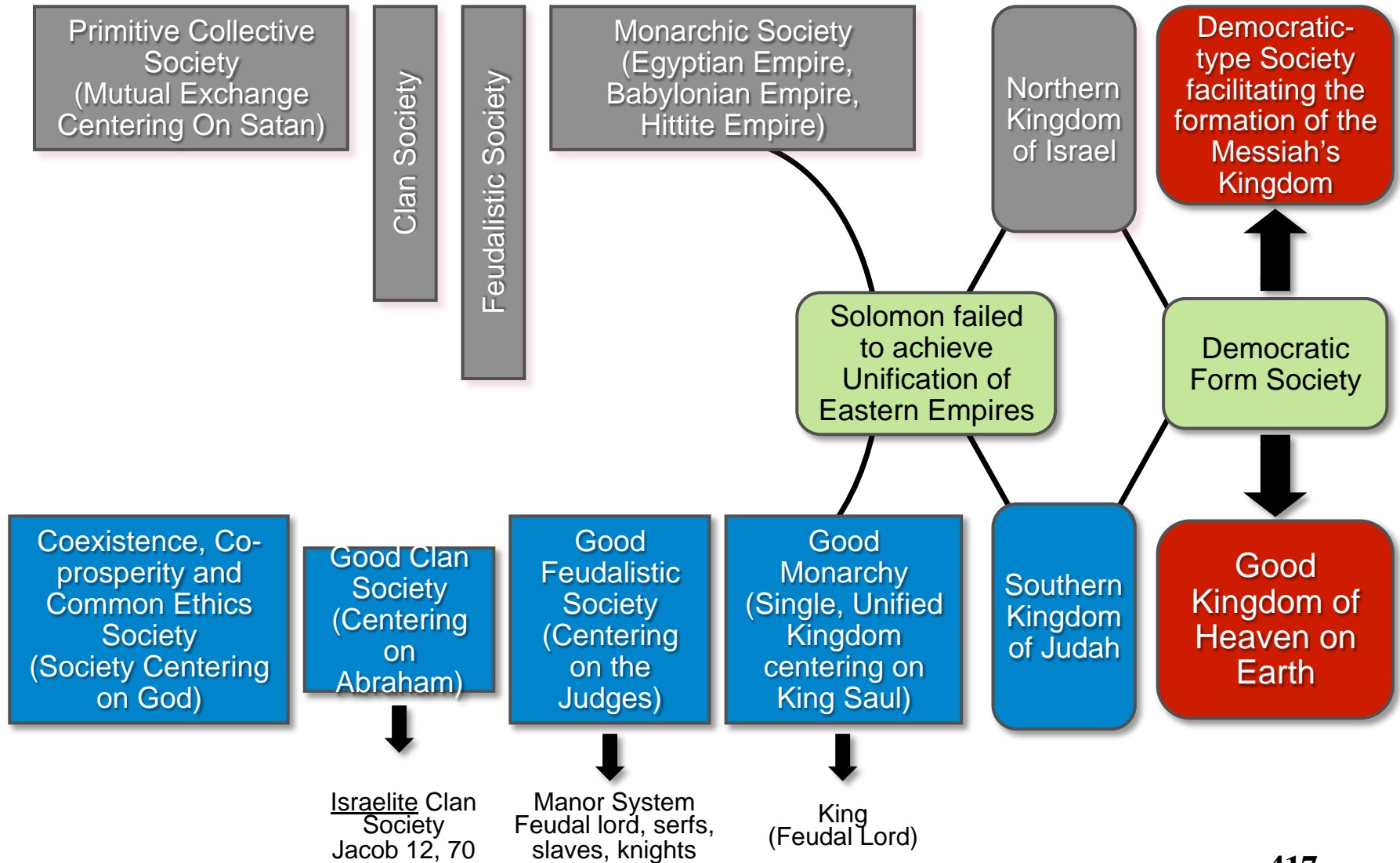

3. Development of History in the Era of the Prolongation of Restoration

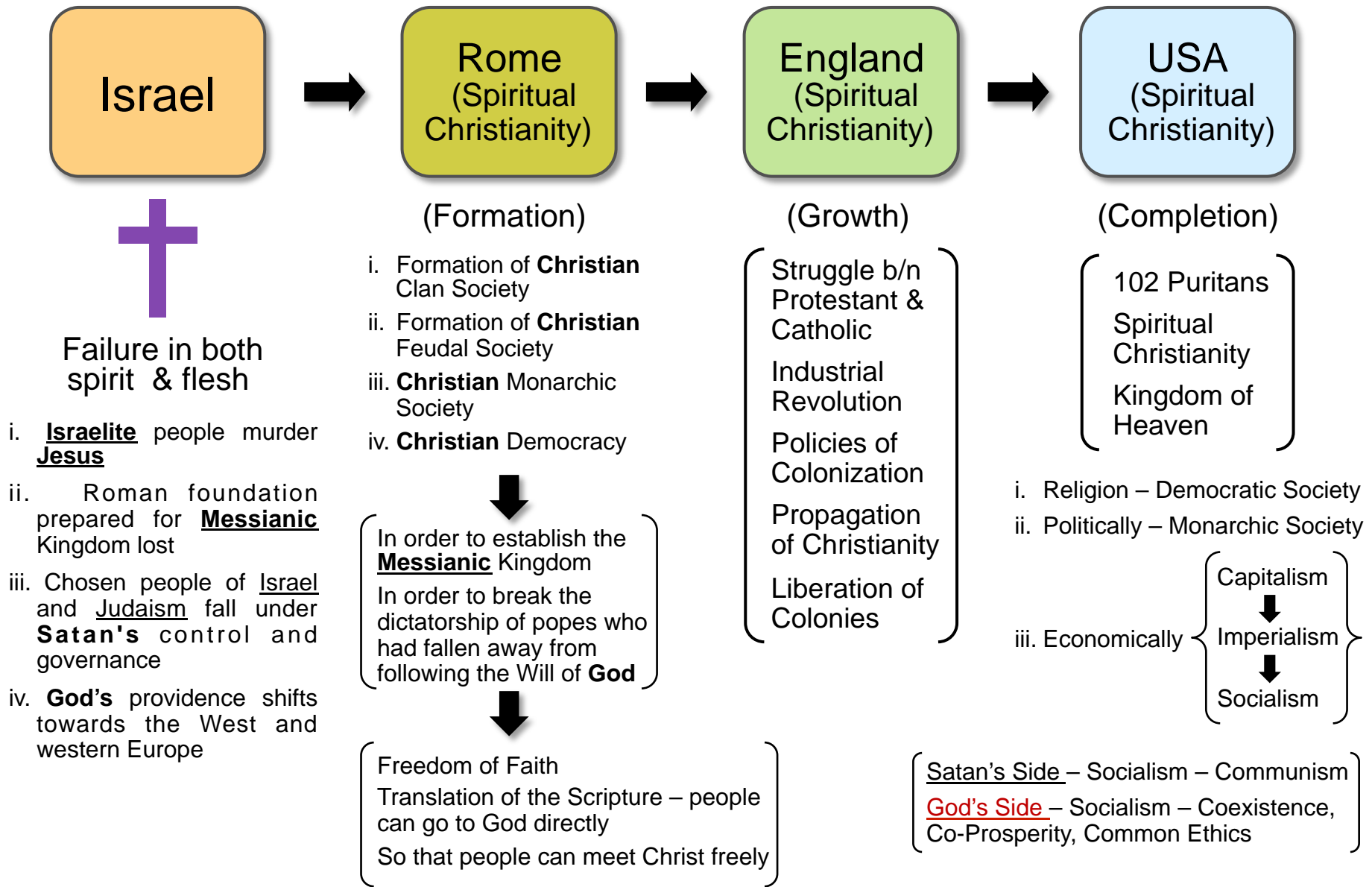

Society of the Ideal of Creation (*Cheon Il Guk*)

Godism (Head Wing Thought)
Coexistence, Co-prosperity, Common Values
(*kong saeng, kong yeong, kong eui*)



{
Abundant Production, as required
Fair and just distribution
Reasonable and rational
consumption
}



(Distribution)



{
Overcoming egotistical selfishness
Guaranteed human rights and
opportunity
Shared authority and reputation
}



(Governance)



{
Absolute value standard (absolute
sex)
Ethical and moral society
World of the culture of shimjung
}



(Heart)
(*shimjung*)

The Period of Preparation for the Second Coming of Christ

Introduction

The Period of Preparation for the Second Coming of Christ

1) Period: 1517-1918 (400 years)

2) Divided into three periods

(1) The Period of the Reformation

1517-1648 (130 years)

(2) The Period of Religious and Ideological Conflicts

1648-1789 (140 years)

(3) The Period of Maturation of Politics, Economy and Ideology

1789-1918 (130 years)

1. The Period of the Reformation

1) Overview

- 1) Period: 130 year period starting in 1517 when Martin Luther raised the banner of the Protestant Reformation in Germany until the Catholic/Protestant wars were settled by the Treaty of Westphalia in 1648
- 2) The Character of the Period
Shaped by the Renaissance and by the Reformation, both products of medieval feudal society
- 3) Reasons for the emergence of the Reformation and the Renaissance

Causes of
Emergence

Medieval feudalism
Secularization of the
Roman church

Rebellion against repression
of the original human nature

Desires of the
Original
Human Nature

External → Movement for the revival of Hellenism → Renaissance
Internal → Movement for the revival of Hebraism → Reformation

2) The Renaissance

- (1) The Renaissance began in 14th Century Italy
(Center of the study of the classical Hellenic thought)
- (2) Movement to revive the classical culture Greece and Rome → Movement that transformed the medieval way of life
- (3) Aside from culture – became a movement that revolutionized all aspects of society, including politics, economic life and religion
The Renaissance became the external driving force that formed modern society.

3) The Reformation

- (1) Cause of the Reformation found in the secularization and corruption of the papacy and priesthood
(Rebellion against the formality and ritualism of the Church, stimulated by the Renaissance)
- (2) Germinated as a movement to restore the spirit of early Christianity
- (3) In 1517, opposition arose to the selling of indulgences by Pope Leo X. This opposition, centered on Martin Luther, ignited the Protestant Reformation.
- (4) International wars between the Catholics and Protestants continued for some 100 years, eventually culminating in the Thirty Years War fought on German soil. In 1648, the Treaty of Westphalia brought the Thirty Years War to a conclusion.

2. The Period of Religious and Ideological Conflict

1) Overview

- (1) Period: The 140 year period starting with the success of the Protestant movement at the Treaty of Westphalia in 1648 and ending with the French Revolution in 1789
- (2) The Reformation and the Renaissance together ushered in freedom for the internal and external aspects of the original nature of human beings.
- (3) Medieval societies encountered ideological disputes and division arising from their freedom in faith and thought.
(theological struggle, doctrinal division, philosophical conflict)
- (4) God unfolded his providence of restoration through a history of dividing Abel-type and Cain-type groups and peoples → In the Last Days of human history, the world itself will be divided into an Abel-type world and a Cain-type world.

2) The Cain-type View of Life (Humanism)

- (1) The external pursuit of original human nature gave rise to a movement to revive Hellenistic thought which in turn gave birth to humanism.
- (2) Medieval society came to judge all aspects of human life through either reason (Rationalism; Descartes) or empirical observation (Empiricism; Bacon).
- (3) These two trends gave birth to a view of life which blocked human beings from pursuing a relationship with God through their internal inclinations and instead opened up the path for them to gravitate towards Satan by actively pursuing their external inclinations.
- (4) As a result, both nature and human beings came to be increasingly separated from God.
- (5) The Cain-type view of life led medieval people in a direction that separated them from or made them independent of God and the practice of faith.
- (6) Figures who historically represented the Cain-type view of life (Strauss, Feuerbach, Hegel, Marx, Engels, Lenin, Stalin, Mao Zedong)
- (7) The Cain-type view of life fused together the atheism and materialism which emerged following the Renaissance and developed through the Enlightenment and finally matured into Marxism, the cornerstone of the communist world of today.

3) The Abel-type View of Life (Godism)

- (1) The original human nature of medieval people not only drove them to focus on external aspects, but eventually led them to include more internal aspects as well.
- (2) As their original human nature led them to pursue those internal values, a movement to revive Hebraism arose. This movement culminated in the Protestant Reformation.
- (3) The Abel-type view of life stimulated modern man to seek God in a deeper and more profound way.
- (4) Figures who historically represented the Abel-type view of life:
Kant, J. G. Fichte, Friedrich Schelling
- (5) $\left\{ \begin{array}{l} \text{Cain-type world (Communism)} \\ \text{Abel-type world (Democracy)} \end{array} \right\}$ In order that human beings could form these two worlds, the two different views of life underpinning them had to be established.

Conclusion

Humanity's View of Life: One of these two views will prevail

3. The Period of Maturation of Politics, Economy and Ideology

This period lasted for 130 years, starting from the time of the French Revolution and the Industrial Revolution in England until the end of the First World War (1789-1918).

1) The Maturation of Politics

(1) Democracy

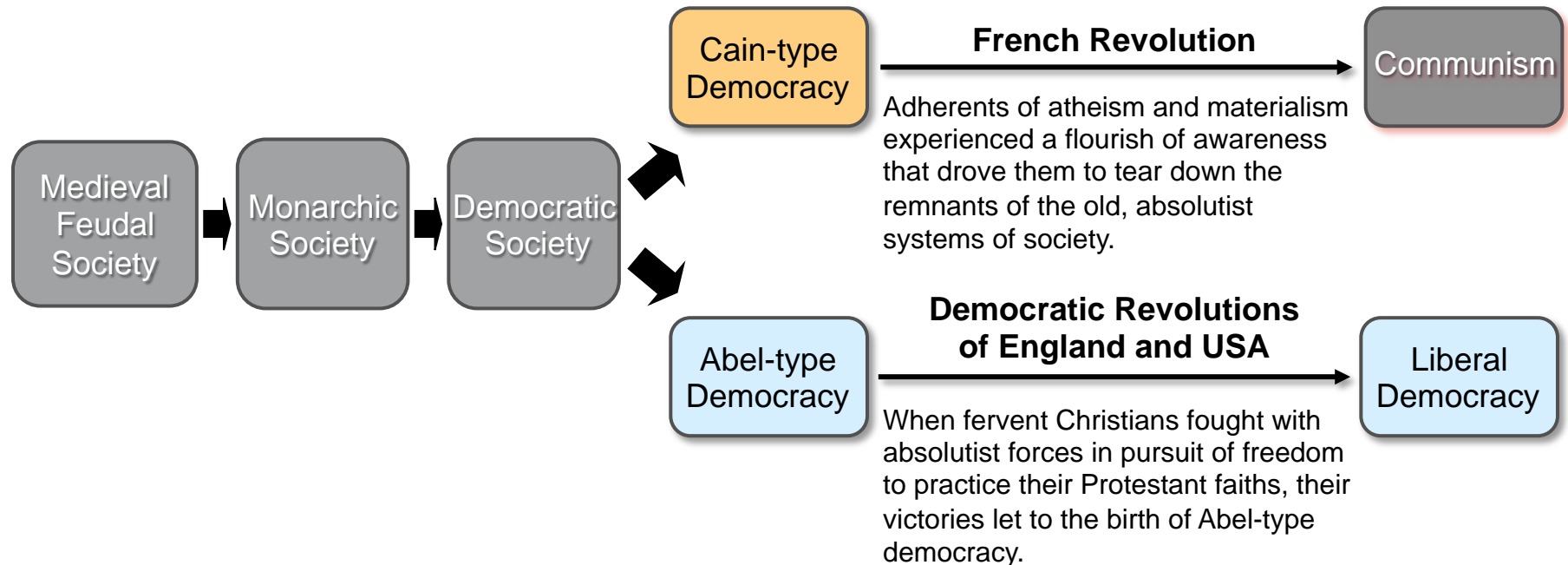

(2) Separation of the Three Powers

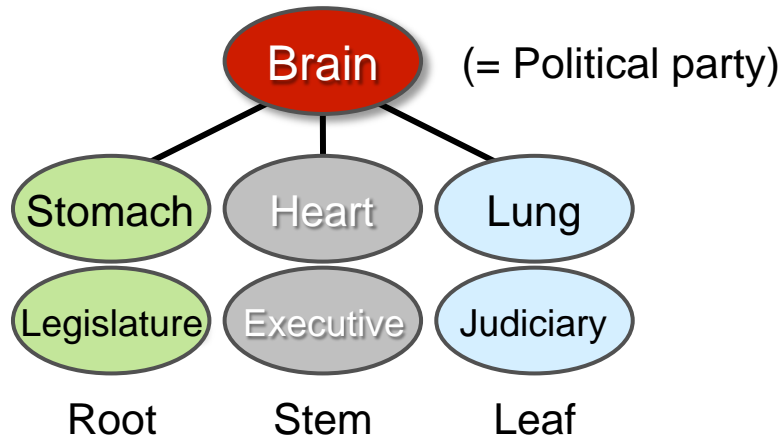

- i. Satan's Side: achieves an unprincipled version of the principle form ahead of God's realization
- ii. Principle of Creation: the created universe is patterned after the structure of a perfected human being.
- iii. Structure of the ideal society → similar to the structure of the human body
 - { Human Body: Brain → Spinal Cord → Peripheral Nervous System → Entire Body
 - { Ideal Society: God → Christ → Believers (Stomach, Heart, Lung) → Economic Structures
 - { Entire Body: Vertical Relationship with Brain → Horizontal Relationships
 - Members of Society: Vertical Relationship with God → Horizontal Relationships
- iv. Process of Restoration:
 - Sole King (Political Party with Three Powers) → King (Three Powers) + Church (as Political Party) → Political Parties with Separation of Three Powers → Ideal Society restored centering on God's Word
- v. Ideal society realized according to the law of the three stages of development
- vi. **Ideal of Cheon Il Guk: Division of the Three Powers → Separation of Five Powers (Legislature, Executive, Judiciary, Finances, Media)**

2) The Maturation of Economy

(1) The Significance of the Industrial Revolution

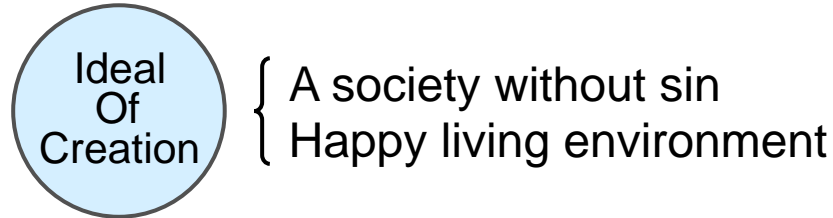

The Industrial Revolution that began in England arose in order to restore a living environment suitable for an ideal society.

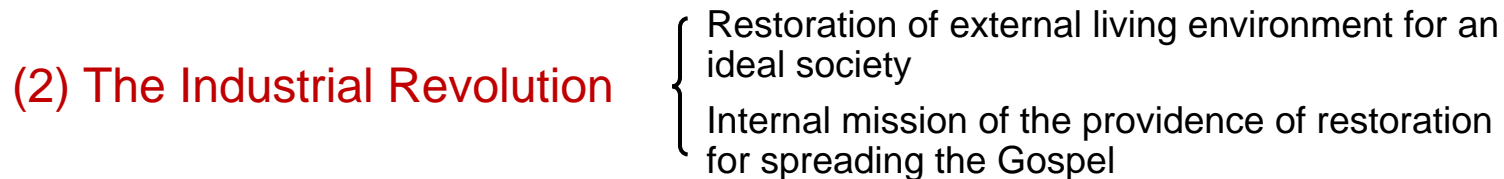

(3) The Rise of the Great Powers and Division of the Colonies

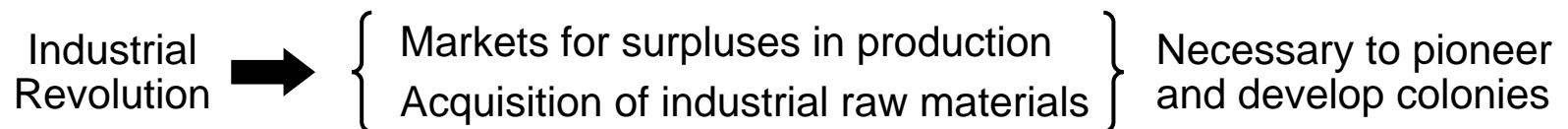

Consequently, the great powers rapidly increased in strength as they competed with each other in the scramble for colonies.

(4) The Ideal World Resembles the Structure of a Perfected Human

Ideal of Creation Realize a world without sin
Restore a happy living environment

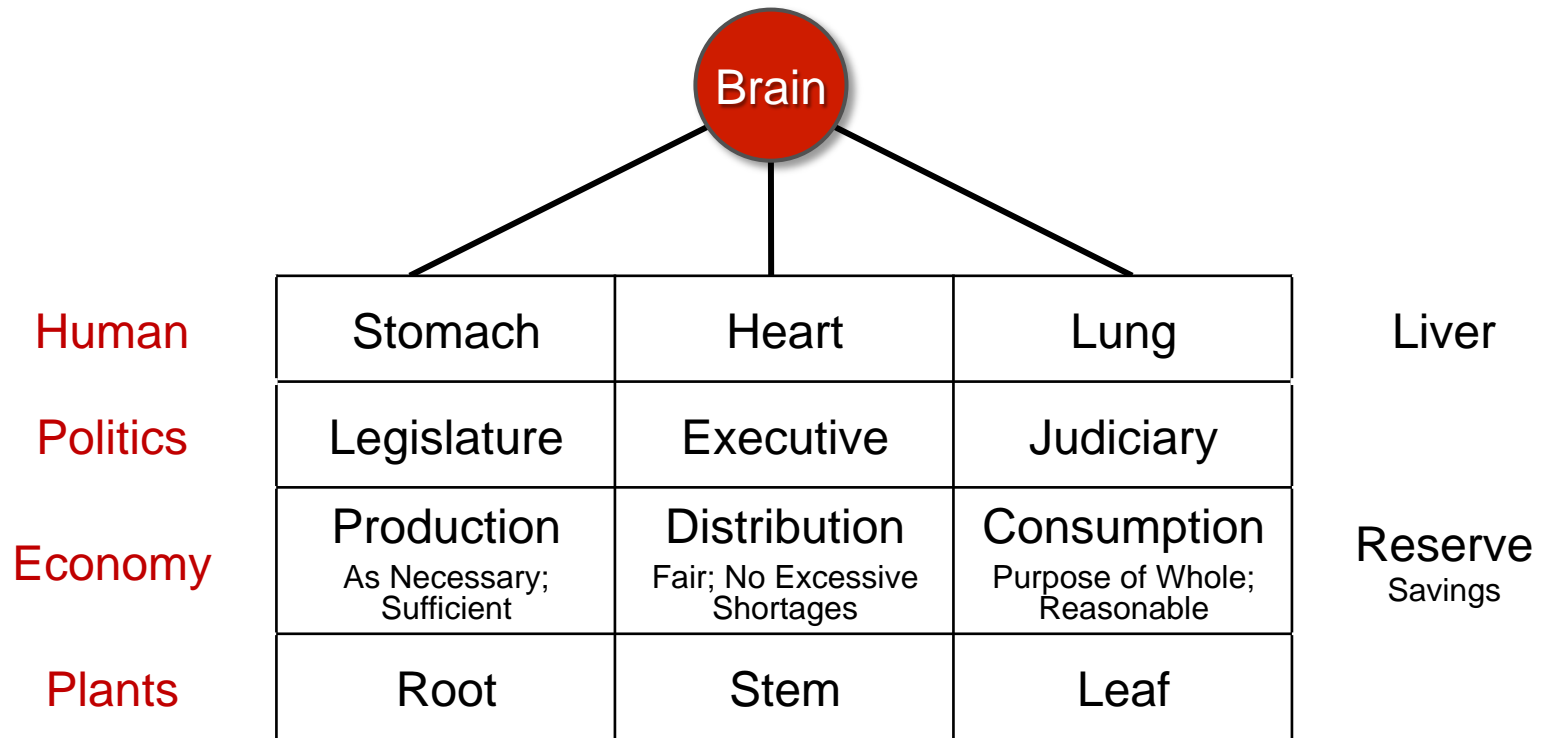

(Give & Receive Action
 Spirit of Living for Others
 Spirit of Investment)

(Mind) Heart of the Parent
 (Body) Shoes of a Servant

3) The Period for Maturation of Ideology

(1) Cain-type and Abel-type Ideologies

- i. Fallen Adam is the Womb of Good and Evil – Fallen Adam must be divided into Good and Evil.
- ii. Division of Adam (Separation)
 - { Elder Son Cain – Satan’s Side (Evil Side) → Cain-type View of Life
 - { Second Son Abel – God’s Side (Good Side) → Abel-type View of Life
- iii. Result of Division
 - { Product of Cain-type View of Life → Maturation of Ideology (Thought) from the Renaissance
 - { Product of Abel-type View of Life → Maturation of Ideology (Thought) from the Reformation

(2) Religious and Political Reformations Following the Renaissance; The Industrial Revolution

- i. Product of the Cain-type view of life, the Renaissance
- ii. Product of the Abel-type view of life, the Reformation
- iii. Three stages of political reformation
- iv. The Industrial Revolution and the society of the ideal of creation

(3) Religious, Political & Industrial Revolutions Following the Renaissance

Renaissance	1 st Renaissance (Literature)↑	2 nd Renaissance Enlightenment (Natural science)	3 rd Renaissance Materialism (Social science)↑
Religion	Reformation (Luther, Calvin)	Religious Revival (Wesley, Fox, Swedenborg)	Unification of Religions, New Expression of Truth (New Reformation) (The True Parent)
Politics	Collapse of Medieval Feudalism (Manor system) Feudal Lord → Knights, Serfs	Collapse of Absolute Monarchy (Imperialism) King → People	Society Fulfilling the Ideal of Creation Communism (Socialism) Democracy (Capitalism) Godism (Coexistence, Co- prosperity, Common Ethics)
Industrial Revolution	1 st Industrial Revolution (Steam)	2 nd Industrial Revolution (Electricity, gasoline)	3 rd Industrial Revolution (Nuclear energy)

(4) Society Fulfilling the Ideal of Creation (*Cheon Il Guk*)

Godism (Head Wing Thought)
Coexistence, Co-prosperity, Common Values
(*kong saeng, kong yeong, kong eui*)

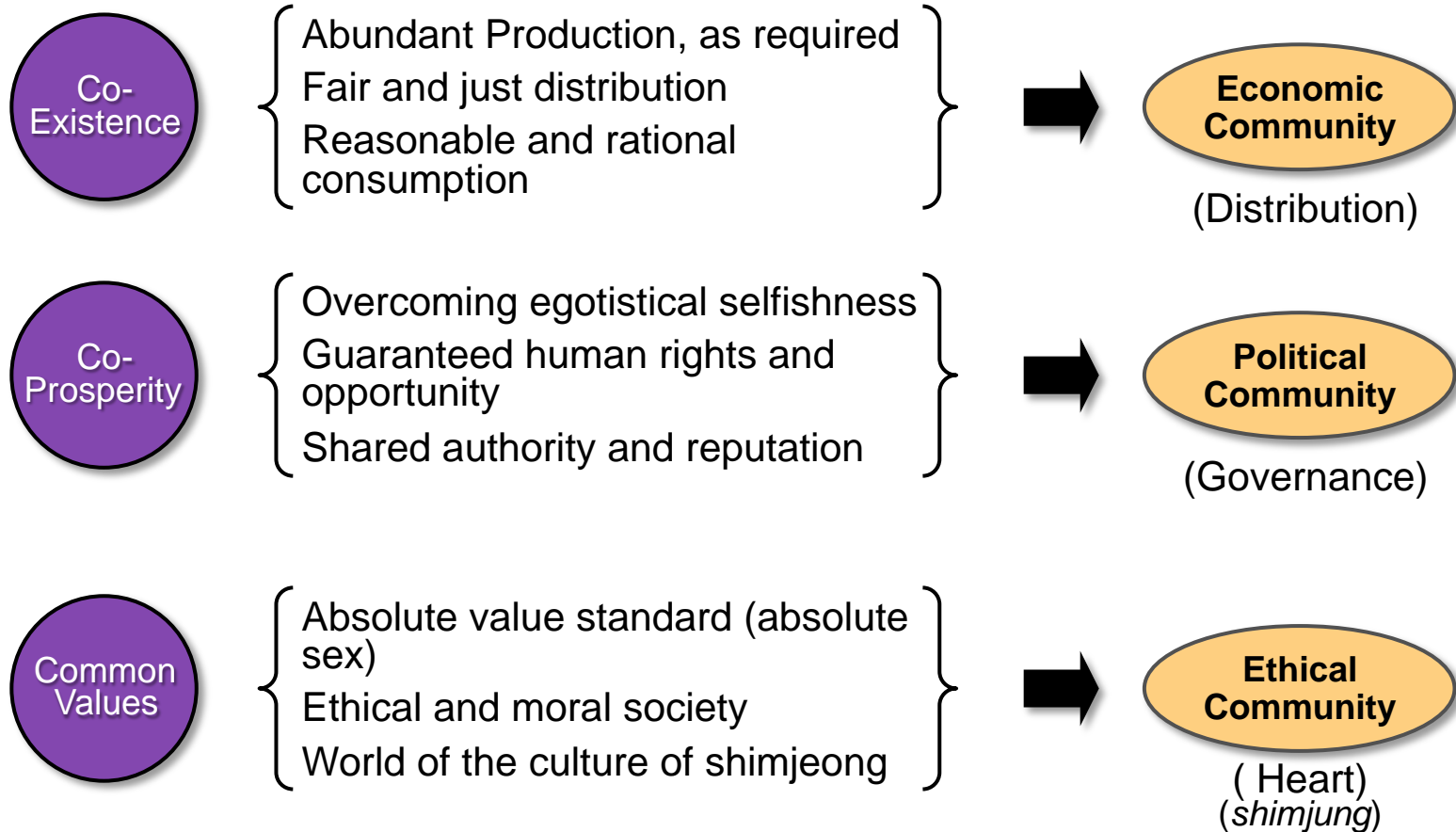

One Family Under God, One World Under God

4. The World Wars

1) The Causes of the World Wars From the Perspective of the Providence of Restoration through Indemnity

(1) Human Actions

- { Internal cause: Internal free will that seeks to adapt to the Will of God
- { External cause: External free will responding to the reality it is confronted with

(2) The World Wars

- { Internal cause: God's providence
- { External cause: Politics, Economy, Ideology

(3) Internal Cause of the World Wars

- i. Satan's last desperate struggle to preserve his sovereignty
- ii. Worldwide indemnity conditions to restore the three great blessings
- iii. Overcoming, on the global level, the three temptations put to Jesus
- iv. Global indemnity condition to restore God's sovereignty

2) Significance of the World Wars

World War I (Land), World War II (People), World War III (Ideology)

(1) Meaning of the World Wars from the Perspective of the Providence of Restoration through Indemnity

- i. Politics: Ideological confrontation
- ii. Economy: Land
- iii. Providence: Conflict between God and Satan (struggle between good and evil)

{ Substance is the shadow/image of the invisible (Hebrews 8:5).
An invisible (no form) being cannot act without a corresponding substance.
God – works to establish Ideal of Creation (Restoration) **Good** } Struggle b/n
Satan – doesn't want to let go of sovereignty **Evil** } Good and Evil

(2) The Providential Meaning of the Three World Wars

- In order to restore God's Three Great Blessings

The Three Blessings { Perfection of individuality } Adam Fall → Satan took possession
{ Perfection of family } Jesus → Three Temptations (Satan)
{ Perfection of governance } 2nd Coming → Thru the Three World Wars

(3) The Axis formed by the Three Heavenly Nations and Three Satanic Nations and Their Confrontations

World War I

(Defeated nations
- Colonies)

1914-1918
(4 years)

Imperialism
(Anti-Christian Nations)

Democracy
(Christian Nations)
(Nations Protecting
Christianity)

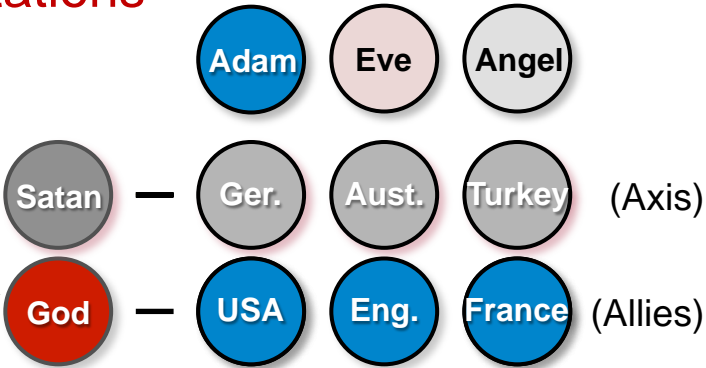

Victory
League of Nations

... 21years

World War II

(Victorious nations
- Independence of colonies)

1939-1945
(6 years)

Nations Persecuting
Christianity

Christian Nations
Nations Protecting
Christianity

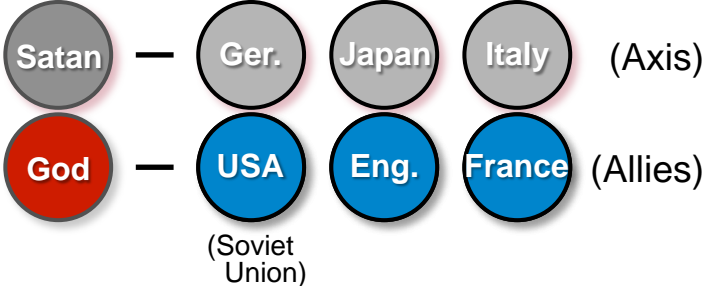

Victory
United Nations

... 21years

World War III

(World Unified by Victory
of Heavenly Side)

1966-1978
(Vietnam 12 yrs)†
1979-2000
(yrs†21)

Communist World
Nations Persecuting
Christianity

Democratic World
Christian Nations
Nations Protecting
Christianity

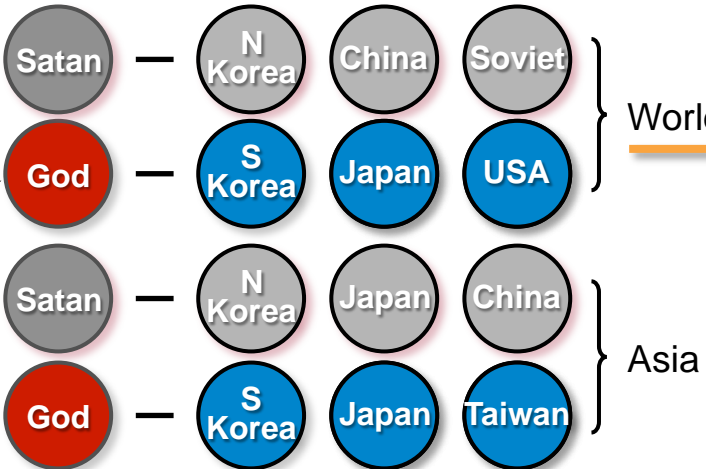

Victory
World
Government

3) Central Figures of the Satanic Side in the World Wars

	Individual Perfection-Type	Multiplication of Children-Type	Governance Over Creation-Type
I	Germany Kaiser	Pan-Germanism	Policy of World Conquest
II	Germany Hitler	Pan-Germanism	Policy of World Conquest
III	Soviet Union Stalin	Solidarity of Workers and Farm Laborers	Policy of World Communization

4) Causes and Results of the World Wars

	Causes	Results
I	<ul style="list-style-type: none">○ Formation-stage Indemnity Condition for the Restoration of Three Great Blessings○ Condition for Victory Over the First Temptation of Jesus○ Formation of the Formation-stage Foundation for the Restoration of Sovereignty	The Start (Conception) of the Work of the Second Coming in the Formation-stage
II	<ul style="list-style-type: none">○ Growth-stage Indemnity Condition for the Restoration of Three Great Blessings○ Condition for Victory Over the Second Temptation of Jesus○ Formation of the Growth-stage Foundation for the Restoration of Sovereignty	The Beginning of the Work of the Second Coming in the Growth-stage
III	<ul style="list-style-type: none">○ Completion-stage Indemnity Condition for the Restoration of Three Great Blessings○ Condition for Victory Over the Third Temptation of Jesus○ Formation of the Completion-stage Foundation for the Restoration of Sovereignty	Construction of the Kingdom of Heaven on Earth

Conclusion

The World Wars

World War I & II

→ Wars for dividing the world into good and evil

World War III

→ War for unifying the divided world

Two possible paths forward  Armed War → Imperfect
Ideological War → Perfect (Certain and clear view of the nature of God)

The Path Forward Depends on How the Human Portion of Responsibility is Carried Out

- End -

The Second Advent

I. In What Manner Will Christ Return ?

1. Will the Second Advent occur when Jesus comes to dwell within the hearts of people through the descent of the Holy Spirit? (Acts 8:16-17)

The descent of the Holy Spirit is not the Second Advent of Christ. Although Jesus has been dwelling with the hearts of faithful believers ever since his resurrection and the Holy Spirit's descent at Pentecost (Acts 2:4), the fact of their eager waiting for his Second Coming all the way until today firmly indicates that the descent of the Holy Spirit is not the Second Coming.

2. Will Jesus return as a spirit?

Even though the apostle John had frequent encounters with the resurrected Jesus who appeared in spirit, Jesus said to John, "Surely I am coming soon," to which John replied, "Amen. Come, Lord Jesus!" (Rev 22:20)

This shows that Christ at his Second Advent will not come as a spirit.

3. Will Christ return on the Clouds? (Matt 4:30, Rev 1:7)

Will Jesus really return on clouds?

We should examine it against historical facts, as history is a mirror for the future as well as a witness of the past.

Prophecies Concerning the Second Coming

{ Clouds – Matt 24:30, Rev 1:7
 In the Flesh – II John 1:7-8, Rev 12:5 }
 Biblical View

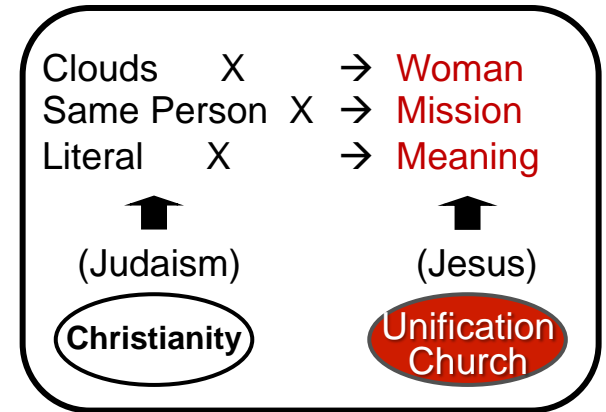

1) Historical Facts

(1) Example of Second Coming of Elijah

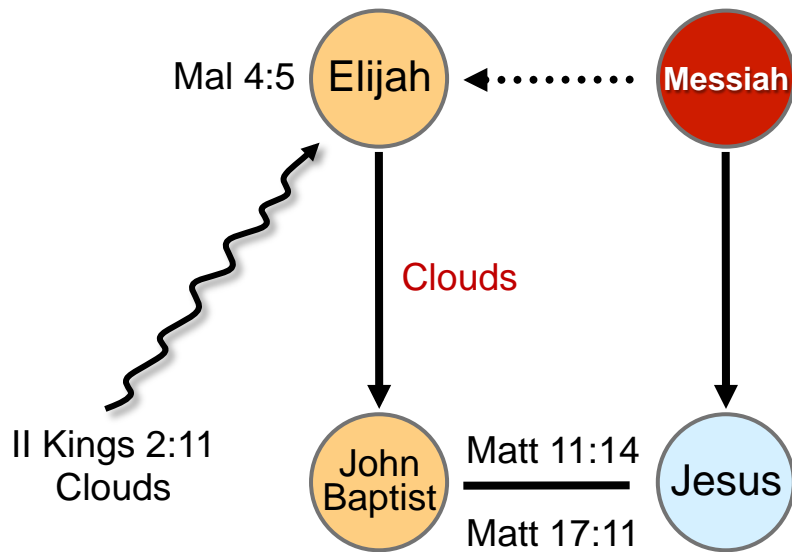

(2) Example of the First Coming

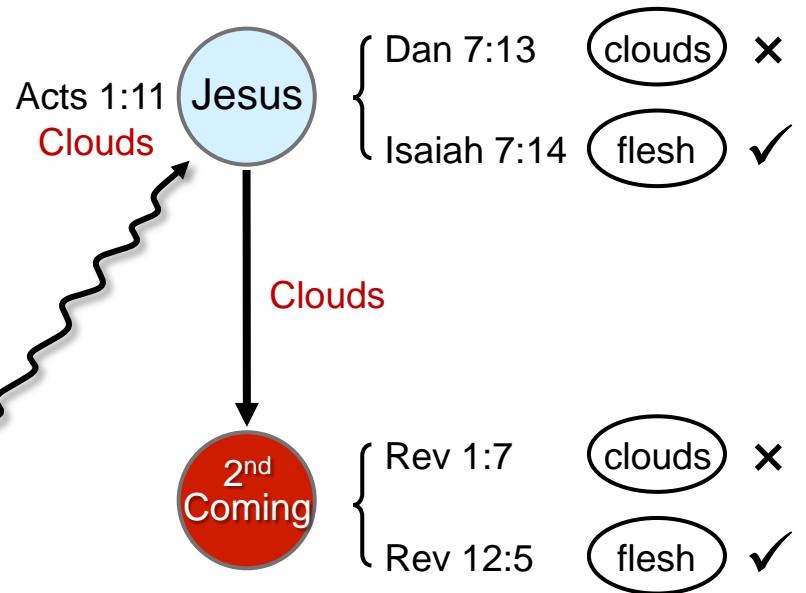

(3) From the Biblical Perspective

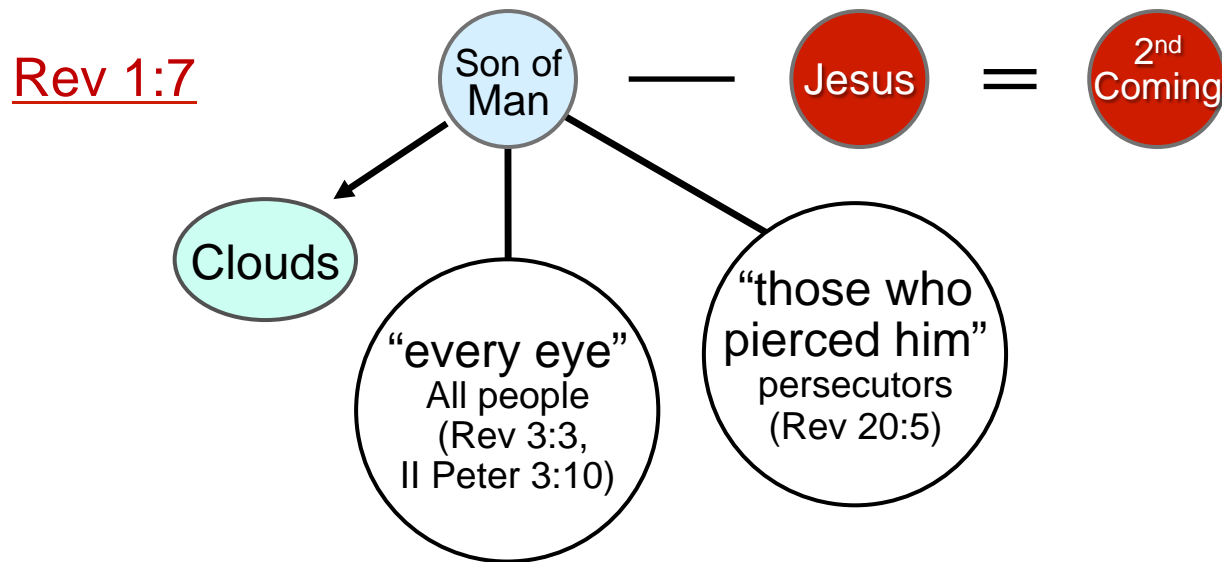

- [Luke 17:20 The coming of the Kingdom of God is not something to be observed
- [Luke 17:21 People will not say, 'Here it is,' or 'There it is,'.
- [Luke 17:22 Despite longing to see the day of the Son of man, they will not see it.

- [Luke 17:25 Suffering and rejection
- [Matt 7:21-23 "Lord, Lord, did we not ..." The Will = Know
- [Luke 18:8 Will the Lord find faith on earth?

(Many believe that Christ returns on the clouds; few believe he will return in the flesh)

(4) From the Viewpoint of the Principle

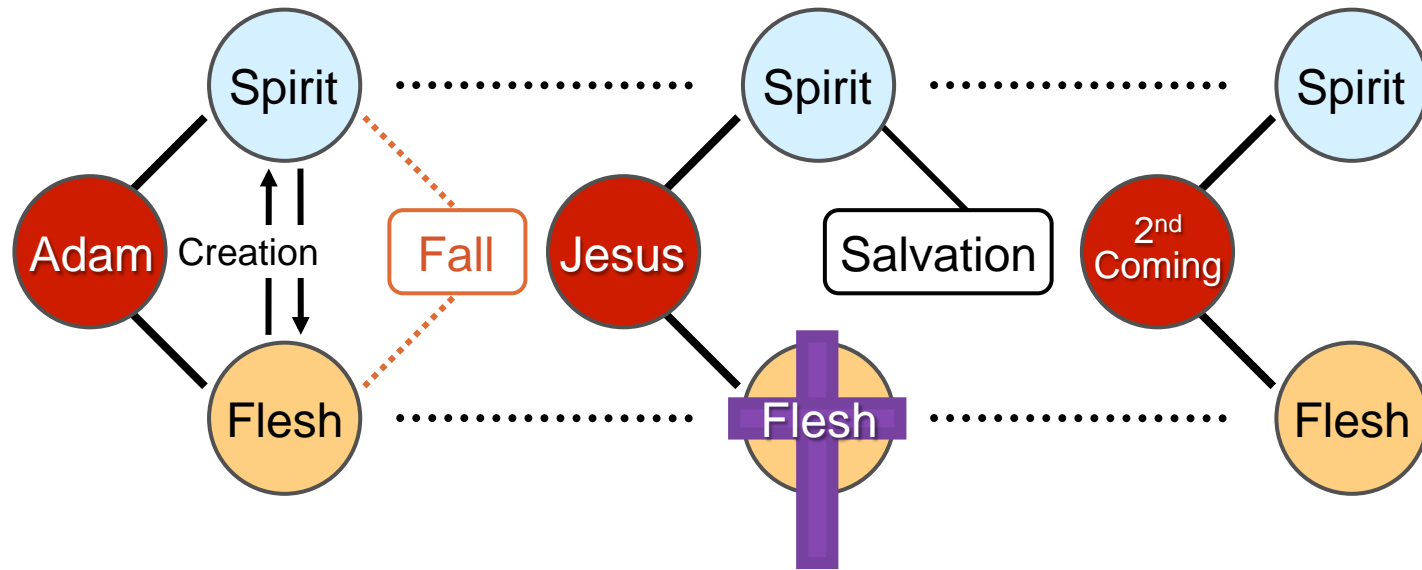

Conclusion – Born in the flesh

2) Meaning of the Clouds (Meaning of the Verses indicating that Christ Will Return on the Clouds)

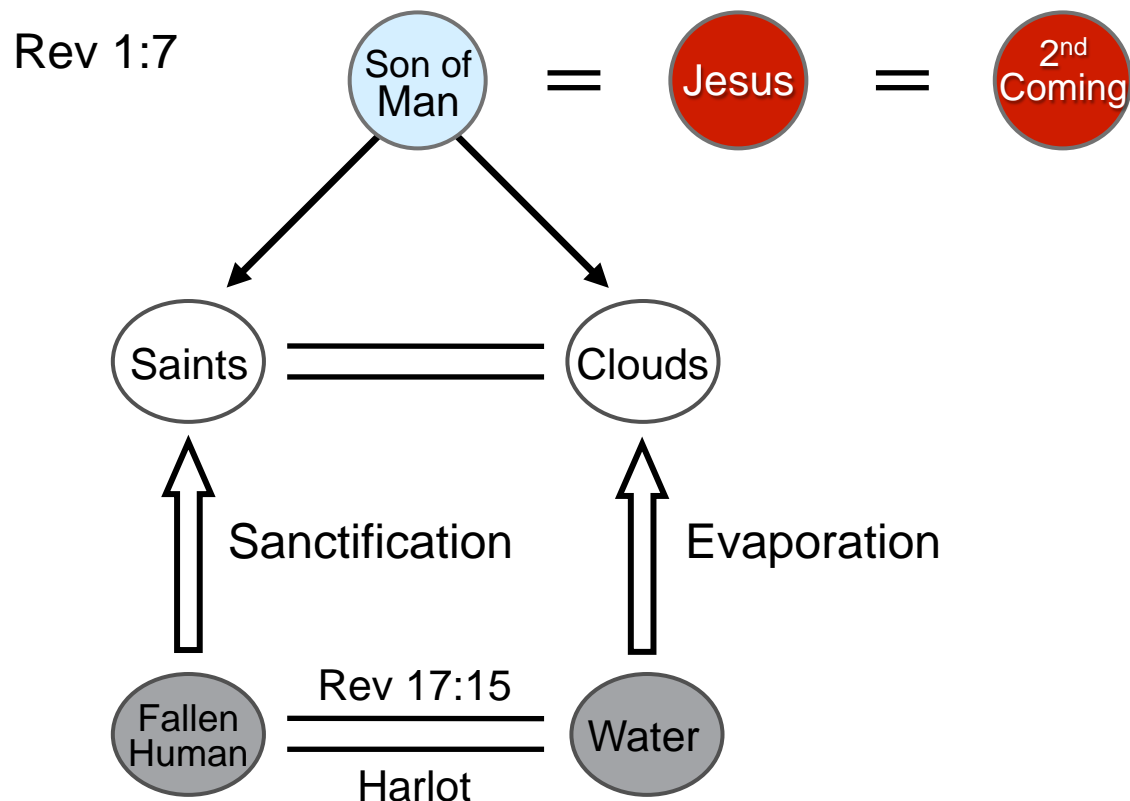

The verses stating that Christ will return on the clouds mean that he will appear in the midst of faithful believers who have been prepared.

3) Elucidation of the Meaning of Acts 1:11

“Men of Galilee,
why do you stand looking into **heaven** ?”
(Reproach)

heaven



“This **Jesus** who was taken from you into heaven,
will come in the same way as you
saw him go into heaven.”

4) The Reason Jesus declared that the Lord would come on the clouds?

- (1) To prevent deception by antichrists
- (2) To encourage Christians in their ardent faith

The Life of Jesus

- Birth in a stable
- Infancy – Refugee in Egypt
- 12 years of age - Declaring the good news
- 30 years of age - Assistant to a carpenter
- 33 years of age - Death on the cross

His was a life of constant suffering:
unbelief, hardship, persecution....

II. When Will Christ Return?

1) **Cannot know:** I Thess 5:4, Matt 25:1-13, Rev 3:3

2) **Can know:** Amos 3:7, Matt 24:36

- (1) Time of Noah
- (2) When Sodom was ruined.
- (3) When Nineveh was ruined
- (4) Birth of Jesus was known by Mary, Joseph, Wise Men of the East, but not known by priests, scribes, Pharisees, officials...

3) **How can we know?**

- i. Those who are awake
- ii. Those who are wise

How can we know the time?

1. Through the Providence of Restoration

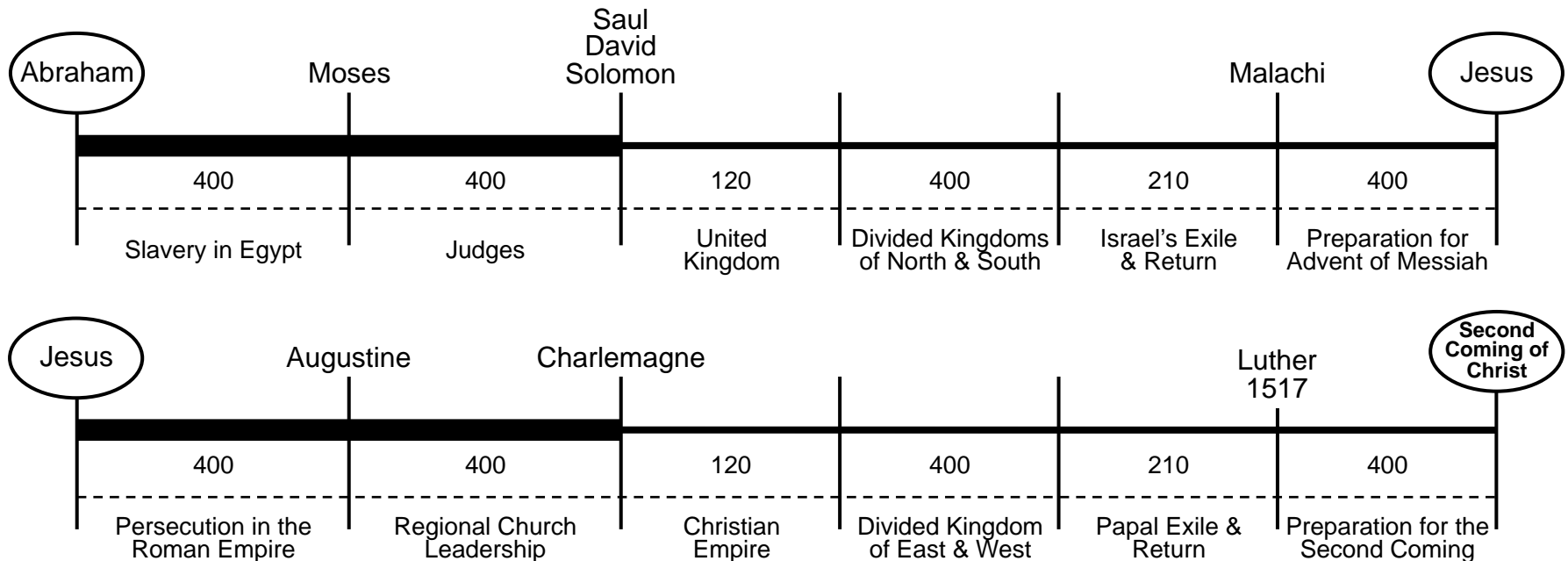

Jesus: 1930 yrs + 30 yrs after Abraham = 1960 yrs after Abraham =
Declaration of Messiahship

Second Coming of Christ { AD1917 - 1930
AD1930 + 30 yrs = AD 1960 = Holy Marriage Blessing
of True Parents

2. Through the Phenomena of the Last Days

Matt 24:32: Parable of the fig tree

(The Last Days are the time when what has been sown is harvested)

- 1) Adam: Three Blessings ✕
- 2) Jesus: Three Temptations ✓
- 3) Second Coming of Christ: Three Great World Wars

- i. World War I (1914 - 1918) - 4 years Land
AD 1919 - Conception
AD January, 1920 - Birth
- ii. World War II (1939 - 1945) - 6 years People
Start of the Messiah's Course
- iii. World War III → Ideological War Ideology
Victory of God's side - Peaceful, United World

Conclusion: Christ has already returned to Earth

III. Where Will Christ Return?

Israel
(Jewish nation)

{ Rev 7:4
Matt 10:23
Matt 16:28

to one of the Israelite tribes
in an Israelite village
some of followers will meet him
when he returns



Murder of Jesus

Israel



Victory

{ Victory of faith ✓
Victory of lineage ✗

Christ will not return to the Jewish Nation (people that murdered the Messiah)
“Through their trespass salvation has come to the Gentiles...” (Rom 11:11)

Matt.21:33 - 43

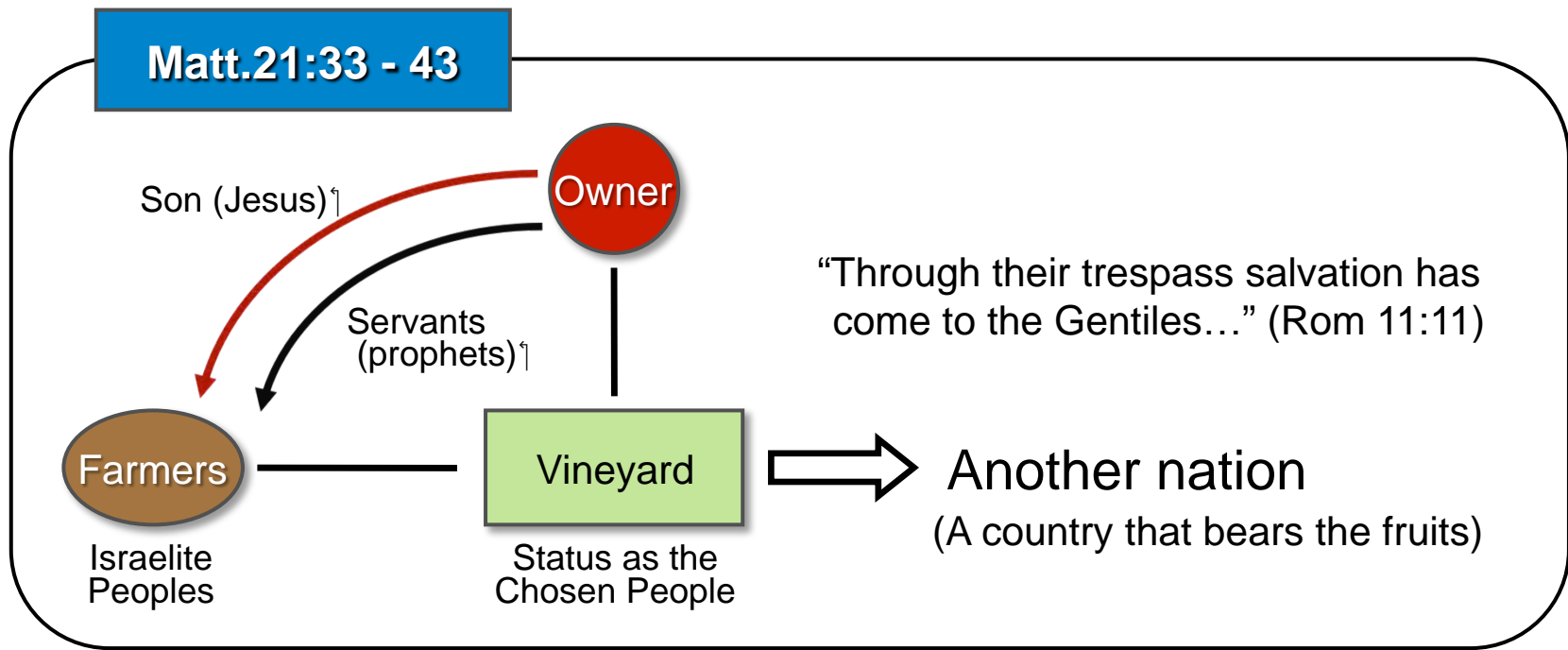

Rev 7:2 "from the rising of the sun" (The East)

Rev 7:4

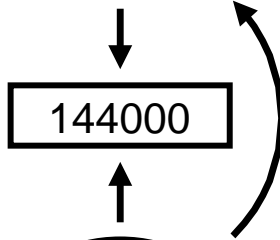

Rev 14:1



- China (Communist nation, Invaders, Religious persecution)
- Japan (Invasive nation, Religious persecution)
- Korea (A Righteous Nation)

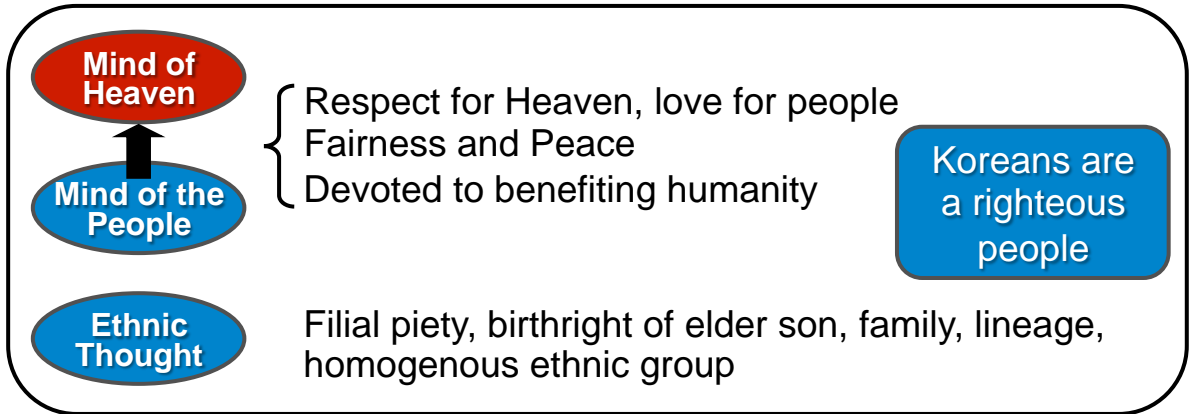

IV. The Nation where Christ Returns must fulfill the following conditions

1. Number 40-based Condition of Indemnity as a People
2. Nation that is a Sacrificial Offering
3. Nation that is an Object to God's Heart
4. Nation Bearing the Fruits of Civilization
5. Nation with Messianic Prophecies

1. Number 40-based Condition of Indemnity as a People

- 1) 1st Israel (Jewish people)
 - 400 years of slavery in Egypt
- 2) 2nd Israel (Christianity)
 - 400 years of persecution under the Roman Empire
- 3) 3rd Israel (Korea)
 - 40 years of persecution under Imperial Japan (1905 - 1945)

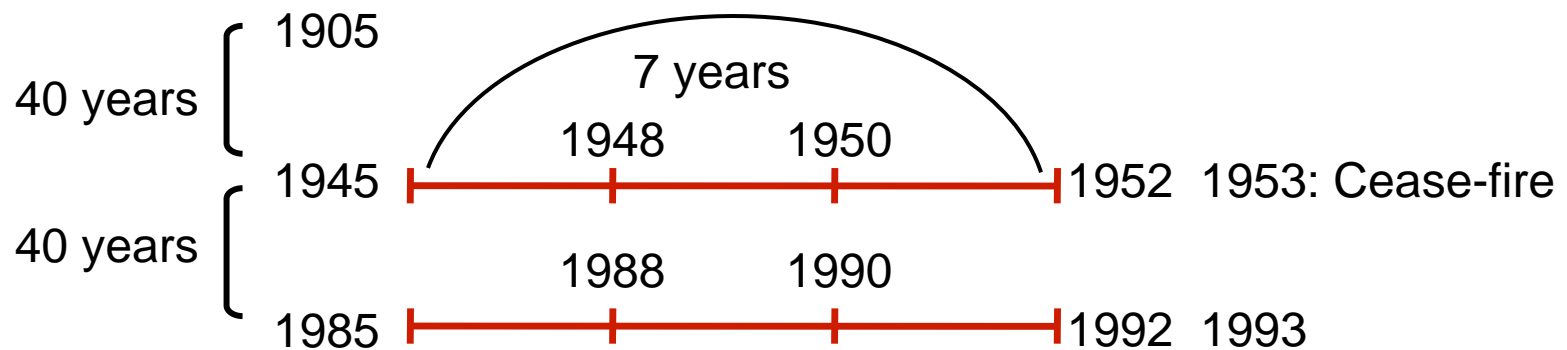

2. Nation that is a Sacrificial Offering (Frontline between God and Satan)

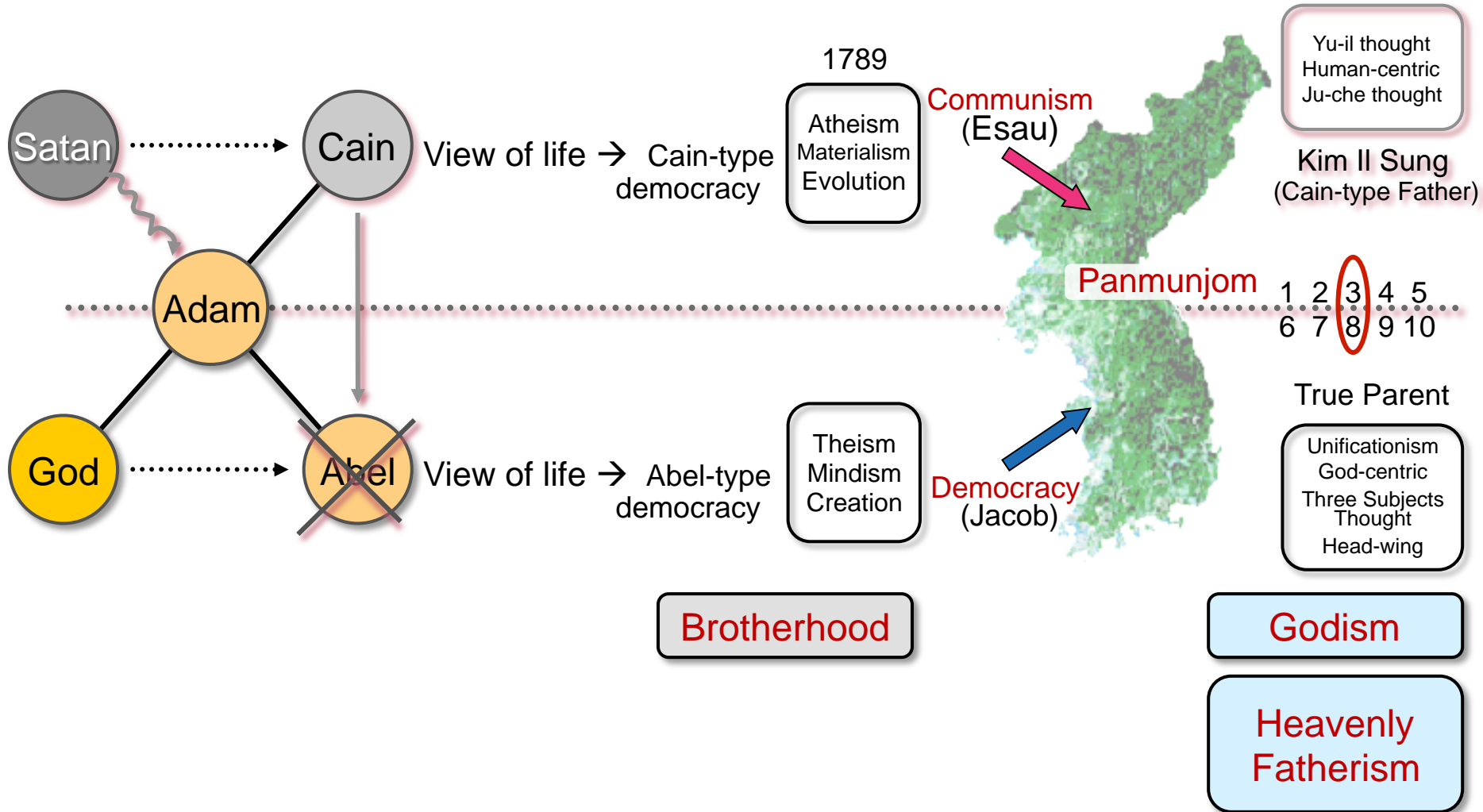

3. Nation that is an Object to God's Heart

(A people that God loves most)

1) God's *shimjung* (heart)

God's <i>shimjung</i> at creation	= Joy (Hope)↑
God's <i>shimjung</i> at the human fall	= Sorrow (Tears)↑
God's <i>shimjung</i> of restoration	= Suffering (Grief)

2) God: a God of suffering, a God of sorrow, a God of *han* (blood, sweat & tears)↑

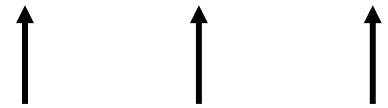

3) Koreans are a people of suffering, sorrow, *han* (blood, sweat & tears)↑

Movies – Sorrowful Themes (of loyalty, filial piety and chastity)↑
Language – Sorrowful heartistic expressions (“bone-melting sorrow”)↑
Expression – Sorrowful words & phrases↓ (birds “cry”, paper strips “cry”)

4) The Korean people are a moral people

(1) Korean Ethnic Thought

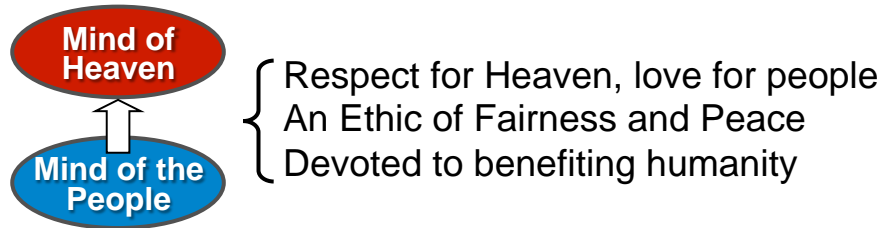

(2) Eastern Nation of Propriety

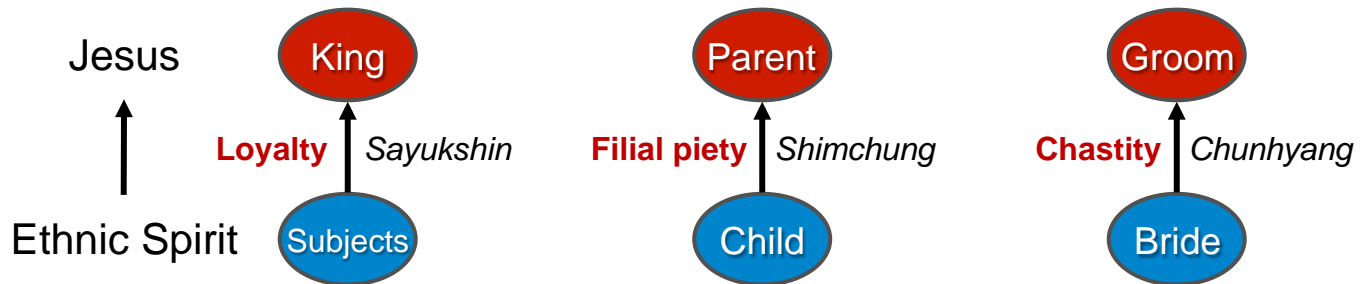

(3) What the Korean people should show to and teach the world

- God is the True Parent of Humankind
- Philosophy of loyalty, filial piety and chastity
- Victory over communism thought
- Philosophy of Attendance (attending to one's parents)†
- Absolute sex ideology (God's ideology – Root Substance of the Principle) (OSDP)

(4) Dae Han Min Guk (Republic of Korea): Name of Greatness

Traditional clothes (beautiful, ascetic): Traditional hat “gat” = “GOD”

Hangul characters (highly recognized): the best language to express the realm of God’s heart

Korean food (composite menu) †

Korean People (a brilliant people): IQ ranks 1st to 4th in the world

(5) Way of Thinking

[Western way: dialectic	→	swords and spears
	Korean way: give & receive	→	chopsticks and spoons

(6) Korean Ethnic Traditions

- Filial Piety (Loyalty & chastity)
- Birthright of the Eldest Son
- Family
- Lineage (strict family tree records - “jok·po”)
- Nation

4. Nation Bearing the Fruits of Civilization

1) Continents

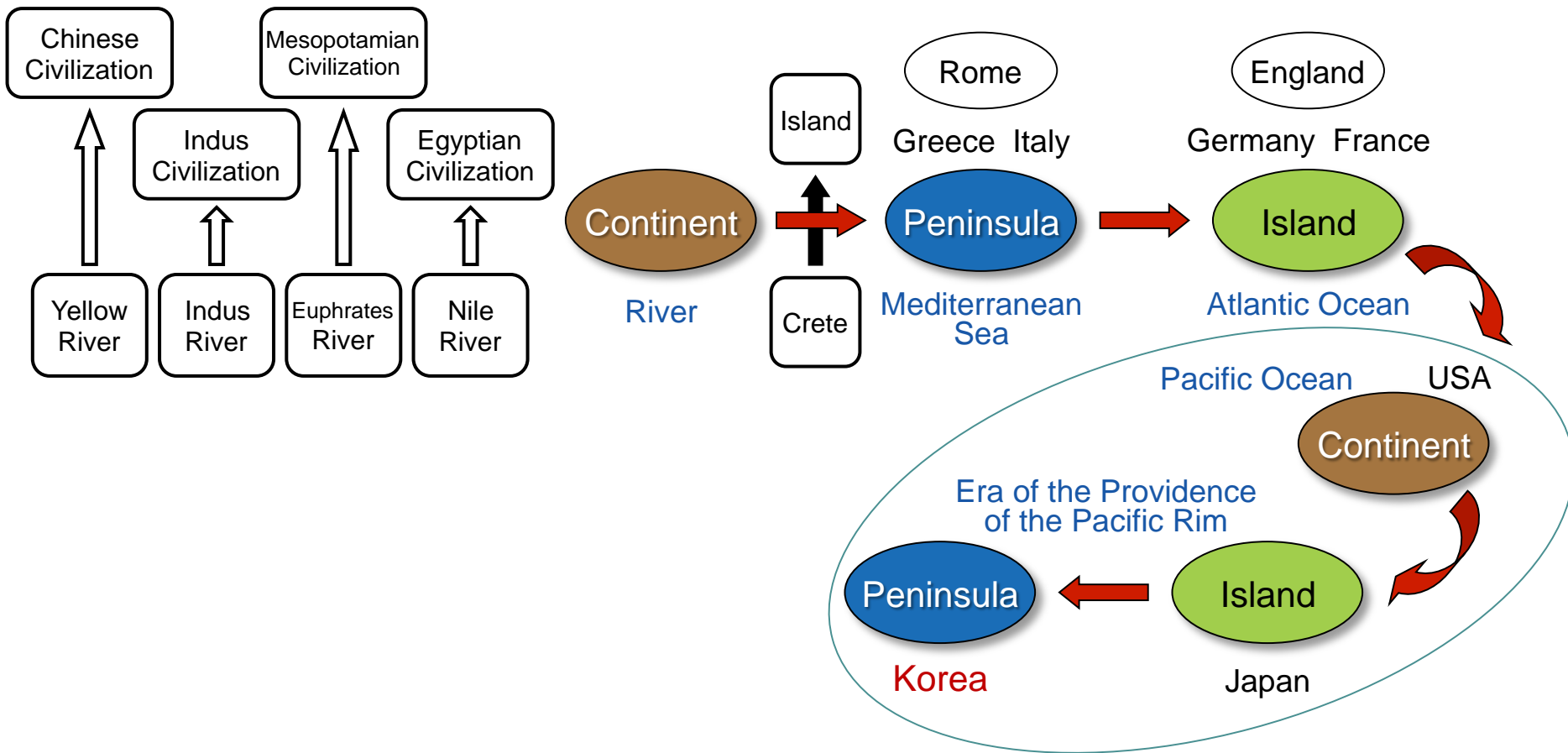

2) (Rivers) → Mediterranean Sea → Atlantic Ocean → Pacific Ocean

3) Fruits of Civilizations centering on Climate

One year	Spring	Summer	Autumn	Winter
One day	Morning	Afternoon	Evening	Night
Whole life	Childhood	Youth	Middle age	Old age
Climate-type civilization	Temperate-zone civilization	Tropical civilization	Sub-tropical civilization	Polar civilization

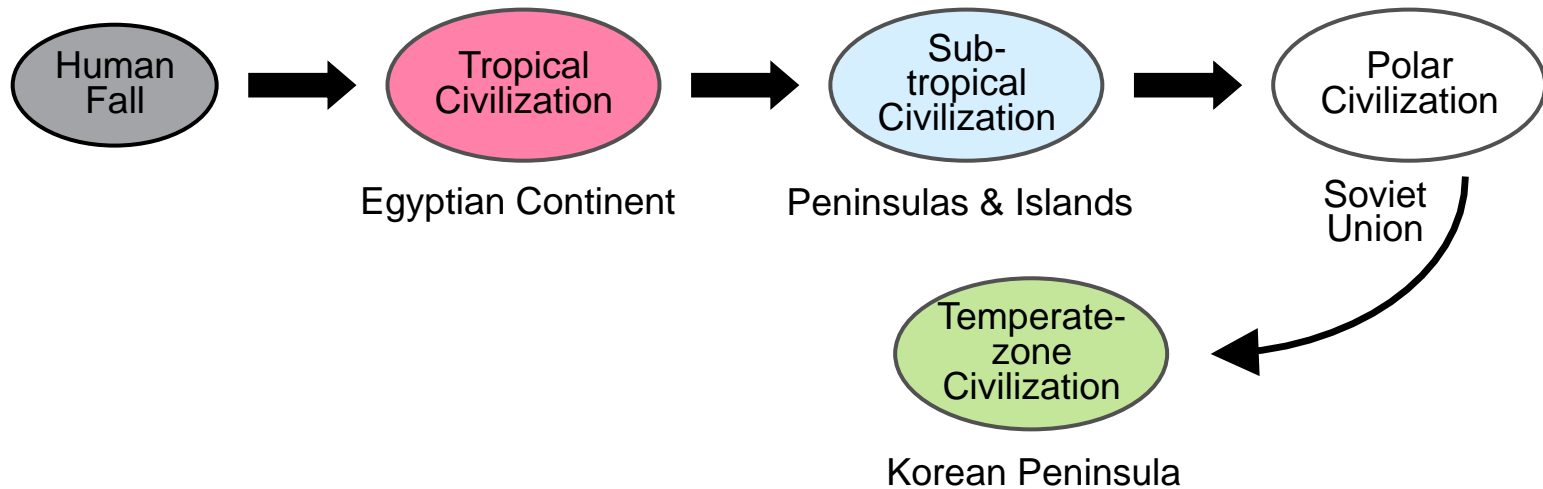

4) Nation bearing the fruits of religion (A Moral People)

All the ideologies and religions have arrived in Korea and borne fruit.

Three Nations Era (AD.1 - 7 c.) – Buddhism (from India)

Yi Dynasty Era (15 - 19 c.) – Confucianism (from China)

Modern Era (20 c.) – Christianity (from Europe & West)

21 Century – Unificationism (originated in Korea)

5. Messianic Prophecies

1) “Chong gam nok” (Korean book of prophecy)

An ethnic faith deeply held by the Korean people since the era of the Yi dynasty

利在松松: Japanese invasion of 1592

利在家家: Chinese invasion of 1636

利在八金山: 6.25, Korean War

利在田田道下止: the present day

辰·巳 (2000, 2001) -
Appearance of a sage

午·未 (2002, 2003) -
Realization of happy families

2) Pastors: received and proclaimed the revelation that the Second Coming of Christ would take place in Korea

Era of Japanese Imperialism: Kim Jae Bok, Kim Yik Doo

6.25: Son Yang Eun

3) Elders: Loudly proclaimed the coming of Christ to Korea

Pak Tae Seon, Ra Un Mong (1950 - 60s)

4) Common believers: Many believers received the revelation that the Second Coming of Christ would take place in Korea.

5) Jesus: Was testified to by the three wise men of the East

Second Coming of Christ (LSA): Testified to by wise men of the West

- Arnold J. Toynbee (Historian)
Politics and economy shall be resolved by the USA and Soviet Union, while ideology will be resolved by a new religion which appears in the East.
- Arthur Ford (President of the Society for Psychical Research in US)
“Rev. Sun Myung Moon was sent by God. Nonetheless, people are spiritually blindfolded, even though they see him. Thus, they remain ignorant of God.”
- Lavers S. Corde
visited Korea in 1970s to look for the living God.†
- Mrs. Jeane Dixon (Prophet, the 21st century)
“Rev. Sun Myung Moon is the greatest spiritual leader of the 20th Century and was sent especially by God for the sake of humanity.”
- Kiyoshi Nasu (Author of ‘The Savior in prison’, former correspondent for Japanese Mainichi Newspaper in Washington D.C., commentator on diplomatic ties) ♪
- Dr. Kim Eun Woo : “‘White Paper on Christianity’ - Who will save this world?”
- Dr. Yoon Se Won : “Rev. Moon is the Messiah.”

6) Poem 'A light of the East' (1927) by Rabindranath Tagore (Nobel Prize for Literature, 1913)

From 'Gitanjali' ('Song offerings')
No. 35 (of a total 103 songs)

In the golden age of Asia
Korea was one of its lamp - bearers
And that lamp is waiting to be lighted once again
For the illumination in the East.

Gitanjali 35

Where the **mind** is without fear and the **head** is held high; Hope

Where **knowledge** is free ;

Where the world has not been broken up
into fragments by narrow domestic walls; Unification

Where **words come out from the depth of truth**; Truth

Where tireless striving stretches its arms towards **perfection**; Perfection

Where the clear stream of **reason** has not lost its way
into the dreary desert sand of dead habit; Eternity

Where the mind is led forward by thee into
ever-widening thought and action --

Into that heaven of freedom, my Father, let **my country** awake. My country

7) Ae-Guk-Ka (National Anthem of Republic of Korea)

1. Until that day when Mt. Baekdu is worn away and the East Sea's waters run dry,
May God preserve our country, our long-living homeland!
2. As the pine atop Namsan Peak stands firm, unchanged through wind and frost,
as if wrapped in armor, so shall our resilient spirit.
3. The autumn skies are void and vast, high and cloudless,
the bright moon is like our heart, undivided and always true.
4. With this spirit and this mind, let us give all loyalty,
in suffering or joy, to love our nation!

(REFRAIN) Rose of Sharon, three thousand li full of splendid mountains and
rivers;

Koreans, to the Korean way, stay always true!

In the future, the people of the world will come to Korea.
Let us attend the Coming Christ and manifest the glory of God's homeland!

6. Who is Rev. Sun Myung Moon?

- 1) Messiah — Son of God (the true filial son)
- 2) Savior — The one who saves the family
- 3) Second Coming of Christ — Unification of religion, liberation of religion
- 4) The True Parent — The Blessing (rebirth)
 - ❖ The Blessing = the greatest gift of the Messiah given to humankind
- 5) The True Parent of Heaven, Earth & Humankind — The substantial manifestation of the True God
- 6) The King of Cosmic Peace — Liberation and release of God, the restoration of God's homeland

7. Evidence testifying to the True Parent

1) Testimony by world leaders from various disciplines

The True Parent is the historical champion in 8 different dimensions:

- (1) The champion of knowing God
- (2) The champion of knowing the reality of Evil
- (3) The champion of understanding human beings
- (4) The champion of knowing the Spirit World
- (5) The champion of knowing Jesus
- (6) The champion of knowing the Bible
- (7) The champion of knowing the meaning of history and the root and origin of religion, philosophy and ideology
- (8) The champion of the ideal of true families

2) Testimony by the representatives of the 5 Great Religions (Resolution by the representatives of the 5 Great Religions, December 25, 2001)

(1) Program

Date - Noon, December 25, 2001. MC - Dr. Sang Hun Lee

1. Opening: We will now conduct the ceremony for adopting the proclamation of a written resolution by the representatives of the five great religions.
2. Family Pledge: All together
3. Proclamation of the written resolution: Jesus Christ
4. Representative prayer: Jesus Christ
5. Three cheers of Mansei: Mohammed
 - Mansei for God, Mansei for True Parents, Mansei for the Five Great Religions
 - The ceremony concluded with applause

(2) Seating Arrangements

1. Front row: representatives of the Five Great Religions
2. 12 other representatives of each religion
3. 120 representatives of each religion

(3) Jesus' Prayer

We five great religions, attending God the Father above us and True Parents on the horizontal level, pledge and proclaim that we will go the way of absolute obedience, in order to correct all of the wrongs committed throughout history.

I report this in the name of Jesus, a blessed central family. Amen, Amen, Amen!

(4) Written resolution by the Representatives of the Five Great Religions

- i. We resolve and proclaim that God is the Parent of all humankind.
- ii. We resolve and proclaim that Reverend Sun Myung Moon is the Savior, Messiah, the Second Coming and the True Parent of all humanity.
- iii. We proclaim that the Unification Principle is the message of peace for the salvation of humanity and the gospel for the Completed Testament Age.
- iv. We resolve and proclaim that we will accomplish the peaceful unification of the cosmos through "living for others" while transcending religion, nationality and race, centering on true love.
- v. We, the representatives of the Five Great Religions, resolve and proclaim that we will harmonize with one another, unite and move forward, in order to bring about world peace and the nation of God, while attending the True Parent.

3) A Message from God♪

My beloved True Parent,

I am Jehovah, the Lord of Hosts. I am Jehovah, the Lord of Hosts.

I am Jehovah, the Lord of Hosts.

My beloved Child! My beloved Child! My beloved Child!

I, Jehovah, the Lord of Hosts, deeply love the True Parent. How can I express my gratitude and appreciation for you?

If there was any better expression than to say “I love you”, then I would use those words, that expression, but I can find none.

You, the True Parent, reside deep within My heart, and my love for you is beyond description.

You have been victorious on every level and have restored everything to its proper position.

You are the Savior of humankind and the Messiah. Is it not fitting that you are now in the position of the King?

Considering that Christianity and the other major religions adopted a resolution and determined to unanimously move forward while attending the True Parent, it is right and fitting that you now are crowned as the True Parent of all humankind. Indeed, this is the will of Jehovah, the Lord of Hosts.

Although the people of the world do not fully understand, nonetheless, the internal position must be filled; it must be established.

Accordingly, I, Jehovah, the Lord of Hosts, hereby bestow upon you, my beloved True Parent, the position of King.

Those many times in prison, those places of suffering, you entered and endured those places all in place of me.

Therefore, now, from the heart of Jehovah, the Lord of Hosts, I wish to invest in you all my gratitude, adoration, zeal and appreciation.

Now, I want to give everything to you, True Parent, I want to bequeath everything to you.

My beloved True Parent! God has been complaining in his heart so many days, but today is a day I was never able to see!

But now, the heart of Jehovah the Lord of Hosts has been understood.

Therefore, at this precious and special moment, I wish to convey to my beloved True Parent my heart of gratitude. Indeed.

The True Parent, my beloved, the True Parent!

I want to embrace you forever and never let you go!

I want to carry you on my back and never let your feet touch the ground!

I want to embrace you and talk together all night long.

Jehovah the Lord of Hosts trusts you. I trust the True Parent. I know all the heartbreaking situations you have faced, the bone-melting suffering and sorrow.

I know them all. I remember them all. I witnessed them all!

I was responsible for placing you in those situations. They are all My doing, My fault!

Nonetheless, you endured them all and set the standard of victory. How can Jehovah, the Lord of Hosts, ever forget you, the True Parent?

Thank you, thank you, for your dedication and toil, I thank you!

Mansei for my beloved True Parent!

Mansei for the savior of humanity!

Mansei for the True Parent, the King of Kings!

This message, I Jehovah, the Lord of Hosts, convey to my beloved, the True Parent.

December 28, 2001

The True Parent and the Completed Testament Age

(Completion, Conclusion and Finalization
of the Providence of
Restoration Through Indemnity)

Overview

The providence of restoration began directly after the moment that Adam and Eve fell.

The providence of restoration is divided up into 3 distinct divisions: the Old Testament era, the New Testament era and the Completed Testament era.

The era for the providence of the foundation of restoration, the era for the providence of restoration, and the era for extension of the providence of restoration are all completed, concluded and finalized centering on and through the True Parent, who is the returning lord.

The 2000 years from Adam to Abraham form the era of the providence of the foundation of restoration.

The 2000 years from Abraham (Jacob) to Jesus Christ form the era for the providence of restoration.

While Jesus was intended to complete the providential course for the substantial restoration of Canaan, due to the disbelief of the Israelite people, the Jewish leadership and the disciples, he died on the cross promising to 'return again'.

Through his death on the cross, Jesus was unable to complete the providential course for the substantial restoration of Canaan, and during the 2000 years since he made his promise to return, he conducted and completed the providential course for the global restoration of Canaan in spirit.

Accordingly, the providence of restoration centering on Jesus was prolonged, and the entire providence of restoration is completed, concluded and finalized by the True Parent, who appears as the returning lord, obtaining victory in the providential course for the cosmic restoration of Canaan.

Subsequently, with the emergence of the 'Hwegi' era (Era of the Period of Return) centering on Foundation Day, God comes to directly conduct his providence in substance on the spiritual and physical worlds centering on the True Parents.

I. The True Parent and the Completed Testament Era

1. God's Ideal of Creation 1) God's Promise

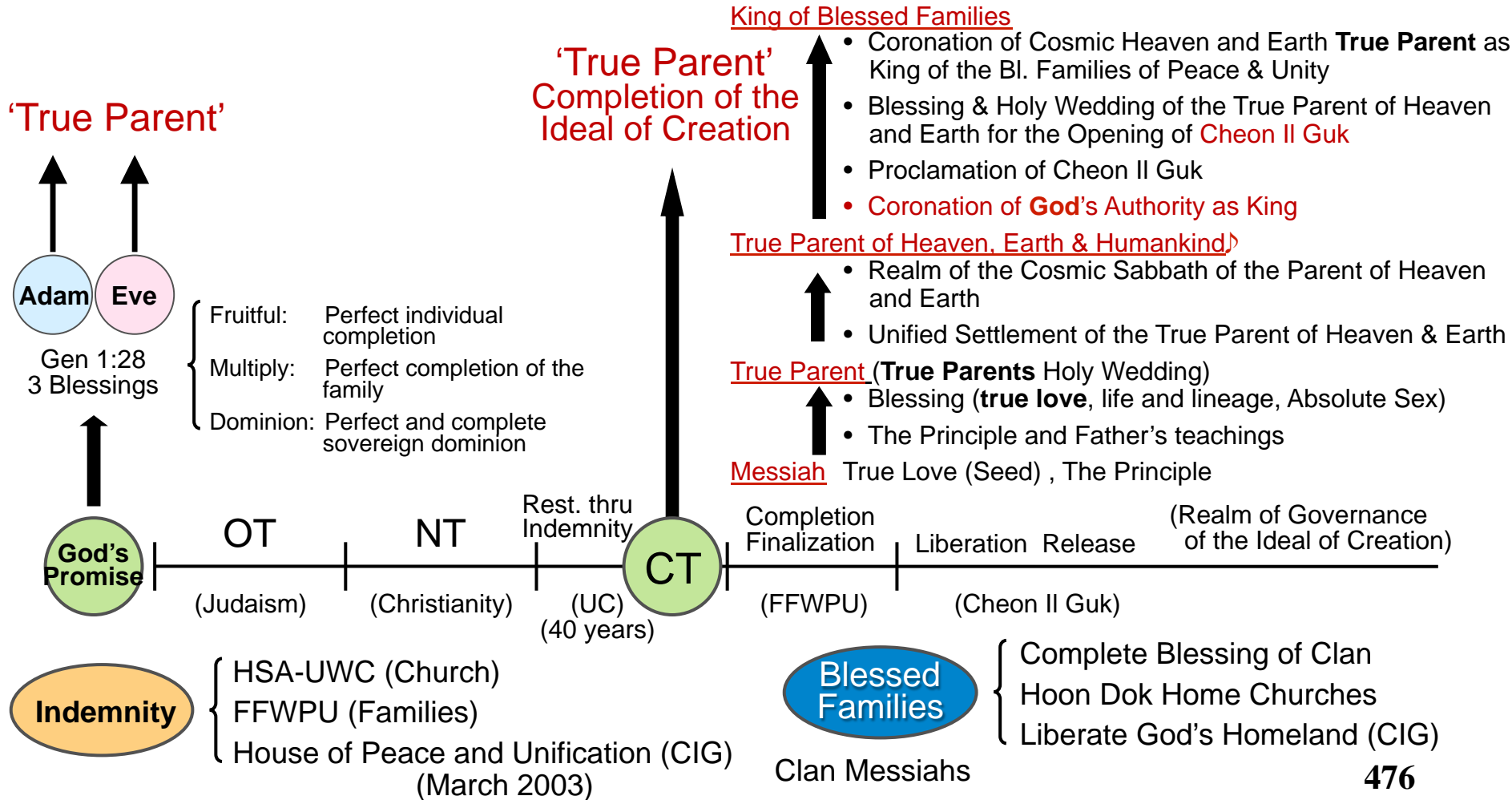

Completion, conclusion & finalization of the final oneness of True Parents

Proclamation of the Substantial Word for the Settlement of the True Parent of Heaven, Earth and Humankind (8 Great Textbooks)

God's fatherland and homeland is Dae Han Min Guk

Coronation Ceremony for the Realm of the Liberation of God, the King of Kings

True Parent of Heaven and Earth, the King of Cosmic Peace (Coronation ceremony for entrance into the Cheon Jung Gung palace)

King of Blessed Families

- Coronation of Cosmic Heaven and Earth **True Parent** as King of the Bl. Families of Peace & Unity
- Blessing & Holy Wedding of the True Parent of Heaven and Earth for the Opening of **Cheon Il Guk**
- Proclamation of Cheon Il Guk
- Coronation of **God's Authority as King**

True Parent of Heaven, Earth & Humankind

- Realm of the Cosmic Sabbath of the Parent of Heaven and Earth
- Unified Settlement of the True Parent of Heaven & Earth

True Parent (True Parents Holy Wedding)

- Blessing (**true love**, life and lineage, Absolute Sex)
- The Principle and Father's teachings

Messiah True Love (Seed) , The Principle

Completion Finalization (FFWPU) | Liberation Release (Cheon Il Guk) | (Realm of Governance of the Ideal of Creation)

Indemnity

- HSA-UWC (Church)
- FFWPU (Families)
- House of Peace and Unification (CIG) (March 2003)

Blessed Families

Clan Messiahs

- Complete Blessing of Clan
- Hoon Dok Home Churches
- Liberate God's Homeland (CIG)

2) Fundamental Law of the Cosmos

The fundamental law of heaven and earth is the father-son relationship. It is not the father-daughter relationship, nor is it the mother-son or mother-daughter relationship.

The relationship between God and human beings is the father-son relationship. God is the father of human beings, and human beings are God's children. Adam, the ancestor of human beings, is God's son, and is God's body. Eve is God's daughter and is Adam's bride.

As the father, God is the 1st generation and as the son, Adam is the 2nd generation. God created the 1st and 2nd generations, but the 3rd and 4th generations are multiplied through Eve. It is here that the 4-position foundation, the purpose of God's creation, is perfectly completed.

God's true love is encountered and met through men and comes into our possession through women.

Accordingly, if God is the subject, then Adam stands as object, and when Adam becomes one body with God, then when Adam is subject, Eve stands as object. Men, who are the subject and women, who are the object, resemble God and so like God, become the personalized substance and body of true love. With the heart to live for others and the heart to invest and give, they must live a life that exemplifies the Principle, the heavenly law and the heavenly order.

For a human being to become a substantial embodiment of *shim jung* and absolute sex which resembles God, who is the root and original body of *shim jung* and absolute sex, he or she must, as God's child, form an ideal family and live in attendance to God.

Subject and object have a relationship that is analogous to the relationship between a train and the tracks. If a train leaves the tracks, it can no longer advance. Likewise, if a husband, who is subject, and a wife, who is object, depart from the Principle, they can no longer proceed towards God. Thus, they must continuously think of the path of the Principle and live in a Principled manner.

In the relationship between a husband, who is subject, and a wife, who is object, if either of these changes his or her position, the two of them can no longer advance, and the other party must wait until the first party returns to his or her position. This, then, is what the Completed Testament Era is: it is the era in which human life is expanded to a family, clan, ethnic group, nation, world and cosmos centering on *shim jung* (heart) and absolute sex through the practice of a life that embodies the Principle, heavenly law and heavenly order.

2. The Completed Testament Era is the Era of True Parents.

1) The birth of True Parents

(1) True Father (Sun Myung Moon)

- i. Born on Jan. 6 1920 (lunar) (solar: Feb. 25) (*kyung shin* year)
- ii. Born as the 2nd son in a family of 2 boys, 6 girls to his father, Mun Kyung Yu and mother Kim Kyung Gye
- iii. 2221 Sangsa-ri, Deok-Eon-myeon, Jungju-gun, Pyung An-bukdo

(2) True Mother (Hak Ja Han)

- i. Born on Jan. 6 1943 (lunar) (solar: Feb 10)
- ii. Born as an only child to her father, Han Seung Oon and mother Hong Soon Ae
- iii. 26 Shin-eui-ri, Anju-eup, Anju-gun, Pyung An-namdo

2) Restoration of the True Parents through Indemnity

The True Parent (Father) arrived on earth and walked a path of indemnity of innumerable sufferings.

- (1) Born under the forced Japanese occupation
- (2) At age 15, inherited the mission of Jesus Christ
(dawn, Easter Sunday, April 17, 1935)

i. Uncovering the Principle

- Searched for and organized the Principle over 10 years (1935 – 1945)
- Difficulty of finding the Principle, difficulty of meeting the True Parent

ii. Tested by the temptations of women

- Father had to gain victory over the temptations of women before he was 23
- Victory over temptations of women → God entrusts him with responsibility for all women.

iii. Imprisonment and torture

- Imprisonment & torture under Japanese Imperialism (Ind. Movement)
Kyung-gi-do Police Station
- Imprisonment & torture under NK Communists (teaching the Principle)
 - Pyongyang Daedong Precinct Station (100 days) , Heungnam Concentration Camp (2 years 8 months)
 - Feb. 22 1948 – Oct. 14 1950: Heungnam Forced Labor Camp
 - Providential victory: liberation by UN forces (Father 30 yrs old) , Joseph
 - Made Prime Minister of Egypt at 30 yrs of age. Jesus to be king of Israel at 30 – Crucified through the faithlessness of Israelites, Judaism. Father gained victory in restoring the crucifixion of Jesus' thru indemnity.
 - Arrangement of *Wolli Wonbon* (May 10 1951 – May 11 1952),
Declaration of Principle in 1953 (Father = 33 yrs old)

iv. Establishment of HSA-UWC (May 1, 1954)

- Seo-Dae-Mun Prison (1955 – Ihwa University Incident)
- Released as innocent within 100 days (opposition to collusion between govt. and Christians)
- Opposition by Christianity, which was supposed to fulfil mission of Bride of the LSA (restored thru indemnity over 40 years)

2) Declaration of Pal Jung Shik (Settlement of 8 Stages) and Heavenly Fatherism

(1) Declaration of Pal Jung Shik (Kodiak, Alaska August 31, 1989)

- i. Restoration of Elder Son's Authority (April 7 – 11, 1990 Summit w/ Gorbachev)
 - Victory in 3 rallies in USA, elder son nation on heavenly side
(Madison Sq. Garden, Yankee Stadium, Washington Monument)
 - Victory in Moscow Rally in USSR, elder son nation on Satan side
(Summit w/ Gorbachev – “Accept religion, believe in God. Abandon Communism, do not shed blood. Establish diplomatic ties with S. Korea.”
“I will help you: Educate 3000 elite young Univ. Students. Become a world peace president.”) → Restoration of Elder Son's Authority representing the Cain sphere
- ii. Restoration of Parent's Authority (Nov 31 – Dec 6, 1991 Summit w/ Kim Il Sung)
 - July 1, 1991 (Chil Il Jeol) Declaration of God's Eternal Blessing
Declaration of Registration of Clan Messiahs & Return to Hometown Providence
 - Visit to N. Korea on Nov 30, 1991. Summit with Kim Il Sung Dec 6
Signifying restoration of Parent's Authority representing Satan's Worldwide Cain sphere, victory of providence to restore kingship

- April 10, 1992 – Establishment of WFWP (Jamshil Stad.)

Lecture tour by True Mother at Universities in S. Korea

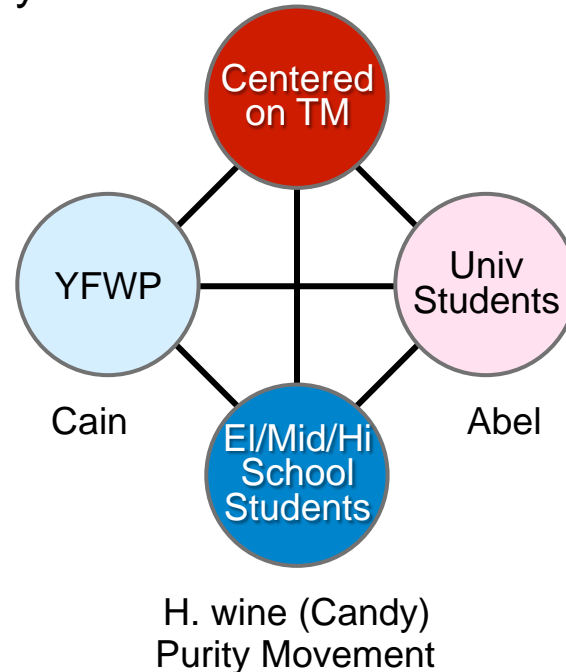

- Declaration of True Parents on the morning of July 3, 1992 (YongSan Segye Ilbo Hall)
- Declaration of the True Parent and CTA at 7:30 pm on Thursday May 13, 1993 (in Manhattan, New York)

iii. Restoration of King's Authority

(2) Proclamation of Heavenly Fatherism (Sep. 1, 1989, Kodiak Alaska)

3) Substantial Manifestation of the True Parents

True Father comes as the second coming of Jesus, who came as the second Adam.

Adam lost his substance at the age of 15.

True Father restored (thru indemnity) the substance at the age of 15, thru Jesus (inheriting the mission)

The second Eve was unable to appear before Jesus, so the Holy Spirit appeared as the spiritual Holy Spirit before the Spiritual Jesus.

Jesus worked in SW while the Holy Spirit worked in the physical world. Accordingly, there has been no standard for the substantial manifestation of the True Mother in the fallen world. The standard exists within God as the Holy Spirit.

For this reason, as the LSA, True Father comes as the substance of the invisible God and is therefore also the substantial expression of the True Mother.

Accordingly, the True Mother must be recreated by True Father within True Father as a True Mother that resembles True Father. In this manner, just as God, who exists as the original body and substance of the Principle, also exists as the unified body of original masculinity and original femininity, True Parents come as the substance of the dual characteristics that resemble the original body and substance of the Principle and therefore must become a unified body. (husband-wife as one self, husband and wife as one body).

True Father must complete, conclude and finalize that mission. Through the substantial True Parents of Heaven, Earth and humankind, God manifests in substance and the realm of liberation and release for God are completed.

4) Start of the CTA centering on the Family

True Father, who is the Messiah, brings True Love (the seed) and the teaching of the Principle.

(1) Principle Teaching (*Wolli wonbon* → *Wolli Haeseol, Wolli Kangnon, Wolli Boncheron*)

(Original Text of the Divine Principle → Explanation of the Divine Principle, Exposition of the Divine Principle, Original Substance of Divine Principle)

(2) Absolute Sex Family Education

(3) Blessing Marriage (International Mass Weddings, World Exchange Blessings)

The Blessing is the liquidation of original sin and changing of the fallen bloodline of Satan by True Parents, resulting in inheritance of God's lineage.

4. Natural Surrender by Satan

1) Ceremony to Proclaim the Dissolution of Indemnity

1 pm, November 1, 1999. Proclaimed at a hotel in Uruguay.

- (1) God established Christianity and prepared for 2000 years for the Lord of the Second Advent. The prepared Christian foundation could not carry out the mission of the bride who attends the Second Coming of the Lord and instead betrayed and disbelieved in him. **The Lord established the Holy Spirit Association for the Unification of World Christianity to stand in place of Christianity and have it carry out the mission of the bride, representing world Christianity.**

Thus, the mission of the church was completed through the 40-year period from May 1, 1954 to May 1, 1994, and a new providential era centering on the family began.

On May 1, 1994 the signboard for the HSA-UWC was taken down and Father proclaimed the Family Federation for World Peace. On that day, the Family Pledge was amended and declared by Father (Hannam Dong House).

- (2) **Beginning from May 1, 1995, a second 40-year providential course was begun**, namely the South American providence centering on Uruguay, which is on the direct opposite side of the globe to South Korea.

- (3) May 1996 - **Dispatch of National Messiahs to 185 nations**

- (4) August 31, 1996. Father conducts a rally for establishing the Family Federation for World Peace and Unification and establishes Mother to hold **the World Rally for Founding and Settlement of the FFWPU** in 43 nations, concluding them by October 31.

In this manner, on the foundation of global victory, True Parents conducted the Ceremony to Proclaim the Dissolution of Indemnity at 1pm on November 1, 1996 in the hotel in Uruguay. The Ceremony to Proclaim the Dissolution of Indemnity held on this day is an important ceremony making it impossible for Satan, who has accused human beings before God for 6000 years, to accuse any more.

2) Natural surrender by Satan

What providence did True Father carry out in order to bring Satan to a natural surrender?

- (1) Declaration of 7.8 Jeol (Chil Pal Jeol) on July 7, 1997

Globalization of the Blessing was planned by True Parents and carried out through the blessed families to achieve the World Blessing. After this, True Father proclaimed Chil Pal Jeol. This day proclaims the restart of God's creation ideal. Thru the global Blessing, True Father recovered the number 7 lost thru the Fall of Adam and Eve, then recovered the number 8 – the number of restart – and proclaimed 7.8 Jeol.

True Father bequeathed the calligraphies **Unified Settlement of the Parent of Heaven and Earth** and **The Realm of Sabbath and Our Ideal Family**.

- (2) October 13, 1997, Hotel in Uruguay – TF bequeaths the calligraphy 'Hoon Dok Hwe'. Blesses humanity to become God's true children and form true families by practicing a life that reads and studies Father's teaching and to **live by Father's teachings** in Cheon Il Guk while attending God and True Parents
- (3) February 6, 1997: Creation of IIFWP (Inter-religious Intl. Federation for World Peace)
Completed Rallies for Establishment in 185 nations by December 31, 2000
- (4) After conducting an important event at 7 am on January 7, 1999 at the Uruguay residence, TF instructed that dissolution of ancestral resentment blessings (ancestor liberation) be conducted (Chung Pyung). He instructed completion of 210 generations by Foundation Day. Before holding the Hawaii Rally on April 9, 2009, TF instructed that all spirit persons who had gone to SW following the fall of Adam return again to earth. Goal: In order to drive out evil in both the physical and spiritual worlds and achieve the world of God's ideal of creation.

- (5) Korean Global Advancement Rally for True Families (Jan 17-25, 1999)
3 generations centered on True Mother conducted the Advancement Rallies for the globalization of True Families (80 cities in 35 nations globally, Feb. 11 – May 29, 1999)
This rally was expanded - 1st expansion: 120 global religious leaders participating
- 2nd expansion: 1,200 Ambassadors for Peace participating
- 3rd expansion: 12,000 partic. Global rallies in 185 nations
- (6) San Paulo Declaration (Absolute faith, absolute love, absolute obedience)
God's creation was achieved through absolute faith, absolute love, and absolute obedience.
Accordingly, for Adam and Eve to grow up, perfectly complete themselves and achieve oneness with God, they must practice absolute faith, absolute love, and absolute obedience.
- (7) Education of the world's blessed families to achieve ideal families (Jardim)
- (8) 40 Day training for National Messiahs of 185 nations. Starting on April 28, attending True Parents, Pantanal fishing event
Must catch 40 fish of 4 species each, for a total 160 fish
- (9) Decided on and proclaimed the Pantanal as the original holy ground (Primal holy ground, root holy ground, victory holy ground)
The Pantanal is an unpolluted region in the original condition that God created it.
- Upon this victorious foundation, **Satan naturally surrendered to True Parents** on March 21, 1999 in the Pantanal. Satan, who tormented God and refused to surrender for 6000 years even though he betrayed God and caused Adam and Eve to fall, finally, for the first time, surrendered naturally to True Parents.

3) Celebratory Rally Proclaiming the Cosmic Victory of TPs

True Parents fought with countless evil forces on earth and in SW and gained victory by applying the principle of restoration thru indemnity to establish the Ceremony for Proclaiming the Dissolution of Indemnity and the natural surrender of Satan. On this foundation, True Parents held the Celebratory Rally Proclaiming the Cosmic Victory of True Parents in the United States, which is the elder son nation, at Belvedere in June of 1999 (Proclaimed in the USA, as the 2nd Rome, representing the 2nd Israel).

On June 14, 1999, True Parents held the Celebratory Rally Proclaiming the Cosmic Victory of True Parents at the at the Seoul Olympic Gymnastic Stadium in South Korea, which is the 3rd Israel nation.

This was the historical day on which True Parents' cosmic victory was proclaimed before heaven and earth.

5. Restoration of God's Royal Authority & the beginning of the Cheon Il Guk Ideal

1) Coronation Ceremony for the Kingship of God (God's Royal Authority)

January 13, 2001 – the Coronation Ceremony for God's Kingly Authority was conducted under True Parents' direction. The year 2001, when God's authority as king was restored, was the beginning of the 3rd 1000 years and marks a new start for God's providence centering on True Parents. After 6000 years since the fall of Adam and Eve, the kingship of God was established and the ideal of Cheon Il Guk began centering on True Parents.

2) Start of the *Cheon Il Guk* Ideal

Proclamation of Cheon Il Guk at noon on True Children's Day, Oct. 1 2001 (Lunar)

The ideal of CIG starts with the establishment of God's authority as king and centering on the blessed families. The CIG era arrives centering on blessed families.

Cheon Il Guk is the country that is created by two people becoming one.

The *Cheon Il Guk* era is the age in which blessed families are globalized.

The World Peace Blessing Ceremony was held on Jan. 27, 2001 at the UN HQ.

Between Feb. 25 and April 17, True Parents conducted Hoon Dok Rallies by touring the US for 50 days, visiting all 50 states at 1 state per day.

3) The Cheon Il Guk Era

(1) On Jan. 6, 2003, on TP birthday, True Parents conducted an event with 2 different meanings.

7 am. Blessing Holy Marriage of the Parents of Heaven and Earth to Open Cheon Il Guk (Father : 83 yrs, Mother : 60 yrs)

9 am. Ceremony to Crown the Parent of Heaven and Earth as King of the Peace and Unification Blessed Families. In this way, the royal authority of the family was established.

(2) July 17, 2003 –True Father named the *Cheon Seong Gyeong* and signed the first volume.

(3) Dec. 23, 2003 - Coronation Ceremony for Jesus' Authority as King conducted at the Jerusalem Peace Park.

(4) Feb. 23, 2004 - Coronation Ceremony for Jesus' Authority as King conducted in the Senate Bldg. at Washington D.C. in USA, which is like the 2nd Rome. Reason: The Kingship Authority of Jesus, who came as the king of kings, must be established prior to establishing the Clan (tribe) and National level kingships.

(5) April 18, 2004 – True Father offers a prayer offering the *Cheon Seong Gyeong* to God.

April 19, 2004 – True Father Proclaims that the Sabbath (7th day week) is to become Ahn Shi Il (8th day week) . Proclaims that the lunar calendar is the Heavenly Calendar.

(6) May 5, 2004 – Proclamation of *Ssanghap Ship Seung Il*. (SHSSI) (Victory of Ten Combining Two Parts)

At the first Ahn Shi Il (following the proclamation of *Ahn Shi Il*) in Yeosu Sea Garden, True Father presided over *kyungbae* and then proclaimed *Ssanghap Shipseung Il* and the passing of the Era Before the Coming of Heaven and the advent of the Era After the Coming of Heaven.

The Era Before Heaven's Arrival was the era of the providence of restoration thru indemnity, but the Era After Heaven's Arrival is the era of the providence of restoration when True Parents do not require indemnity.

After proclaiming SHSSI, True Father spent 85 days fishing in the ocean off Yeosu to represent the 85 years of True Father's life.

He declared that it was a day of blessing for the people of the world, who have the blessing and grace of being born in and living in the same era as True Parents.

(7) August 20, 2004. Blessing Ceremony for the Restoration of National Kingship and Registration into the National-level Cheon Il Guk conducted by True Parents in the Auditorium at the South Korean National Congress Library

After conducting the Coronation Ceremony for Clan Kingship on August 18, 2004, which was held on the foundation of the Coronation Ceremony for the Parents of Heaven and Earth as the King of the Family on Feb. 6, 2003, True Father conducted the Blessing Ceremony for the Restoration of National Kingship and Registration into the National-level Cheon Il Guk at the National Assembly in Seoul.

(8) Sept. 12, 2005. Creation of the Universal (Cosmic) Federation for Peace in Washington

Proclamation of creation of the Abel UN, appointment of Ambassadors for Peace in all nations of the world

Declaration of the elevation of UPF to the position of Abel UN in September, 2007

(9) June 13, 2006. Offering of Coronation Ceremony of the Entrance of the Parents of Heaven and Earth as the King of Cosmic Peace into the Palace

In light of God's authority as King being established, True Parents prepared a substantial palace and conducted a ceremony to attend God in that palace.

During the period between June 6 and June 13, 2006, creation of the World Peace Corps and the World Peace Police

These two forces were created to protect the Blessed Families of the world and create a peaceful world centering on God. During this 8-day period, True Father decided and proclaimed the Cheon Il Guk Anthem, Flag, Bird and Flower. Formulated the 12 tribes centering on the True Children at a ground-breaking ceremony at Kimpo Airport.

6. Proclamation of the Year of Jubilee and the Providence Centering on Hawaii

1) Proclamation of the Year of Jubilee

(1) Proclamation of the providential year of jubilee

On January 1, 2007 True Parents declared a providential year of jubilee.

True Father made an offering prayer on March 9 at King Garden in Hawaii, then carried out the following important providences centering on Hawaii, KG.

i. Dedication of King Garden in Hawaii (March 9, 2007)

After arriving in Hawaii on March 9, True Parents dedicated the True Parents' residence, assigning it the name 'King Garden' and writing a calligraphy. True Father explained that if Adam and Eve had not fallen but perfected themselves, the Garden of Eden would have been 'King Garden'. Father also explained that he would conduct various important providences centering on Hawaii King Garden.

ii. Rally for Proclaiming the Dawn of God's Civilization (Divine Civilization)

On March 17, 2007, holding the Rally Proclaiming the Dawn of God's Civilization, True Father proclaimed the start of the Pacific Rim providence.

Fallen world – the river civilizations centering on the 4 great rivers → Mediterranean peninsula civilization – Atlantic civilization (Britain) – Pacific civilization (USA)

Cain-realm Christian Russian Orthodox – Cain-realm civilization and culture – Communist world

Abel-realm Christian Roman Catholic – Germany, France, settled as Anglican Church centering on Britain.

The Christian Abel-camp civilization & culture centering on the USA – Democratic world

- ◇ Puritan spirit of the USA is disappearing.
(Faith of the early church, the education ideals, ideal of family collapsing)
(Breakdown of young people's ethics, value system, patriotism, sexual morality)
- ◇ Soviet strategy to communize USA, N. Korea's strategy to communize N.E. Asia advancing.
- ◇ TF declares that he has completed his providential responsibility to America via his 34 years of activity centering on the USA, returns to S. Korea to pursue Unification of Korea.
- ◇ Concluding the pacific providence centering on the USA brings about a conclusion of the sphere of civilization centering on Satan.
- ◇ God's Hawaii-centered civilization centers on the Pacific Rim and is started by True Parents.
- ◇ The Pacific Rim providence centering on God starts centering on Hawaii and heavenly fortune comes to the Korean peninsula so that the divine civilization centering on God blossoms and bears fruit as a peninsula culture. S. Korea, the center of the Korean peninsula, where heavenly fortune arrives, becomes the center of the providence and the central nation of the world.
- ◇ The Pacific, where the deepest water on earth is found, is like the mother belly, and the divine civilization starts from Hawaii, which is like the mother's womb.
- ◇ The Rallies Proclaiming the Dawn of God's Civilization began from Hawaii. Further rallies were held in S. Korea and Japan in April, and on May 20, in Washington.

- iii. **Special prayer by True Parents (Summit of Mauna Kea, November 4, 2007)**
 - iv. **Bequeathal of Pyunghwa Hoon Gyung (Peace Message Scripture)**
 November 5, 2007 – TF conducts ceremony to bequeath PHG.
 July 26, 2008 – TF designates the PHG as the *Pyunghwa Shin Gyung* (Divine Scripture of Peace) and includes it in the Eight Great Textbooks.
 (The Peace Message Scripture was completed on November 15 at Geomundo Island. Proclaimed as completed, concluded and finalized on January 8, 2008)
 - v. **Proclamation of the Realm of God's Divine Heart (神心情圈)**
 November 6, 2007 – True Father proclaims the Realm of God's Divine Heart on November 6, 2007, at King Garden Hawaii. Conducts a ceremony proclaiming the perfect completion of the 4th Adam's Realm of heart.
- (2) *Ssanghap Chil Pal* Jubilee Year (Twin Parts Seven Eights Jubilee)**
 January 1, 2008 – True Parents proclaim the Twin Parts Seven Eights Jubilee Year
 The providential year of Jubilee proclaimed in the previous year (Jan 1, 2007) is linked over to the year of 2008, and because the providence is being completed, concluded and finalized, True Father proclaims this as the 2 P 7.8 Jubilee Year.
- i. **January 13, 2008 – Benediction proclaiming the liberation of All Created Things and planting of a commemoration tree**
 - ii. **Start of God's Culture (Divine Culture) (神文化)**
 April 3, 2008 – (Las Vegas) TF proclaims the start of God's Culture.
 Las Vegas is a city where all the evils of Satan are concentrated.
 On this day, which is the anniversary of the Jeju Uprising on April 3, 1948, in Las Vegas, True Parents proclaimed God's Culture, then came to King Garden Hawaii and proclaimed the start of God's Culture.

iii. Event on the 49th True Parents Day

April 6, 2008 – A ceremony was conducted by Mother at King Garden Hawaii according to True Father's instructions.

In this event, True Mother brought together the spirit world and physical world Cains and Abels centering on the True Children and then True Father offered the united True Family to God. This event was the first time in providential history that the restoration thru indemnity that unites the Cains and Abels of the spirit world and physical word centering on the True Children of the True Family was completed, concluded and finalized.

iv. Declaration of the Restoration of the Independence of the Homeland (조국광복)

Return of the Sovereignty of the Homeland (Fatherland) was declared on the foundation of the unity of the Cains and Abels of the spirit world and physical word in Hawaii King Garden.

Final Rally Proclaiming the Return of the Sovereignty of God's Homeland was held in Seoul and TF gave education binding together the Cain and Abel realms.

- ◇ Education of Japan's Mindan (S.K. NGO) & Cho Chong Ryeon (N.K. NGO)
- ◇ Education of Catholic and Protestant leaders from N. and S. America
- ◇ Education to unite Cains and Abels representing the world given to invited leaders from the 3 losing nations and 3 victorious nations in WWI and WWII
- ◇ Education to invited Ambassadors For Peace Clergy centering on S. Korea, Japan and USA

v. Wollu Bonche Ron Education (Original Substance of the Principle)

- ◇ Victory of Resurrection on August 8, 20 days after the Helicopter Accident (Victory of Rebirth) on July 19, 2008
20 days after that, on August 28, Victory of eternal Life. Declaration of complete and actual recovery at noon, 40 days after the accident. Followed by celebratory victory luncheon.
Following an event to commemorate the declaration of Heavenly Fatherism on Sept. 1, True Father announces Wollu Bonche Ron (OSDP) education
- ◇ For 12 days, starting from October 10 until October 21 2008, starting at Hawaii King Garden and then moved to Cheon Jung Gung to finish.
- ◇ Title of Program: “Education for Proclaiming the Perfect Completion of the Realm of Liberation from the Portion of Responsibility in God’s Providential History” (하나님 섭리사의 책임분담 해방권 완성 선포 교육) .
TF instructs that each person should receive Wollu Bonche Ron (OSDP) education 5 times or more.
The education that proclaims this kind of providential will : meaning is called Wollu Bonche Ron (Root and Origin of the Principle – OSDP) .
- ◇ Implementation of touring education of leaders in 6 continents, centering on S. Korea (271 times in the world)
 - N. E. Asia Leaders – in Hong Kong
 - Taiwan Leaders – in Taiwan
 - Korean Leaders – 3600 participants, 30 days education
 - Japanese Leaders - 3600 participants, 30 days education
 - European & Other, centering on USA - 3600 participants, 30 days education
- ◇ TF states that by implementing Wollu Bonche Ron (OSDP) education, the mission of religion is finished and ideological conflict is also finished.
- ◇ By declaring the dawn of God’s (Divine) Civilization through proclaiming the providential Jubilee, the civilization of Satan’s world is come to its end and the Pacific Rim Providence is begun centering on God.

- ◇ Through proclaiming the *Ssanghap Chilpal Jubilee* (2P7.8 Jubilee) the providential jubilee is completed, concluded and finalized.

By implementing *Wolli Bonche Ron* (OSDP) & Absolute Sex Education, Foundation Day could be proclaimed and Cheon Il Guk could begin. In addition, God's World of the Creation Ideal could begin centering on the victorious True Parent of Heaven, Earth and Humankind.

vi. Absolute Sex Education

- ◇ January 1, 2009 – In the new year's motto, True Father proclaims the Realm of Cosmic Sabbath of the Parent of Heaven and Earth, and the victory of the realm of true love, true life and true lineage on the basis of absolute sex.
- ◇ In 2009, 12 years after he first proclaimed the Cosmic Sabbath of the Parent of Heaven and Earth on the establishment of 7.8 Jeol, TF draws and makes clear the conclusions of that announcement.
- ◇ The Realm of the Cosmic Sabbath of the Parent of Heaven and Earth is established on absolute sex, and when true love, true life and true lineage are victorious on that foundation, all of God's purpose is eternally accomplished centering on absolute sex lineage.

Absolute sex education exists because in the texts used up to this time, namely *Wolli Haeseol* (Explanation of the Principle) and *Wolli Kangnon* (Exposition of the Divine Principle), the expression 'Absolute Sex' was not used because the time was not yet ready. Because God's lineage is eternal, it cannot fall in the future and no one can block the realm of God's lineage.

The True Parent completed, concluded and finalized that mission.

In this way, the Realm of the Cosmic Sabbath of the Parent of Heaven and Earth is accomplished on the basis of the Realm of the Absolute Sex Lineage.

(3) Proclamation of the True Parents Holy Wedding Jubilee and Conclusion of the Providence of Restoration

i. Proclamation of the 50th Jubilee of True Parents Holy Wedding

April 11, 2010 (March 16, Lun.) – Golden (50th) Anniversary of True Parents Holy Wedding , TPs proclaim a Jubilee.

Adam and Eve were tempted by Satan, ate the fruit of the K. of good and evil and fell. They were unable to become True Parents and instead become false parents, so that a world of sin was created both on Earth and in SW on the vertical and horizontal 8 stages. Based on the principle of restoration thru indemnity, the True Parent fought with billions of Satans both on Earth and in SW and was victorious, so that on the occasion of the 50th anniversary of True Parents holy wedding, TF proclaimed the True Parents Holy Wedding Jubilee, thereby bringing the providence of restoration to completion, conclusion and finalization.

ii. 60 year since True Father's victorious emergence from Heung Nam Camp

October 14, 2010 marks 60 years since True Father was liberated by UN troops after emerging victorious in the 2 years, 8 months imprisonment at Heung Nam Forced Labor Concentration Camp.

Thru these 60 years, by application of the principle of the providence of restoration, True Father victoriously completed, concluded and finalized complete restoration thru indemnity of the 6000 years of sinful history since Adam and Eve fell and became false parents.

iii. Proclamation of Year One of the Heavenly Calendar and Declaration of Foundation Day

January 1, 2010 - Proclamation of Year One of the Heavenly Calendar.

True Father declares that Ki Won Jeol (Foundation Day) will be held on Jan. 13, 2013, 12 years after the TF established God's Royal Authority as King on Jan. 13 2001.

2) The Pacific Rim Providence Centering on Hawaii

The Pacific, which is home to the deepest waters on Earth, is like the mother's womb, and the Asian and North American continents are twins, like Cain and Abel, within the mother's womb.

- ◇ The True Parent explained that a tunnel must be built through the Bering Straight to bring the two divided continents together.
- ◇ In Adam's family centered on Satan, God conducted the providence of dividing Cain and Abel. However, God's providence centering on True parents starts from uniting Cain and Abel for the sake of the ideal world of the God's original creation.
- ◇ Hawaii, which is located at the center of the Pacific Ocean, is like a mother's womb. Centering on this womb-like Hawaii, God's providence God's civilization begins for the first time in human history. The Pacific Rim civilization that centers on God starts centering on the True Parents.
- ◇ True Parents prayed at the summit of Manua Kea, the highest point in Hawaii, on November 4, 2007 to conclude the providence that centers on Hawaii, then relocated the providence to Las Vegas in the US state of Nevada.

7. The Providence Centering on Las Vegas

In Las Vegas, which concentrates all the substance of the Satanic World, True Parents decided on and proclaimed certain matters that are very important in terms of the providence.

1) Coronation Ceremony for Realm of Liberation of God, the King of Kings

At the end of December, 2008, in Las Vegas, True Parents announced that they would offer the Coronation Ceremony for Realm of Liberation of God, the King of Kings, and instructed that the event be held in S. Korea on January 31, 2009, the anniversary of True Parents birthday.

However, suddenly, they brought the schedule forward and conducted the ceremony at 11 am on January 15 at Cheon Jung Gung.

On the afternoon of that day, North Korea's Kim Jung Il publicly announced Kim Jung Eun as his successor.

Up until this event was held, God recognized the satanic world sovereignties of Cain and Abel, divided by the fall, but after the Coronation Ceremony for Realm of Liberation of God, the King of Kings, was held, he cannot recognize or acknowledge the Cain and Abel sovereignties of the satanic world.

Only the sovereignty of God, the King of Kings, is recognized. This is the day of the ceremony for the coronation of Hyung Jin Nim and the day of the ceremony in which True Parents bequeathed to him True Parents' teachings.

2) South Korea is God's Fatherland and Homeland

Every person has a homeland, and an ancestral fatherland. The Creator, God, however, does not. By True Parents offering to God the Coronation Ceremony for Realm of Liberation of God, the King of Kings, and declaring South Korea as God's homeland and fatherland, finally God's homeland and ancestral fatherland could come into existence.

3) Cosmic Rally for Proclaiming the Substantial Word of the Settlement of the True Parent of Heaven, Earth and Humankind

Offering the Coronation Ceremony for the Realm of Liberation of God, the K. of Ks

After proclaiming the homeland and ancestral fatherland of God, TP decided on the 'Cosmic Rally for Proclaiming the Substantial Word of the Settlement of the True Parents of Heaven, Earth and Humankind' in Las Vegas. The Rallies were held starting from S. Korea, after which they travelled to Europe, the birthplace of Western Christianity, and TPs toured the central Christian nations and held proclamation rallies. After gathering together all the victorious conditions set there, they returned once again to Las Vegas, the place where all the fruits of Satan's world are concentrated, and proclaimed to the cosmos that God is victorious centering on the True Parents.

By being victorious in the Cosmic Rallies for Proclaiming the Substantial Word of the Settlement of the True Parents of Heaven, Earth and Humankind, they bequeathed the 8 Great Textbooks (which are like the True Parent's final will) so that all humankind might live as God's children.

4) Special Proclamation by the True Parents of Heaven, Earth & Humankind

2:20 am on May 8, 2010 & 3:25 am on May 15, 2010. A special proclamation was made by True Parents centering on God over two consecutive instances.

- (1) Proclamation and offering of the Era of Full Transcendence, Full Imminence, Full Authority and Omnipotence on the standard of the Completion, Conclusion and Finalization after True Parents Couple have achieved the Final Oneness.
- (2) Proclamation of the handing over to S. Korea of the ceremony for the victory of the 1st, 2nd and 3rd Israels for the conclusion of the Rebirth & Resurrection Sung Hwa Ceremony (Eternal Life) during the time of the life course.

Thus, South Korea becomes God's homeland and ancestral fatherland.

By announcing S. Korea as God's ancestral fatherland, the Cosmic Rallies for Proclaiming the Substantial Word of the Settlement of the True Parents of Heaven, Earth and Humankind are also brought to perfect completion in S. Korea.

As a result, the borders within the cosmos are erased.

On that foundation, at Cheon Jung Gung in South Korea, God's ancestral homeland, True Parents proclaim the perfect completion, conclusion and finalization of God's providence of restoration, and the perfect completion of *malsseum hoon dok hwe* (Hoon Dok meetings centering on the Word) and the perfect completion of unity between God and True Parents.

The teaching (Word) that True Parents especially declared in Las Vegas, where the fruits (실체상) of Satan's world are concentrated, were proclaimed as perfectly completed in South Korea.

8. Foundation Day (*Ki Won Jeol*)

Foundation Day was proclaimed for January 13, 2013 on the foundation of the Wollibonche Ron (OSDP) education that began from Hawaii King Garden.

The theme of the WBR education is the Proclamation of the Perfect Completion of the Realm of Liberation from the Portion of Responsibility in God's Providential History, and this leads to the proclamation of Foundation Day.

True Father gained internal victory on January 13, 2012, which is the start of the 3rd year counting from the day of declaration of Foundation Day (January 13, 2010), the day on the completion of the 3rd year, January 13, 2013, was the day to externally proclaim that internal victory before the cosmos.

In this way, Foundation Day is the day that True Parents would be completely victorious, internally and externally.

1) The Meaning of Foundation Day

(1) Holy Wedding of God (Manifestation of the Substantial God)

(2) Bequeathal of the Royal Seal of God, the King of Kings

The Parent of Heaven, Earth and Humankind, who was to inherit God's royal seal on Foundation Day, would become the substantial king of kings on Earth and in Heaven by attending the invisible king, God (Hananim), resulting in the foundation year of Cheon Il Guk.

(3) Registration of Blessed Families into Cheon Il Guk

As the day in which all blessed families in the world were to be registered into Cheon Il Guk together with the True Parents, Foundation Day is also the day when the gate of entry into Cheon Il Guk is opened by the victorious True Parents of Heaven, Earth and Humankind.

2) Perfect Completion of the Realms of God's Liberation Release

(1) Adam is both the Son of God and also God's body.

Eve is both the Daughter of God and also Adam's bride.

When Adam and Eve are perfectly completed, they become the true parents.

This is God's Ideal of Creation. However, because of the fall, Adam was unable to become perfectly complete, became the false parent and lost the ideal of creation.

The person who comes to recover the qualification of the true parent is True Father.

(2) Perfect Completion of the Realms of God's Liberation and Release

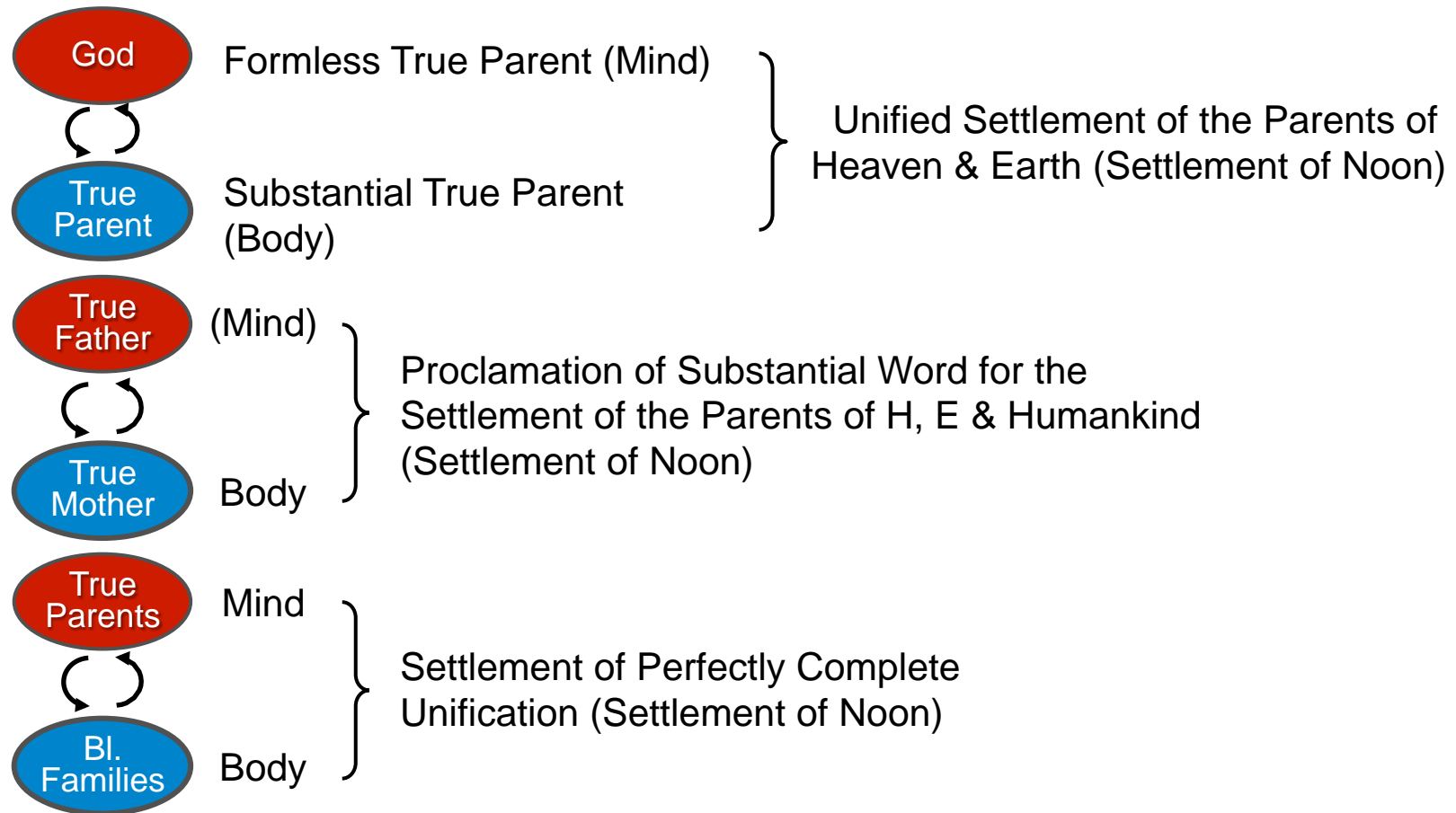

Perfect Completion of the Realms of God's Liberation and Release
 Completion, conclusion and finalization of the Final Unity of True Parents (F&M) Full
 Transcendence, Imminence, Authority and Omnipotence
 Unification of Freedom, Equality, Peace and Blessing – The Era of Great Peace

TP Oek Mansei!

3) Era of the Return (回歸時代) → Foundation Day

4) Era of the Providence

9. The Law of the Eight Stages of the Providence of Restoration

1) Providence of the Restoration of Eight Vertical Stages

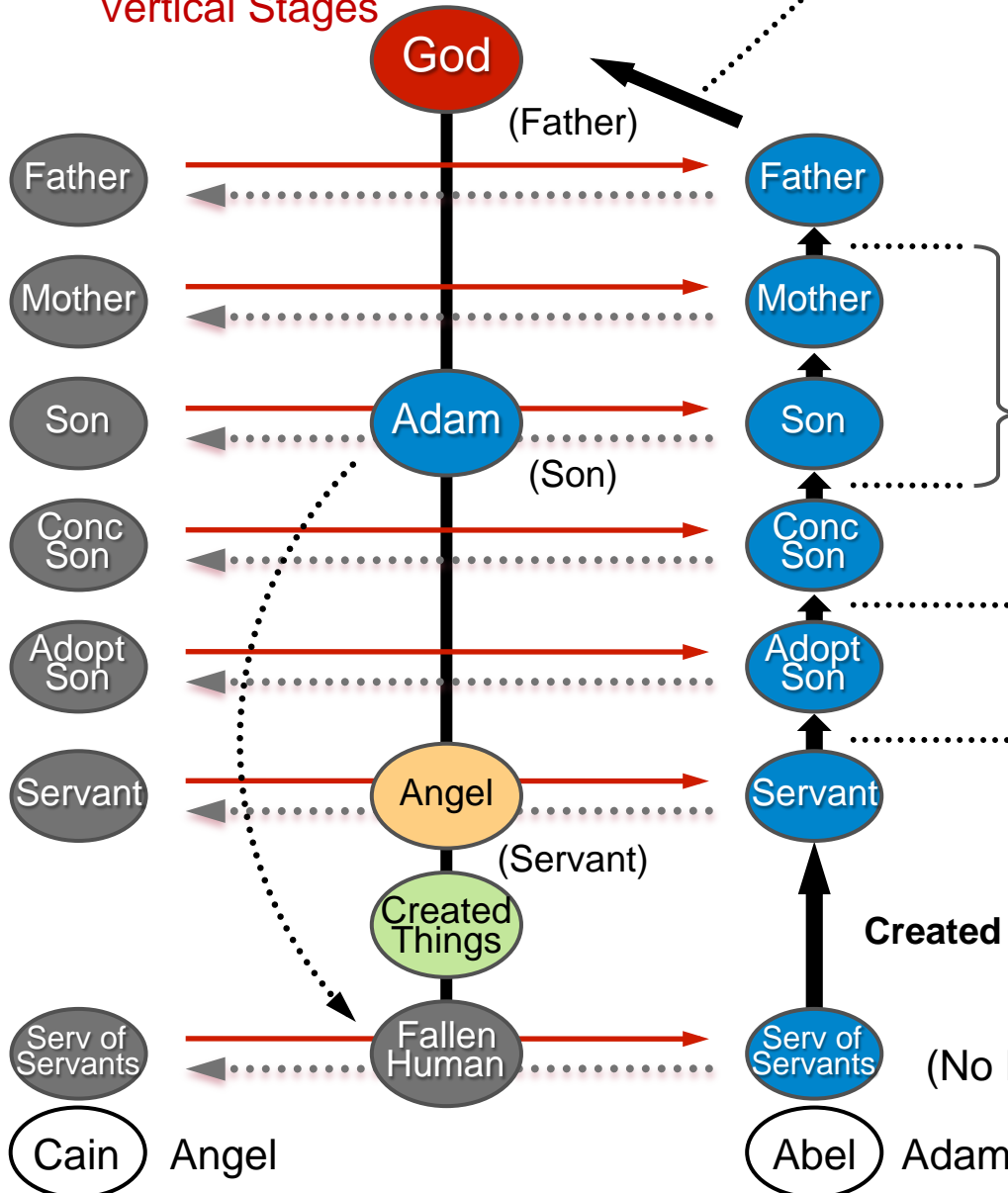

Completed, concluded and finalized Final Oneness of both True Parents

- viii. Proclamation of the Substantial Word for the Settlement of the True Parents of Heaven, Earth and Humankind
- vii. S. Korea is God's Ancestral Fatherland and Homeland.♪
- vi. Coronation Ceremony for Realm of Liberation of God, the King of Kings
- v. Coronation Ceremony of the Entrance into the CJG Palace
- iv. Coronation Ceremony of the King of Cosmic Peace
- iii. Ceremony to Crown the Parent of Heaven and Earth as **King of the Peace and Unification Blessed Families**
- ii. Blessing Holy Marriage of the Parents of Heaven and Earth to Open Cheon Il Guk
- i. **Coronation for God's Authority**

Comp. Testament Era (Holy Wedding of the Parents)

New Testament Era (Son)

Old Testament Era (Creation)

Created things (representing the Word)

Conc.Son = Son w/
a Concubine

(No Lord or master)†

Adopt. Son =
Adopted son

2) Providence of the Restoration of Eight Horizontal Stages

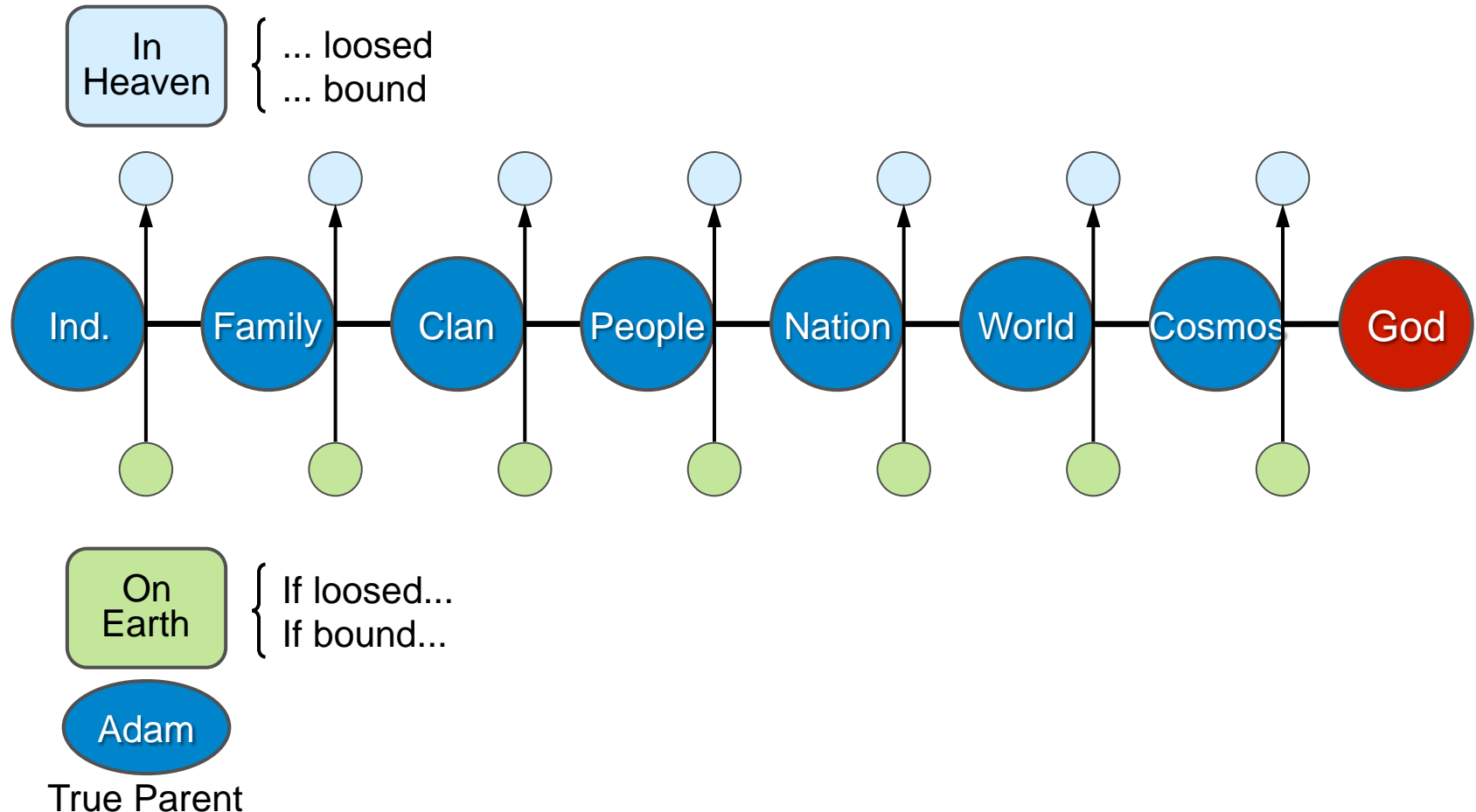

10. Realization of the Ideal World as it was Originally Created to Be

1) Evil Forces to be Driven out from Earth and SW

(1) Ceremony for Liberation of Ancestral Grievances

Ceremonies for the liberation of grievances and blessing of ancestors performed in the physical world. After conducting the God's Day events in Uruguay on January 1, 1999, TPs conducted a special event at 7 am on January 7 and gave the instructions to Chung Pyung to perform liberation of grievances for ancestors starting from that day.

Instruction for all families to accomplish ancestral liberation and blessing for 210 generations before Foundation Day

- Ancestors who receive grievance liberation and the Blessing are to return to the physical world so that the evil spirit world is dissipated and the good spirit world of the original creation is opened up.

(2) Spiritual Work of Returning Resurrection on Earth

- Blessed families are to become Divine Clan (Tribal) Messiahs and after educating their descendants and clan in *Wolli Boncheron* and the absolute sex teaching, bless them and guide them to do *hoon dok* at home. In this way, blessed families should bring their ancestors who have returned from SW and all the members of their earthly clan to become God's children and together drive out, from both the SW and the PW, the evil forces that center on Satan, thus accomplishing the world of God's creation ideal.

2) The Scope of Indemnity Proclaimed by the True Parent

- Adam and Eve fell, thereby becoming false parents and creating a world of immorality and lies centering on Satan, both in the Physical World and in the Spiritual World. Establishing the law of indemnity, True Parents drive out the forces of evil from PW and SW and achieve the ideal world of Cheon Il Guk.
- Because Adam and Eve fell in the physical world, the True Parent is able to discover the Principle and establish the law of indemnity and restore things in the physical world, but in the spiritual world, there is no law of indemnity. In the spiritual world, only the law of the principle created by God, who is the root and source (*bonche*) of the Principle, exist. For this reason, it is not possible to erase one's sins in the spiritual world, and they must be erased on Earth (the physical world).
- While he is on Earth, the True Parent establishes all the laws of indemnity to allow for the liberation of Heaven and Earth, the liberation of God, and the liberation of humankind, and open the way for forgiveness in both the physical world and the spiritual world (in all vertical and horizontal 8 stages).
Therefore, even though True Father resides in the spiritual world, he is able to disseminate the grace of forgiveness that even God himself cannot disseminate.
- Residing in the spiritual world, True Father is able to digest and sort out the Satanic World through the path of indemnity that he opened up in the spiritual and physical worlds while he was on earth, and is therefore able to realize the ideal world of original creation desired by God.

3) The Mission of Divine Clan Messiahs

- As Divine Clan Messiahs, the blessed families who live in the physical world must bless their own clans in the spirit world and physical world in the place of the victorious True Parents.

This is the reason that True Parents instructed that ancestral liberation of grievances (*hae won*) and blessings must be conducted up to 210 generations.

- The mission of divine clan (tribal) messiahs is to complete the mission of family *hoon dok* churches by educating their extended family (clan) in *wolli bonche ron* (Teaching of the Root and Origin of the Principle) and the absolute sex teaching, blessing them and restoring them to attend God and the True Parents of Heaven, Earth, and Humankind in their own family, so that they can become God's true children through reading and studying God's word.

In this manner, they must realize *Cheon Il Guk*, which is the ideal world, through *Hoon Dok* family churches.

4) Creation of the Women's Abel United Nations

- July 16, 2012 - Creation of the Women's Abel UN (Chungshim Peace World Center)

TP created the Women's Abel UN to digest the women of the world, who form roughly half of the fallen world's population of 7 billion human beings, on the global level and to ally with the Abel UN that is centered on men to carry out the *wolli bonche ron* & absolute sex education of humankind . By attending God and the True Parents of H, E and H, and realizing the ideal world of *Cheon Il Guk*, which God and humankind have always longed for, they should achieve the *Tae Pyung Sung Dae* ideal world of true freedom, equality, peace and happiness and establish the True Parent UN.

- The entire life course of the True Parent is the 8 Great Textbooks bequeathed to us.

The fact that the True Parent established the 8 Great Textbooks, which is equivalent to the last will and testament of the True Parent's entire life, means that True Parents were able to complete all their purpose. The True Parent created the 8 Great Textbooks so that humankind could live as God's children for eternity.

The Eight Great Textbooks:

True Father's Speeches Collection, *Wolli Kangnon* (EDP) , CSG, the Family Pledge, *Pyung Hwa Shin Gyung* (Peace Messages) , "True Family that opens the door to Heaven", "Owner of Peace, Owner of lineage", World Scripture

In addition, True Father instructed us to read True Father's *Autobiography*.

- The True Parent bequeathed to us all everything he achieved, all his victories, accomplished through blood, sweat and tears over the course of his life.
- We shall become true children that resemble the lineage and victorious tradition of the True Parents of H, E and H, attend True Parents, return joy and glory forever in Cheon Il Guk and live happily.

11. Lessons learned from the Life of the True Parent

1) Principled Life & Practice

(1) Human portion of responsibility

(2) Guidelines for life

i. Become the master of yourself before desiring to be master over the universe (govern your desires for food, sleep and sex).

ii. Become a true person.

The source and origin of 'that which is true' is God, the content of that which is true is 'that which is liked'.

2) Victorious Life & Practice

(1) Love your enemy.

The standard that determines victory or defeat between God and Satan is loving the enemy.

(2) Live by the law of the Principle.

(3) Do not tell lies, and do not make excuses.

(4) Do not worry, and invest all your sincere effort and devotion.

3) Hoon Dok Life & Practice

- (1) Become the substance (the embodiment) of God's word.
- (2) Throw off the clothing of the fallen world, seek the center and attend it.
- (3) Hoondok Family Church

Wolli boncheron absolute sex teaching, the Blessing, *hoondok* life practice

4) The Three Ironclad Rules and the Three Primary Judgments

(1) The Three Ironclad Rules

- i. Preservation of Lineage (Purity/Chastity)
- ii. Prohibition from Violation of Human Rights
- iii. Prohibition from Plundering Public Funds

(2) The Three Primary Judgments

- i. The Judgment of Character = Love
- ii. The Judgment of Meritorious Service = Public Life (human beings are public beings)
- iii. The Judgment of Public Funds = All things are public things

CONCLUSION

Let us live according to God's word to create a life and practice that exists for the sake of absolute sex, the importance of lineage, true love, and the spiritual world.

II. The Final Prayer of the True Parent

Today, I have made the final perfect completion and finalization and offered that to you, my Father.

Father, I know that I have offered to you my entire life, and in accordance with that will, I have now come to the time to conclude, with devotion, all my life.

Now, we are able to return to the original Garden of Eden in which no Fall has taken place, where we are now able to transcend all the circumstances where Eve was corrupted and Adam became compromised by his portion of responsibility.

With the authority of the liberation and release of all things, I proclaim that anyone, as long as they follow the True Parent, in the 4th dimension, even in the 14th dimension, if the clan messiahs, centering on the 14 sons and daughters and the 4th dimension registration that can adopt to Heaven that which leads to hell, achieve a status that can represent the nation and restore the 387 countries (Abel UN sphere 194 nations, Cain UN sphere 193 nations), all will be finished.

I have accomplished everything necessary to achieve that task. Aju!
(August 13, 2012)

III. Sunghwa of the True Father of Heaven, Earth and Humankind

- 1) True Father ascends at 93 years of age (September 3, 2012 1:54 am).
- 2) Before he ascended, True Father perfectly completed, concluded and finalized the providence of restoration, such that he prayed 'It's all done. It's all done.'

He then emphasized that what remains is the mission of clan messiahs, and blessed the future, saying, 'My fatherland, shine forth! Fatherland shine forth! Fatherland shine forth!' before he ascended.

- End -

God's Providence of Restoration

1. God's Providence of Restoration

- 1) God's Providence of Restoration has taken 6000 years to Restore Fallen Human Beings.

God created Adam and Eve as his son and daughter in the Garden of Eden. However, during her growing period, Eve disbelieved in the Word of God and sinned, falling with the archangel.

Adam was unable to fulfill his responsibility and became the child of Satan. Adam eventually became a false parent centering on Satan and formed a false family, giving rise to a Satanic world, by forming a nation, world, and cosmos centered on Satan.

- 2) The Center of the Providence of Restoration is the Appearance of God's Son, the Messiah.

The providence of restoration is divided into 3 eras, namely the Old, New and Completed Testament eras.

After the providence passes through the Era of the Foundation for the Providence of Restoration, the Era of the Providence of Restoration and the Era of Extending the Providence of Restoration, the Lord at the Second Coming must come and complete, conclude and finalize the eras of the providence of restoration through indemnity.

He must liberate God, completely liberate humankind in both the physical and spiritual planes, liberate fallen Adam and Eve and even the fallen angel who became Satan, and accomplish an eternal world of true love, free from evil forces in both the physical and spiritual planes, as was originally intended in God's original creation.

3) The Mission of the Messiah

The messiah comes in the capacity of God's son.

The messiah is the seed of true love.

Finds the Principle, lives the Principle and perfects the substance of God's word

Precisely and accurately, reveals and teaches who God is. Guides humanity in their relationship with God. Must elucidate the true nature of Satan and the root of sin

Must bring Satan to a natural surrender

Must complete, finalize and conclude the providence for restoration through indemnity

Liquidates the original sin of fallen human beings, confers on them the Marriage Blessing and guides them to realize true families

Perfection, finalization and completion of the realm of God's liberation

The substantial True Parent is the substantial God.

2. The Providence of God

- 1) Era of the Providence of Restoration through Indemnity (Era before the coming of Heaven)
- 2) Era of the Providence of Restoration (Era after the coming of Heaven)
- 3) Era of Period of Return (회기시대) (Era when Adam and Eve return to the state they were in immediately prior to the fall)
- 4) Foundation Day (기원절) (Marriage of God, transfer of the Royal Seal, blessed families registered in *Cheon Il Guk*)
- 5) Era of Providence (God rules over *Cheon Il Guk* using the body of the True Parent)

The Content (Substance) of God's Providence

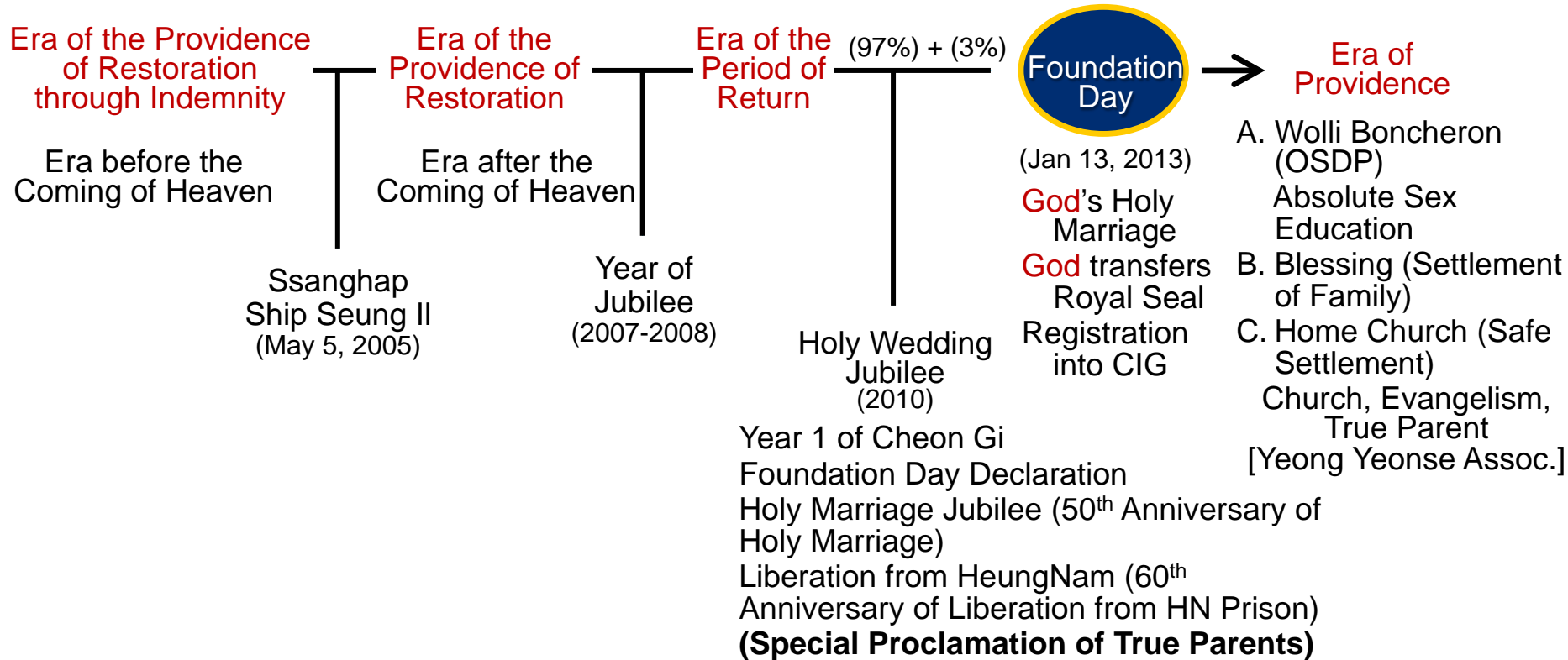

3. The Birth of True Father

- 1) "The Lord does not come as the bridegroom – he comes as the father." (CSS 10 p. 171-172). In the Bible (Matt 16:27) it says the the Son of Man will come in the glory of his father. Father came in the capacity of the True Parent (CSS 208-77).
- 2) God's providence for the birth of the True Father, who is the Messiah
 - (1) True Father's birth from the perspective of the providence of restoration 400 years of the Era for the Preparation for the Second Coming of Christ 1917 is 400 years from 1517, the year of start of the Reformation led by Luther.

(2) Providence of National Restoration through Indemnity to Allow the Messiah to be Born

The Three Blessings restored by Jesus through victory in the Three Temptations

The Three Temptations of Jesus restored thru indemnity by the three world wars

Victory over 1st Temptation of Jesus – Victorious foundation for restoration of the First Blessing – Messiah is conceived

November 1918 - First World War concluded

February 8, 1919 - Korean Independence Movement instigated by Korean students in Japan – Failed, but movement shifted to Korea

March 1, 1919 (Solar) – Declaration of Independence by 33 representatives at the Pagoda Park in Seoul (Chang Jae Ryeong)

March 1, 1919 (Lunar) – Independence movement led by Yu Gwan Soon (15 years old) at the A-u market place in Chungnam Province

Centering on these dates of March 1919 (both solar and lunar), a condition was set that the sovereignty, people and land of Korea was established, even if it was only for a short moment, and despite the domination of the Japanese Empire, the Messiah was conceived and then born on January 6, 1920.

(3) Family Restoration through Indemnity to Allow the Messiah to be Born

i. The generations restored on the family level through indemnity

Family of patriots – Moon Chi Kook, Moon Shin Kook, Moon Yun Kook (Pastor, authored the March 1st Declaration of Independence)

Absolute level of Mother-Son cooperation centering on Choong Mo Nim (clothes and food in prison, while student)

Absolute level of sibling cooperation centering on Dae Hyeong Nim (completely one) – restoration of elder sonship

ii. For 3 years prior to Father's birth, a golden bird would sit and sing daily in the noganji tree in the family courtyard (auspicious omen). After Father was born, the golden bird disappeared.

- iii. The family experienced an unimaginable level of indemnity.
The house chimney collapsed and broke the dog's back.
The family pig fell down the well and died there.
So many anonymous incidents occurred, trouble caused by Satan filled every possible space.
Sparks escaping from the kitchen fireplace floated around and caused fires.
Father's elder sister was married but became ill and died when she moved to the husband's house.
Elder brother became mentally disturbed, killing the younger sibling whom he loved.
Father's grandfather and uncle both died while abroad.
The family assets were all sold and donated to fund the independence movement (Moon Yun Kook).
- iv. Father's words:
Grandfather testified to Father – that he would be a great man in the future.
Father explained that when he was young, Choong Mo Nim said many things about him and his future.
From a young age, Father had a clear sense of what things would happen in the future. If he said that such and such a thing would happen in such and such a village, it would happen just as he said.
From the age of seven, he matched many couples by looking at their photos.
Father's personality is like fire. He explained that the most difficult thing for him, far more difficult than the torture he endured, was overcoming the impulses of his own fiery, hot-tempered character.

- v. Father's personality is such that he cannot bear to see injustice.

Also, he cannot stand to lose.

Father explained that in order to defeat wrestling opponents much older than he, he stripped the tree behind his house of its bark and practiced wrestling against it every day.

On one occasion, a much older boy beat Father and made his nose bleed. Saying that they would burn down their own house, the boy and his parents came out and begged on their knees for Father to forgive them.

Personality that sees something to the very end once he commits

Hunting the weasel in winter. Chased it all through the night, eventually catching it the next morning at a nearby village.

- vi. Father enjoyed a close relationship with nature and had a profound prayer life.

At 15 years of age (17 April, 1935), on Easter Sunday morning, when he was praying, Jesus approached Father and passionately asked Father to complete the work that he himself was unable to complete while on earth.

Father declined Jesus' request several times, but on each occasion, he perceived a great sorrow in God's heart and instead determined to walk the path of the Will.

Up until 15 years of age, Adam had not fallen and lived without original sin. But due to his fall, Adam lost the substantial body which God could have used as his temple.

At age 15, Father 'recovered' the substantial body and started on the path of the original creation. At that time, he began his course based on the principles of absolute sex.

- vii. Father became directly involved in the independence movement for Korea while in Tokyo, the very heart of the enemy nation, Japan. Here, he had to overcome the trials of temptations from the most beautiful women.

Father was victorious over the trials through a seven year course that lasted until he was 22 years of age. At that time, God blessed Father and entrusted him to be responsible for all the women of humankind.

God instructed Father to protect, raise and bless all women as if they were his own daughters and younger sisters. Based on the foundation of this victory by Father, Mother was born.

(Mother is 23 years younger than Father)

Father walked the path of indemnity (because Christianity failed to believe).

Father explained that in the last days archangel-type religions and Eve-type religions would appear. Why? Because the archangel and Eve fell in the Garden of Eden.

This is why in Korea there appeared spiritual groups centering on men and spiritual groups centering on women.

In the east, it was men – Baek Nam Jun, Lee Yong Do, Kim Baek Mun

In the west, it was women – Kim Seong Do (*Seongju Kyohwe*), Heo Ho Bin (*Inside Belly Church*), Pak Eul Ryo (*God's Wife*)

- viii. Marriage with Song Jin's mother

Song Jin was born on March 1, 1946.

June 6, 1946 – While on his way to buy rice for Song Jin's mother, received a command from God. God instructed Father to immediately search for 'God's wife' without delay.

Immediately, Father found a single Bible and headed north and began preaching in Kyeong Chang Ri village.

4. Father's Life in Prison

- 1) Imprisonment at the Daedong Police Station, Pyeongyang (arrested as a spy for Syngman Rhee, and for preaching)

In prison, Father came into contact with the leadership of the Inside Belly Church (Bok Chung Kyo-hwe).

Father sent a secret message on a slip of paper to Heo Ho Bin, the founder of the Inside Belly Church through disciples of the church who were being held in the same room as Father. Mistakes were made in the process of conveying this message, and Father underwent severe torture as a result (torture that led him to the brink of death).

- 2) Victory of Life in Prison as an Ideological Prisoner for 2 Years 8 Months after receiving a Sentence of 5 Years at the Heungnam Forced Labor Camp

Details of this victory – Had to avoid any condition that Satan could accuse and thoroughly adhere to God's principle life practice in order to gain victory

Father's team (10 men) was responsible to pack 1300 straw bags with fertilizer each day. After ensuring that this responsibility was fulfilled, Father stepped in to help other prisoners with their responsibilities. This was Father's life.

When Jesus walked the way of the crucifixion, he declared that he would return again. In order to restore through indemnity the disbelief of Jesus' disciples and the disbelief of Judaism, Father evangelized and was recognized by devout Christians (12 disciples) during this period.

Once Father gained victory in completing his responsibility, United Nations troops pushed northward and Father was liberated from prison.

3) Walking to Pyeongyang after Leaving Prison

On his way to Pyeongyang Father passed by his hometown of Chongju. However, he was unable to go to his hometown, as this was a time period to indemnify Jesus' own course.

Father had to restore through indemnity the shimjung of Jesus, who could not receive the love of his parents and the love of his brothers and sisters. In this period, Father had to comfort the heart of Jesus.

After he arrived in Pyeongyang, Father passed a period of 40 days searching for his former disciples. Finally, at the very end of this period, he found one disciple who had refrained from heading south in the retreat (Jeong Hwa Park). Father ended up carrying Park south on a bicycle, and later on his back, to cross the 38th parallel line.

When finally crossing over the 38th parallel, Father placed one foot on each side of the parallel and prayed, and then crossed over to the South. After walking and walking, Father finally passed over the Mungyeong mountain pass and in Ulsan City was able to get on a freight train to arrive at Choryang Train Station in Pusan on January 27, 1951.

In Pusan, Father met a friend from his days as a student in Japan, Deokmun Ohm, and stayed on Yeongdo Island in the Pusan area for a short time, working at the Pusan wharves for 3 months.

Later, Father constructed a mud-walled hut in the Bonnekol area, dug a well and wrote the *wolli wonbon* (Original Manuscript of the Principle) over one year, starting on May 10, 1951 and completing the work on May 11, 1952. During 1953, he evangelized and taught the Principle to others, moving from Pusan to Deagu to Seoul. In Seoul, he put up the signboard founding the Holy Spirit Association for the Unification of World Christianity in Bukak Dong (May 1, 1954). Father established a church that could complete the mission of Christianity, which was to be a bride to the coming Lord, and seven years later on April 11, 1960 (March 16 by the lunar calendar), he chose Hak Ja Han and wedded with her in holy marriage.

5. Birth of True Mother

Through three generations of only daughters (Cho Won Mo, Hong Soon Ae, Han Hak Ja) conditions for Satan's accusation were removed. At age 16, she was selected by Father and after completing a special ceremony whereby Father removed her original sin, was blessed in the Holy Marriage of True Parents with Father as per the original creation.

1) The Principle Path and the Principle Mission of the True Mother

(1) The principle path that Mother must walk centering on True Father

- i. True Father (40 years of age) = son - true older brother - true groom - true husband - true father – true grandfather

Mother (16 years of age) = daughter – younger sister – bride – wife – mother – true mother

(May 8, 2010)
2:20 AM

{ True Father
} True Mother

True Parents → Cham Hananim (True God)

ii. Daughter — Daughter In Law — Wife — Mother — Grand Mother — Queen Consort — Wife Of True Parent — Wife of **God**

|| || || || || || ||

Son's Wife — Me — Father — Grand Father — King — True Parent — Hanamin (God)

(2) The Principle Mission of the True Mother

- i. Absolute oneness with the True Father (Settlement of High Noon) – Absolute faith, absolute love, absolute obedience
- ii. Love the True Children absolutely (oneness) – absolutely love God’s lineage as much as God loves his lineage
- iii. Love Cain absolutely (Song Jin Nim and Song Jin Nim’s family, who represent the Cain sphere)
- iv. Love the families of the great saints (love the wives who are part of the families of the six great saints) – become one
- v. Accomplish and complete the liberation and release of the historical *han* of women (painful unresolved anguish of women) that resulted from Eve’s mistake

The *han* of all the women of humanity. The historical *han* of women must be resolved within True Father. Cannot have tears of resentment or complaint, cannot vent one’s own grudge, resentment or spite

(3) In order for Mother to go forward to the position of True Mother, she must be recreated as the True Mother inside of the True Father, by the True Father, and resembling the True Father (CSS 498-130, 585-184).

Mother was selected as the representative of humankind on earth by True Father, who comes in the capacity of the Second Coming of Christ, the Messiah, and participated in the holy marriage ceremony after participating in a special ceremony to liquidate her original sin (pledging ceremony).

Humanity receives the Blessing by the agency of the True Parents.

（ Pledging Ceremony – Ceremony for restoring (the) parents in (of) the fallen realm
Holy Marriage Ceremony – The Ceremony of the True Parents as it was originally created to be ）

Father was not selected or chosen by Mother. Father selected Mother after calling her in (as a young girl) and interviewing her (asking questions and getting her answers).

(4) Mother's Words

- i. She did not learn anything from Father.

True Father's words about how he educated and raised Mother:

Collection of Selected Speeches { Vol. 498 pg. 130 (June 4, 2005), Vol. 537 pgs. 190-191
Vol. 585 pg. 184 (Jan. 30, 2008)

Father explained that he worked his entire life to raise Mother in a way unblemished by the fallen world so that he could dedicate and offer her to God.

- ii. Was Father born with original sin while Mother was born as the Only Begotten Daughter without original sin?

What would it mean if Father began his mission as the Messiah and became the only begotten son only after meeting with Jesus at 15 years of age?

January 6, 1920 would not be Holy Birthday of the True Parent. Instead it would be Mother's birthday. If Father became the Messiah when he met Jesus on Easter Sunday morning on April 17, 1935, then this would be the Holy Birthday of the True Father, the Messiah. Is this kind of assertion or conclusion consistent with Principle? In fact, it's wrong.

God created Adam and created Eve as Adam's partner and spouse by taking one of Adam's ribs (Genesis 2:22) (CSS Vol. 29, pg. 271).

Eve cannot be created unless Adam is created first.

- iii. Mother said that she did not have original sin because she was born as the only daughter of 3 generations of only daughters.

“Two thousand years ago, Jesus, who came as the only begotten son, was unable to meet the only begotten daughter, and so he died. Accordingly, the 2000 years of Christian history has been God’s providence to send the only begotten daughter. After 6000 years, God has finally met the only begotten daughter. That only begotten daughter is me.”

In addition, Mother said that the reason why South Korea is called South Korea (*Han Kook* – ‘the Country of the great Han people’) is because it exists as a country so that the Mother Han Hak Ja, the Only Begotten Daughter, could be sent to earth. But this assertion is not in alignment with the Principle, nor is this God’s providential perspective.

Moreover, saying all these things, Mother also says that no one knew this until now, and that Mother herself is the one who found this out and is revealing this to us, asserting that what she is saying are the secrets of Heaven and a new revealing of truth.

- iv. The assertions that True Father’s original sin was removed when he met Mother, or that Mother was born as the Only Begotten Daughter without original sin after 6000 years of history – these assertions are mistaken and are not in accordance with the Principle.

Mother says that she learned nothing from Father but was born knowing everything. But this statement was made by Mother in ignorance of the human portion of responsibility. Accordingly, Mother is declaring that she does not accurately understand the Principle (CSS Vol. 608 pgs. 40-42).

Mother is saying that Father was born with original sin and that he became the Messiah by meeting Jesus at the age of 15 and inheriting his mission. To say that Father was born with original sin is a more fearful and terrible sin than the Jewish people crucifying and murdering Jesus while denying that he is the Messiah.

These words mean that Mother does not recognize Father as the Messiah and is instead denying that he is the Messiah. These words are a betrayal of Father by Mother - they are Mother denying the Principle, denying Heavenly Father and denying Heavenly Father's lineage.

Those who step out to emphasize the Only Begotten Daughter theology and organize its theory while professing support for these assertions by Mother are also denying the Principle and betraying Father. Moreover, going further, such people are also denying and betraying Hananim (God), who is the one who sent True Father as the Messiah to this world.

When you sympathize with this work, you are not helping Mother. Rather, you are actually causing Mother to get further and further away from the providence of God. Please wake up to the truth that you are only adding to the pain and sorrow now experienced by True Father and Heavenly Father. Please listen to the voice of your conscience in prayer and listen to the sound of pain within True Father's *shimjung* (heart). This is what I hope you can do.

(5) Father's Words

- i. We need to correctly understand the meaning of Father's words that he was born in a place where the original sin was present.

These words by Father are not saying that he had original sin, but that he was born from physical parents who had original sin. That's what we need to grasp.

On the other hand, the parents that gave birth to Father were especially prepared by God; they walked a path of indemnity that allowed them to remove the conditions of Satan's accusation, as previously stated. In the case of Jesus as well, his parents had original sin.

- ii. Mother asserts that she had no original sin, but according to True Father's words, Mother was born with original sin. Father scolded those who said Mother was born without original sin, calling them nutcases and lunatics.
- iii. In all of history, there are only two persons that have been born without original sin, namely Jesus and True Father. Accordingly, fallen humankind must liquidate their original sin through the True Parent (True Father), who comes in the capacity of the Messiah.

Accordingly, as explained in the Principle, the Messiah comes at the completion level of the growth stage. Fallen humankind must pass through the formation stage to the top (completion level) of the growth stage in accordance with the providence of restoration, and passing through the growing period, separate Satan from themselves, remove the fallen nature and ultimately stand in a place that has the form or shape of having been restored, and then meet the Messiah on that foundation.

After removing the original sin through the agency of the True Parent, who is the Messiah, blessed couples must become one with each other and grow further to complete their growth through the completion stage while attending the True Parent, eventually being registered as citizens of the Nation of Cosmic Peace and Unity (Cheon Il Guk) as ideal families, as they were originally created to be.

- iv. True Father said that Mother had followed him well over the years, but in the end, she betrayed him (August, 2011).

At the beginning of 2012, after doing a speech tour in Japan, Mother returned to Las Vegas and said to Father “Well, as far as it goes, I’m not going to go so far as to divorce you.”

Father’s message from spirit world:

Mother has left the position of bride of the Messiah (6 October, 2016).

- v. 8 May, 2010 2:20 am:

Proclamation of True Parents Final Oneness made while attending God

However, even after this time, Mother did not submit herself or unite with Father’s directions (Denial of the Contents of the Proclamation of the Substantial Word of the Settlement of the True Parent of Heaven, Earth and Humankind in Sedona, Arizona).

December 25, 2016 – Mother called in 16 church officials and declared to them that Father had original sin but that Mother was born without original sin as the Only Begotten Daughter.

December 30, 2016 – Mother called in around 100 of the wives of elder couples (430 couple families and above) and again emphasized that Father had original sin, saying that this was removed by Mother and that the True Parents were perfected and completed by Mother. She also said that because of this, Father should not have had any connection with any other woman before he met Mother.

These statements by Mother are exceedingly wrong.

5) Proclamation of the Jubilee Year

- (1) True Father declared a providential jubilee year in 2007, and after establishing King Garden in Hawaii, Father proclaimed the start of the dawning of a new civilization from that location.

After the fall of Adam, civilizations and cultures were divided into Cain and Abel and the providences of the Mediterranean, the Atlantic Ocean and the Pacific Ocean were concluded in the United States of America, the nation bearing the fruits of continental civilization. In Hawaii, the Pacific Rim providence was started centering on True Parents and with Cain and Abel united as one.

Following the proclamation, Father conducted a ceremony for bequeathing the *Pyeong Hwa Shin Gyeong* (Peace Messages). On November 4, 2007, the True Parent offered a special prayer on the summit of Mt. Mauna Kea, after which he moved the providence from Hawaii to Las Vegas in the State of Nevada.

Las Vegas is a place where all the things of Satan's world are brought together and concentrated.

- (2) On January 1, 2008 Father proclaimed the 7.8 Jubilee. On January 13 he declared the day of the Liberation of All Created Things at King Garden in Hawaii, and conducted a special prayer and commemorative tree planting.

After Father proclaimed the start of the new culture, *Wolli Boncheron* (OSDP) and Absolute Sex Education were carried out at King Garden.

(3) Wollli Boncheron (OSDP) Education (October 10, 2008)

i. Prior to Foundation Day

Location: King Garden; **Supervisor:** The True Parent; **Certificate:** True Parents' signature

Title: Education on the Proclamation of Completion of the Realm of Liberation from the Portion of Responsibility in God's Providential History

By teaching *Wollli Boncheron* (OSDP) – Proclamation of the 2010 True Parent's Jubilee

January 1, 2010 – Proclamation of Year One of the Heavenly Calendar, proclamation of Foundation Day (January 13, 2013)

March 27- April 25, 2012 (30 days, Solar Calendar May 17 – June 15)

(Education provided for 3600 Divine Clan Messiahs, followed by 30 day programs in both Japan and USA)

True Father declared that this was the final program and as such, was a special program.

Father's words regarding realization of *Cheon Il Guk* (Nation of Cosmic Peace and Unity)

Father said: Family Federation (Family Messiahs) – Clan Federation (Clan Messiahs) – National Federation (National Messiahs)

In this manner, the education program had to be conducted according to Father's words up until the time of Foundation Day, and on that basis, True Father's Holy Spirit Pentecostal Work would have risen up like a fire and borne fruit.

However, because the *Wollli Boncheron* education program was halted after Father ascended to the spirit world, the flame of Father's Holy Spirit Pentecostal work was extinguished. As a result, Foundation Day was not carried out as per God's desire and plan, in my opinion.

ii. Foundation Day

- Holy Marriage of God
- Transference and Bequeathal of The Royal Seals of God's Kingly Authority
- Registration of Blessed Families of the World into *Cheon Il Guk*

ii. After Foundation Day

- *Wolli Boncheron* (OSDP) Education
- Title: *Wolli Boncheron Absolute Sex Education*

Because the *Wolli Boncheron* (OSDP) Absolute Sex Education program was not conducted, a great deal of confusion and misfortune has been experienced by our church, the Family Federation for World Peace and Unification.

Conclusion

Our families must attend the True Parent (True Father) and form the Abel Clan Federation through conducting *Wolli Boncheron Absolute Sex Education*, then conduct *Wolli Boncheron Absolute Sex Education* programs for Cain clans, bless them with the Marriage Blessing, and find and establish God's homeland through home church.

Each family must bring to completion *hoondok* home churches that practice an active *hoondok* life in attendance to God and the True Parent.

What We Must Do

○ True Parent

When we talk about the True Parent, we mean the substantial True Father (CSS Vol. 208 pg. 77).

Mother is the True Father's wife. When Mother becomes one with the True Parent, then she becomes a True Parent with him.

○ Church (*kyo-hwe*) (교회)(教會)

The *kyo* character in *kyo-hwe* ('church') indicates that the church is a place where the Father is taught, and where we gather in order to teach the way of filial attendance to the Father. Home Church ('Family Church') is what we do in order to achieve that purpose in the home (family). (NOTE: the Chinese characters used to express 'church' in Korea combine the character for educate and the character for gather.)

○ Salvation

Salvation is not completely accomplished by believing in Jesus. One must receive substantial salvation in both spirit and flesh through the blessing of the True Parent. Of those who believe in Jesus, none have yet entered into the Kingdom of Heaven.

○ Home Church (Family Church)

For home church to be accomplished, each family must practice hoondok of God's word and become a hoondok family church.

In this manner, Cheon Il Guk can be completed and perfected in substance.

If and when we practice hoondok of the Eight Great Textbooks, which is the Word of God revealed by True Father after he fought with the myriads of Satanic forces, Satan will be unable to invade no matter how much he may seek to undermine our work.